

# Front wheel suspension

240, 260

Section

6

Groups

60, 61

Front wheel  
suspension

240, 260

# VOLVO

# Contents

	Page	Step
Specifications .....	1	
Special tools .....	2	
Illustrations .....	4	
<b>Group 60: General</b>		
Wheel alignment .....	6	A1-A21
<b>Group 61: Front wheel suspension</b>		
Replacing steering swivel ball joints:		
– early prod. ....	11	B1-B33
– late prod. ....	19	C1-C12
Replacing strut upper journal .....	23	D1-D20
Replacing control arms and/or bushings		
Vehicle on rail lift .....	28	E1-E20
Replacing front control arm rear bushing:		
– vehicle on rail lift .....	33	F1-F10
– vehicle on floor .....	36	G1-G15
Replacing front shock absorber .....	40	H1-H25
Replacing front coil spring .....	46	I1-I25

**TP 30 000 / 1**

4500.3.79

Printed in USA

# Specifications

## Wheel alignment (unloaded car)

Caster: (All cars up to and including 1978 year models) .....	+2° to +3°
1979 year models with manual steering .....	+2° to +3°
1979 year models with power steering .....	+3° to +4°
Camber set as near 0° as possible .....	0 to +1°
King pin inclination at 0° camber .....	12°
Turning angles: At 20.0° turning of outer wheel, inner wheel should be turned 20.8°	

## Toe-in:

	Angle (2 $\alpha$ )	A-a (mm)	B-b (mm)	C-c (mm)
Manual steering	24' ± 8'	4.5 ± 1.5	3.5 ± 1	2.5 ± 1
Power steering	16' ± 8'	3.0 ± 1.5	2.0 ± 1	1.5 ± 1

All measurements are made with the car unloaded. The measurements are taken at hub height, as the angle measurement  $\alpha$ , or the difference in mm between the front and rear edge of the wheels at points A, B or C (the tire's wear thread inside shoulder or rim corner).

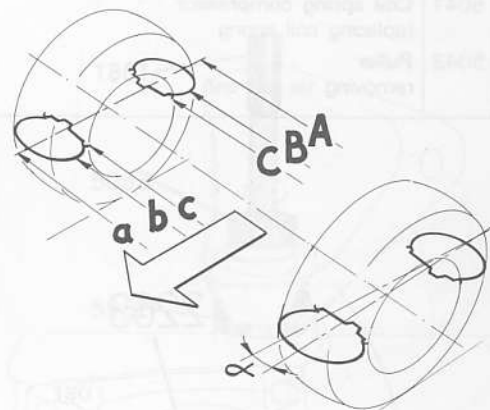

112 486

## Ball joints

Max. axial play with normally loaded front end:  
1/8" (3 mm).

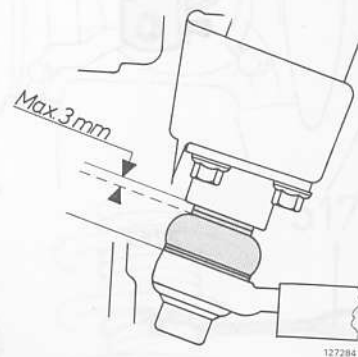

127284

## Tightening torques

	Nm	Ft. lbs.
Nut for control arm rear bushing .....	55 ± 5	40 ± 4
Bracket for control arm rear bushing .....	40 ± 10	29 ± 7
Front bolt for control arm bushing .....	75 ± 20	54 ± 14
Ball joint, to control arm .....	115 ± 15	83 ± 11
Ball joint to attachment or strut .....	60 ± 10	43 ± 7
Ball joint attachment to strut .....	23 ± 5	17 ± 4
Steering rod to steering arm .....	60 ± 10	43 ± 7
Nuts for upper journalling .....	20 ± 5	14 ± 4
Steering wheel nut .....	60 ± 15	43 ± 11
Wheel nuts .....	120 ± 20	87 ± 9

## Special tools

1801	<b>Standard handle</b>
2263	<b>Puller</b> removing steering wheel
5036	<b>Socket</b> shock absorber shaft nut
5037	<b>Socket</b> to retain shock absorber shaft when removing and tightening nut
5038	<b>Adjustment tool</b> front end alignment
5039	<b>Spanner</b> shock absorber nut on strut (hydraulic shock absorber)
5040	<b>Coil spring hook-up tool</b> removing and installing coil spring
5041	<b>Coil spring compressor</b> replacing coil spring
5043	<b>Puller</b> removing tie rod end

5045	<b>Retaining hook</b> for control arm when replacing shock absorber
5081	<b>Adapter</b> pressing in control arm rear bushing
5082	<b>Adapter</b> pressing out/in control arm rear bushing
5083	<b>Adapter</b> pressing in control arm rear bushing
5084	<b>Adapter</b> pressing in control arm front bushing
5085	<b>Adapter</b> pressing out/in control arm front bushing
5091	<b>Adapter</b> pressing out control arm front bushing
5173	<b>Wrench</b> shock absorber nut on strut (gas-pressure shock absorber)

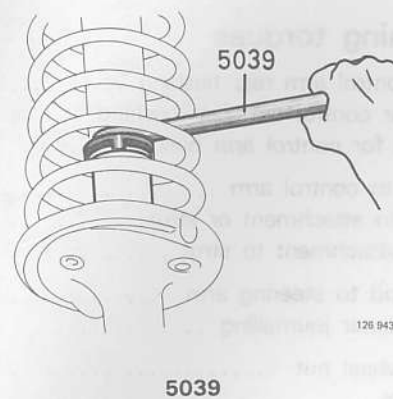
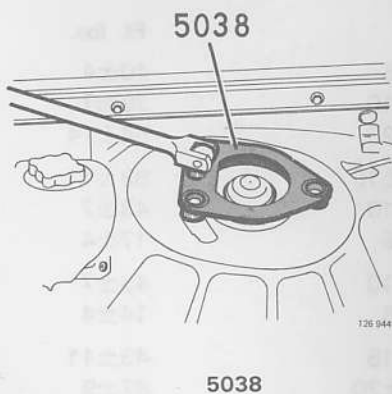
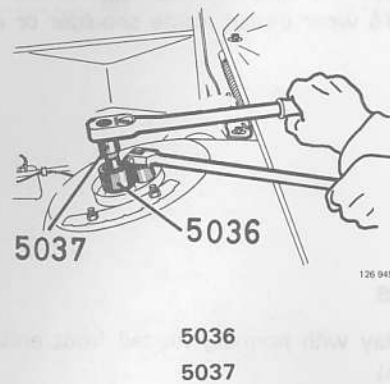
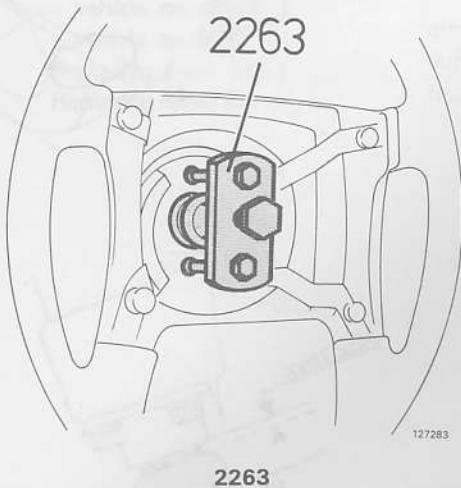

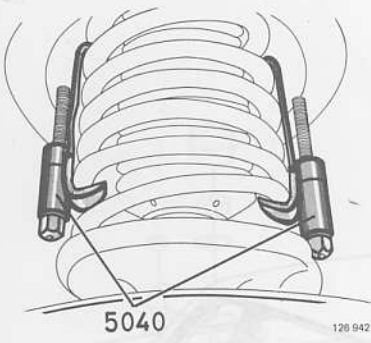

5040

126 942

5040



5041

126 941

5141

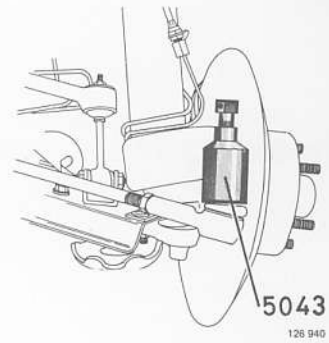

5043

126 940

5043

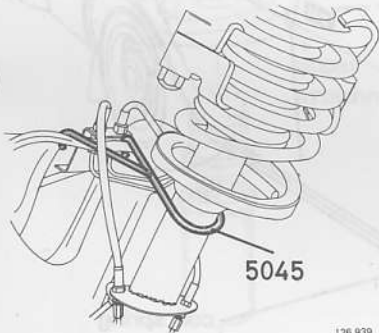

5045

126 939

5045

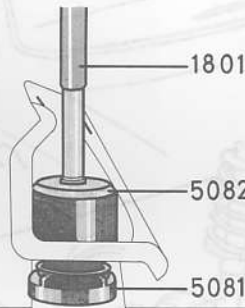

1801

5082

5081

126 938

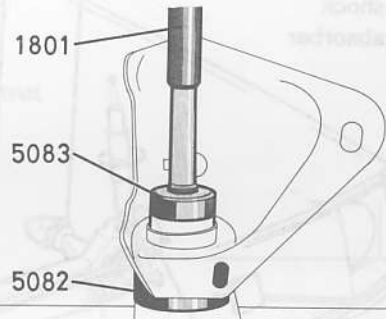

1801

5083

5082

126 937

1801  
5081  
5082  
5083

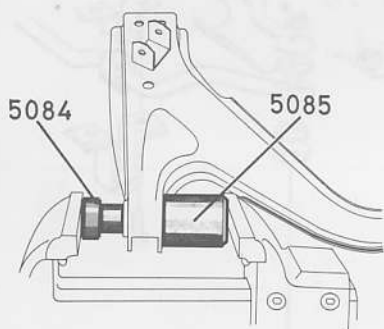

5084

5085

126 936

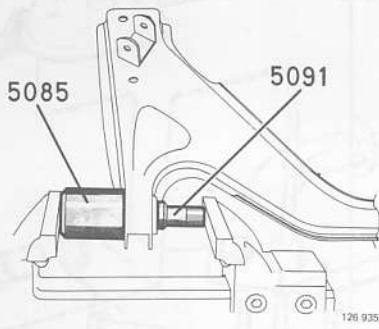

5085

5091

126 935

5084  
5085  
5091

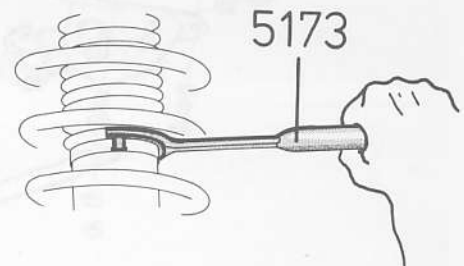

5173

127282

5173

Special tools

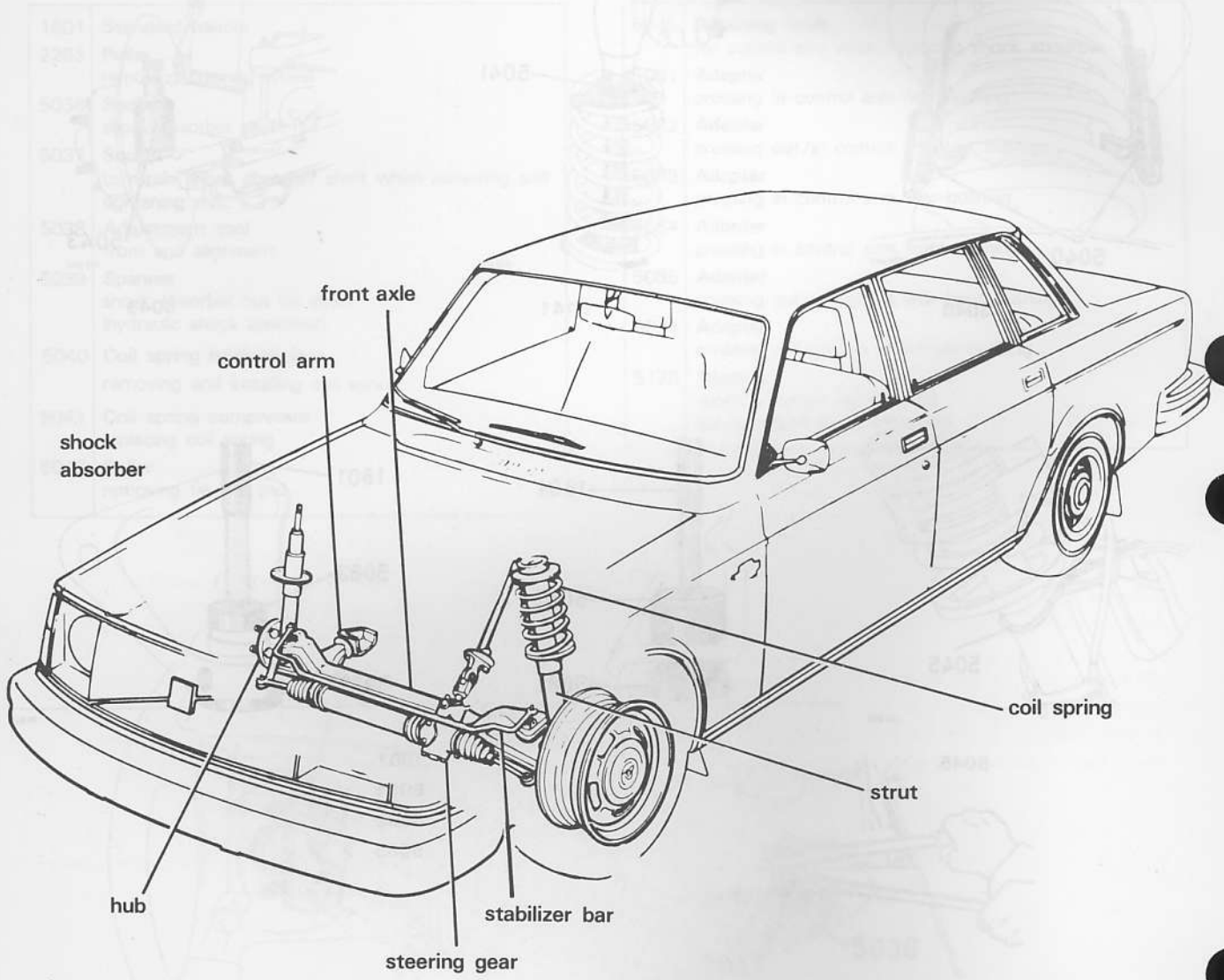

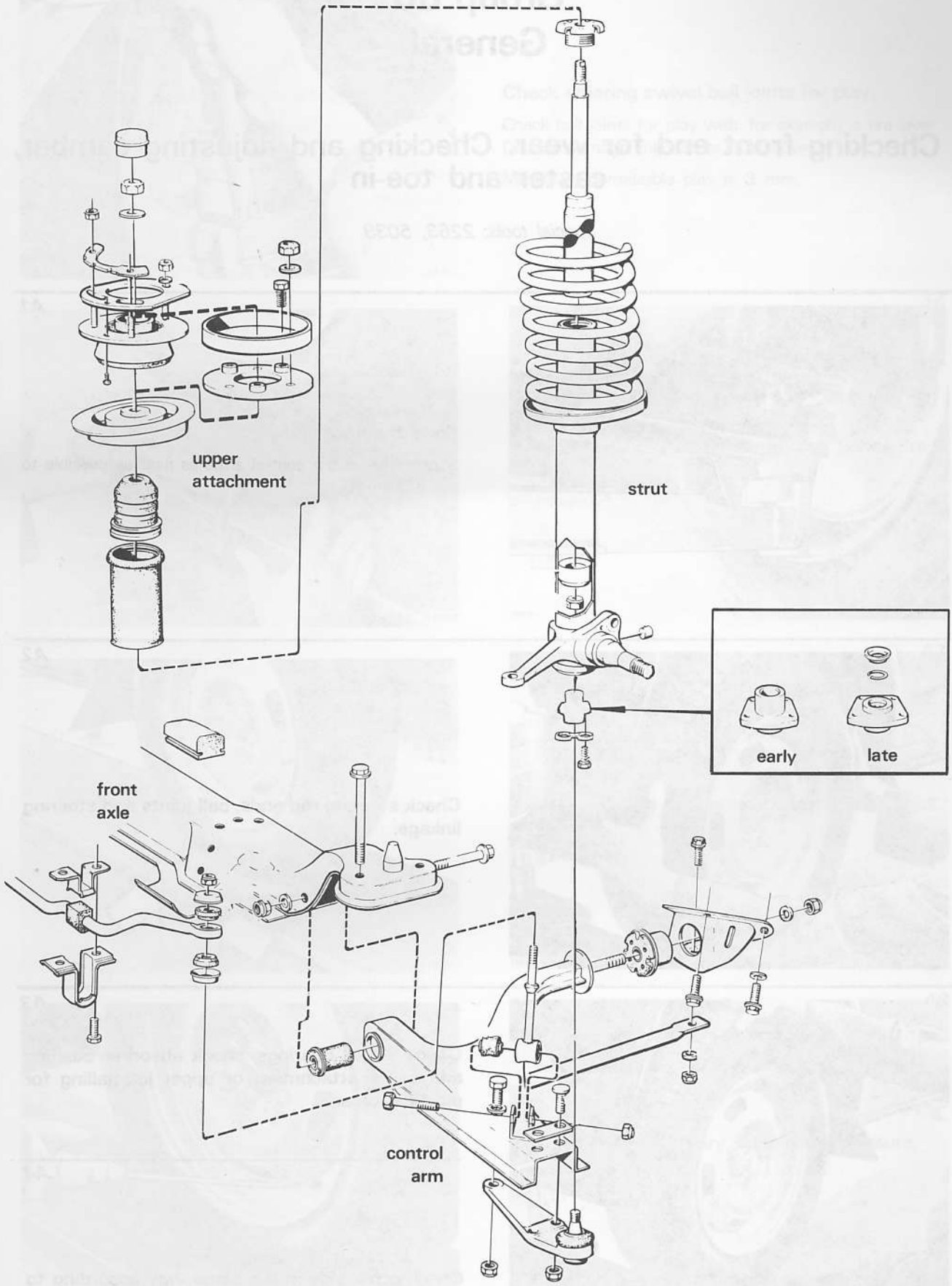

## Group 60 General

### Checking front end for wear. Checking and adjusting camber, caster and toe-in

Special tools: 2263, 5038

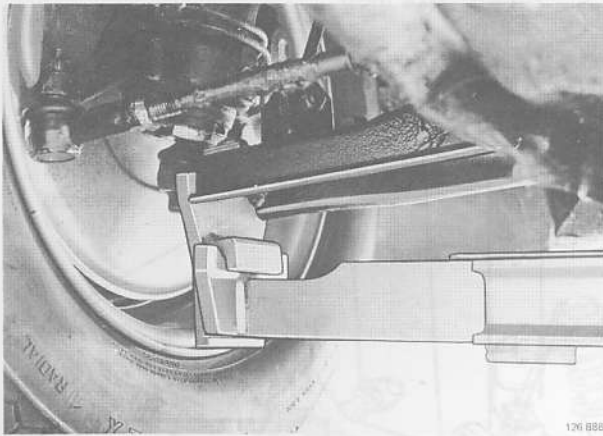

A1

**Raise the front end.**

Support under the control arms as near as possible to the ball studs.



A2

**Check steering rod ends, ball joints and steering linkage.**



A3

**Check wheel bearings, shock absorber bushing and upper attachment or upper journaling for play and wear.**

A4

**Check other side in the same way according to A2-A3.**



A5

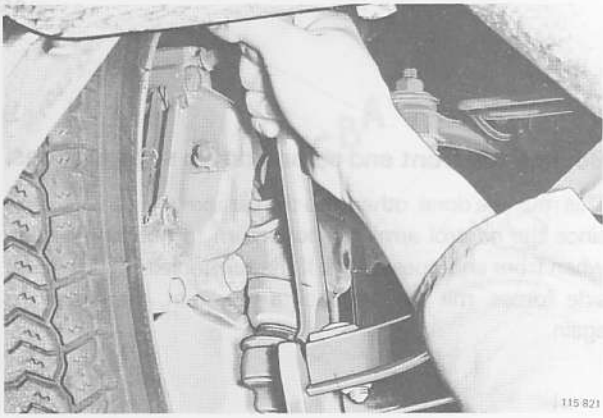

**Check steering swivel ball joints for play.**

Check ball joints for play with, for example, a tire lever. Do not damage the rubber dust cover.

Maximum permissible play is **3 mm**.

A6

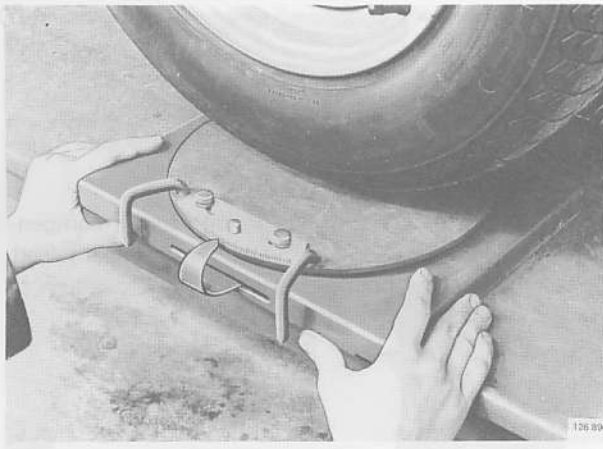

**Place wheel alignment turntables under front wheels.**

A7

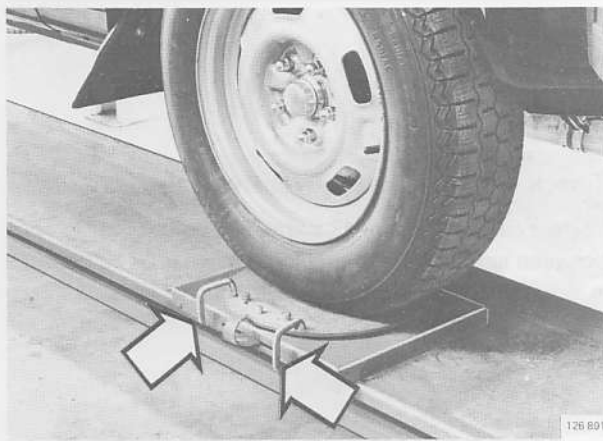

**Lower front end and remove turntable catches.**

A8

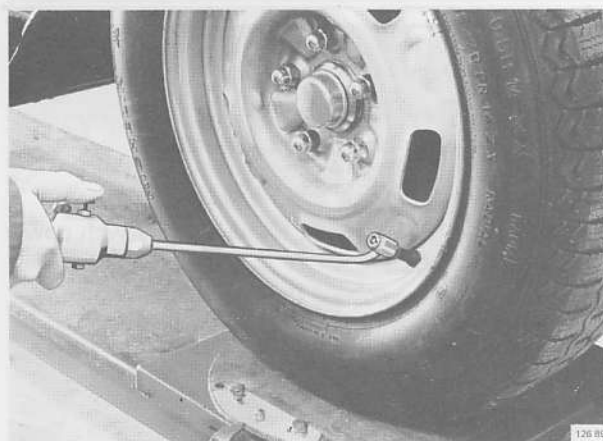

**Check, and if necessary, adjust tire pressure.**

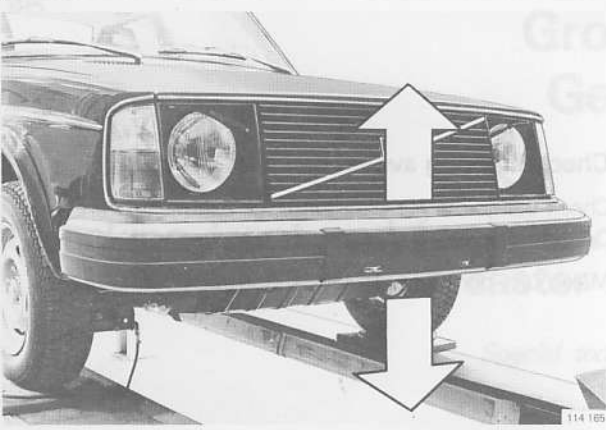

**Bounce the front end up and down several times.**

This must be done, otherwise the camber will be excessive since the control arms do not return to normal position when front end goes down. If the turntables cannot stand side forces, roll the car back a few feet, then forward again.

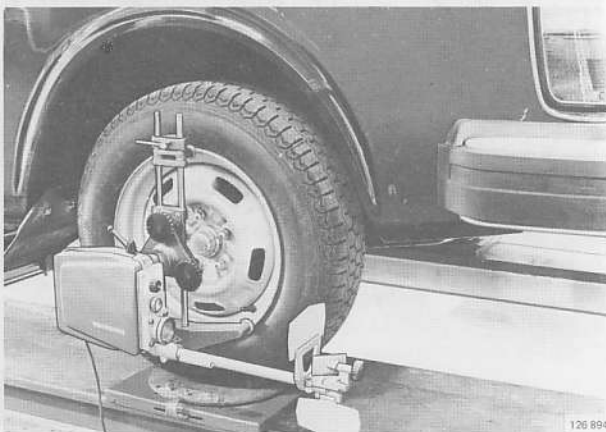

**Install projectors.**

Follow the instructions for equipment used. If compensation for rim warp is made with front wheels raised, front end must be bounced several times to return to correct position.

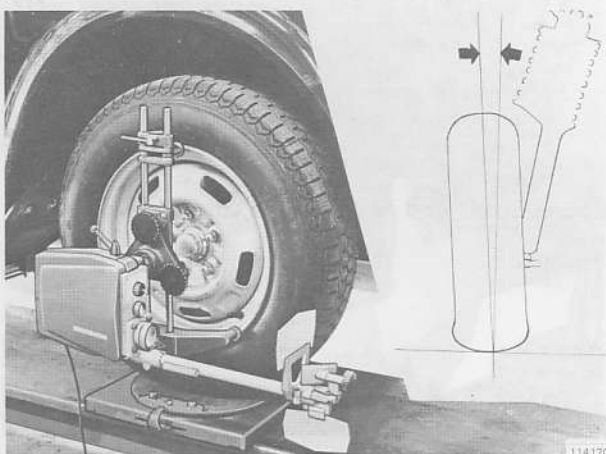

**Check camber on both front wheels.**

Correct camber: **max. +1°**, not to exceed 1/2° difference between sides. Camber should be as near 0° as possible in order to avoid shoulder wear on the tires.

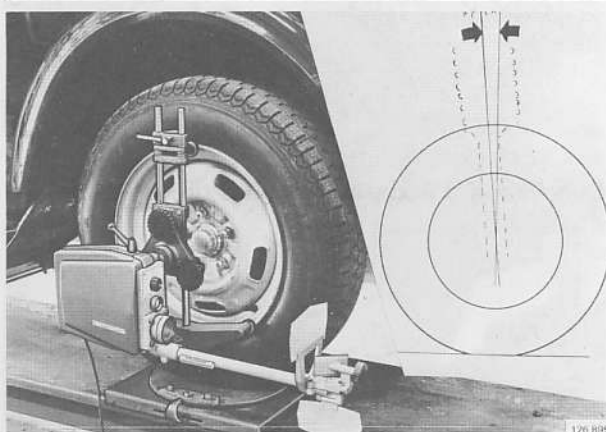

**Check caster on both front wheels.**

Correct caster: **+2° to +3°.**

Effective with 1979 models, caster on cars with power steering is **+3° to +4°.**

Caster cannot be adjusted. If caster angle is incorrect, front end components must be checked.

**Toe-in**

A13

The toe-in should be set as follows:

		Angle $2\alpha$	A-a	B-b	C-c
240 series	manual steering	$24' \pm 8'$	$4.5 \pm 1.5$ mm $3/8"$ ( $0.18 \pm 0.06"$ )	$3.5 \pm 1$ mm ( $0.14 \pm 0.04"$ )	$2.5 \pm$ mm ( $0.10 \pm 0.04"$ )
240 series	power steering	$16' \pm 8'$	$3.0 \pm 1.5$ mm $1/8"$ ( $0.12 \pm 0.06"$ )	$2.0 \pm 1$ mm ( $0.08 \pm 0.04"$ )	$1.5 \pm 1$ mm ( $0.06 \pm 0.04"$ )

Vehicle should not be loaded. Measurements must be made at center (hub) height,  $\alpha$  as in an angle, read on certain instruments. A, B and C refer to tire outer diameter, tire inner shoulder and rim, respectively.

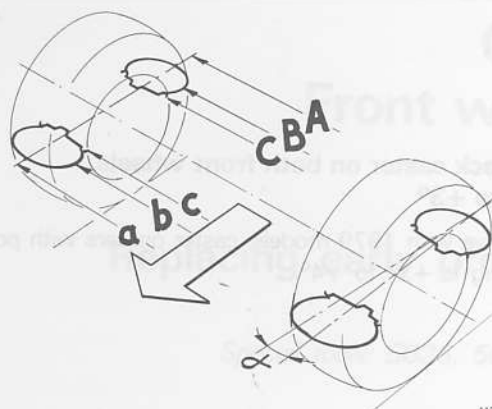

117 486

A14

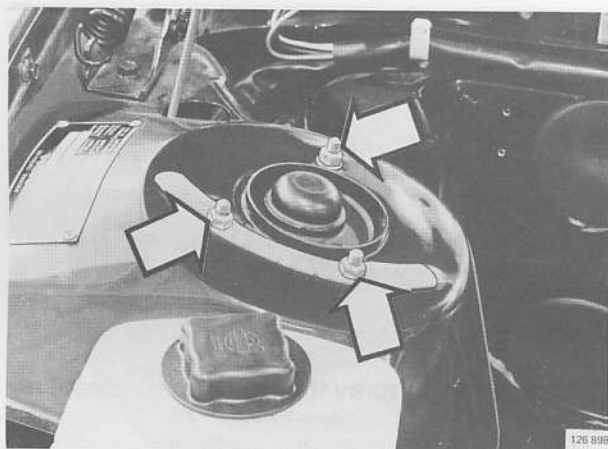

126 898

To adjust, proceed as follows:

Remove nuts on strut upper attachment.

A15

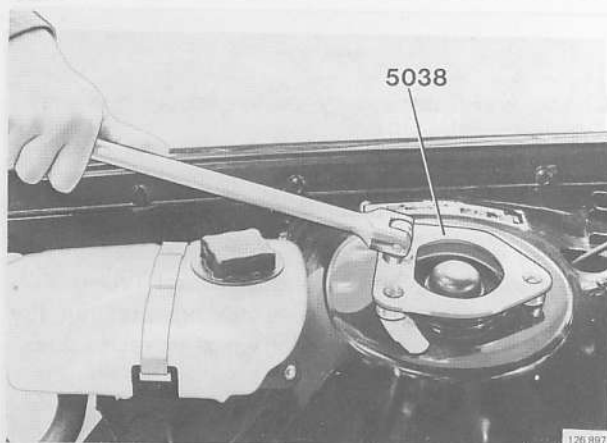

126 897

**Adjust camber:**

Use tool **5038**.

Correct camber: **max. +1°**. Max. 0.5° difference between right and left wheels. Camber should be as near 0° as possible to avoid shoulder wear on tires.

A16

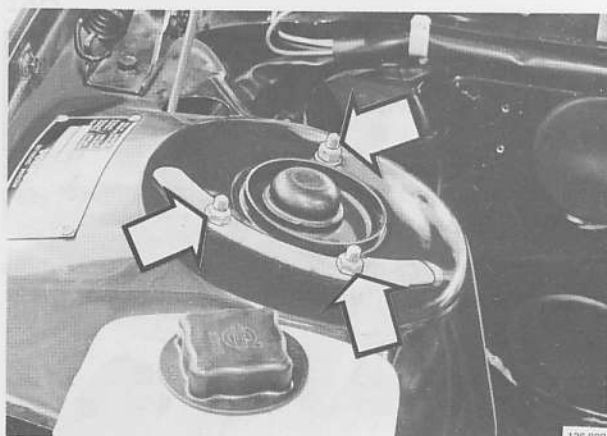

126 898

**Install and tighten nuts for upper attachments.**

Torque: **20 ± 5 Nm = 14 ± 4 ft.lbs.**

A17

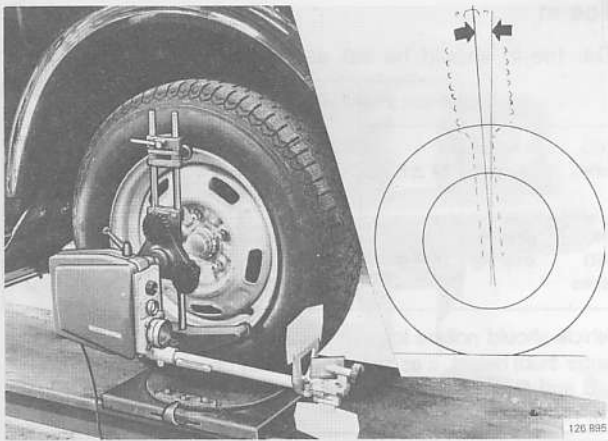

**Recheck caster on both front wheels.  
+2° to +3°**

Effective with 1979 models, caster on cars with power steering is +3° to +4°.

A18

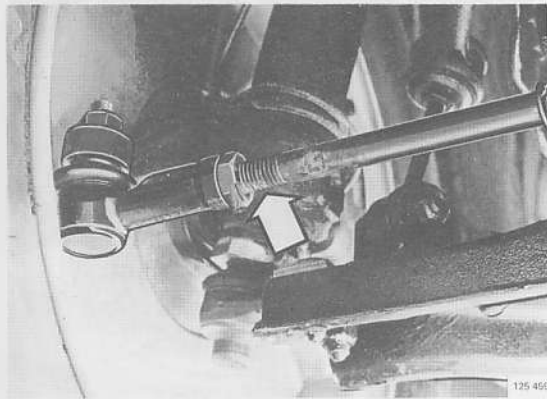

**Adjusting toe-in:**

Loosen lock nuts and adjust toe-in with steering rods. Correct toe-in: see A13.

Steering rods must not differ more than **2 mm** in length. Measure between wrench grip and lock nut.

A19

**Tighten nuts and spray threads with rustproofing oil.**

A20

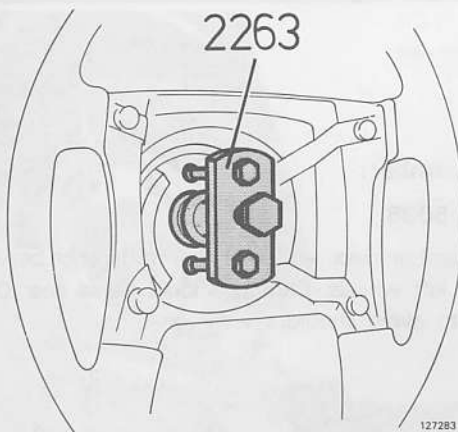

**Check, and if necessary, adjust steering wheel position.**

Carefully pry impact pad loose with screwdriver. Remove steering wheel with puller **2263**.

No puller is needed to remove steering wheel on 1979 year models. However, a special socket (Volvo P/N 1158146) is required to remove steering wheel nut. Pry cover washer in center of steering wheel with screwdriver.

A21

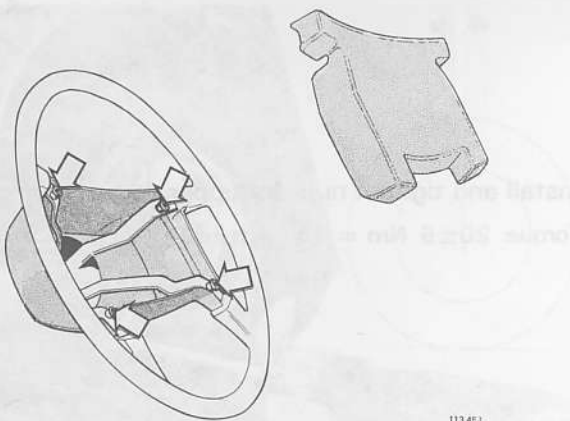

**Install steering wheel.**

Torque: **60±15 Nm = 43±11 ft.lbs.**

Coat insulation pins with vaseline and press impact pad securely into position.

Effective with 1979 models, a thin wall socket, 27 mm, is required to tighten the steering wheel.

## Group 61 Front wheel suspension

### Replacing early prod. steering swivel ball joints

Special tools: 5036, 5037, 5039, 5040, 5043, 5045, 5173

B1



#### Support front end on stands.

Place stands under front jack attachments.  
Mark front wheels to avoid rebalancing.  
Remove front wheels.

B2

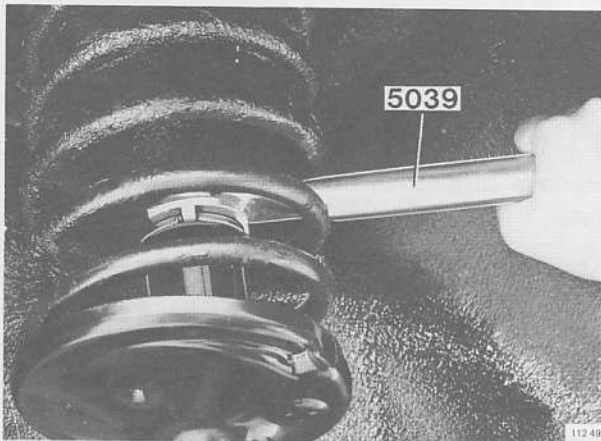

#### Loosen shock absorber retaining nut a couple of turns.

Use tool **5039** for standard (hydraulic) shock absorber  
and **5173** for gas-pressure shock absorber.

B3

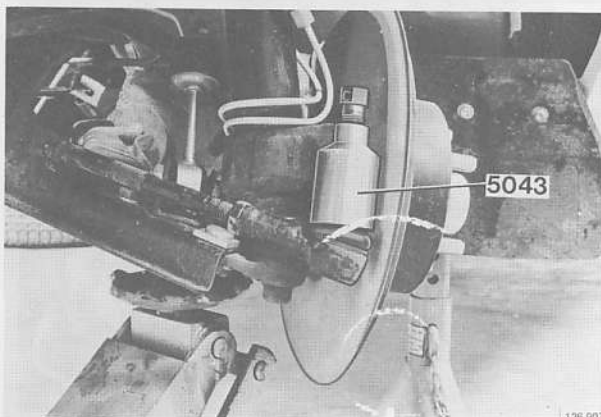

#### Place jack under control arm, disconnect steering rod from steering arm.

Remove nut and detach rod with **5043**.

B4

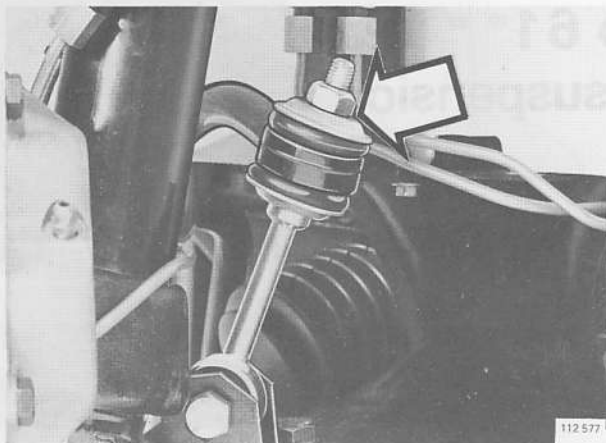

Disconnect stabilizer bar from stabilizer link upper attachment.

B5

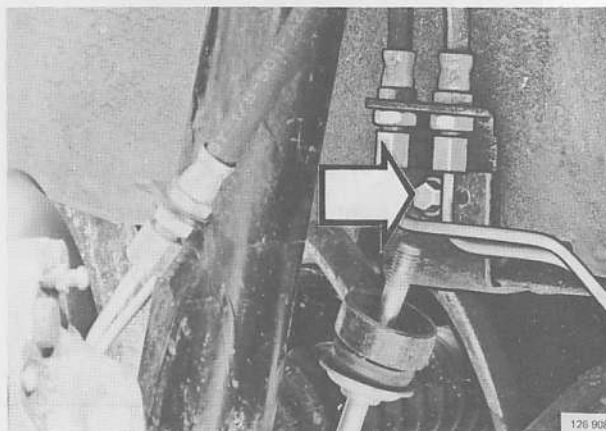

Remove brake pipe bracket bolt.

B6

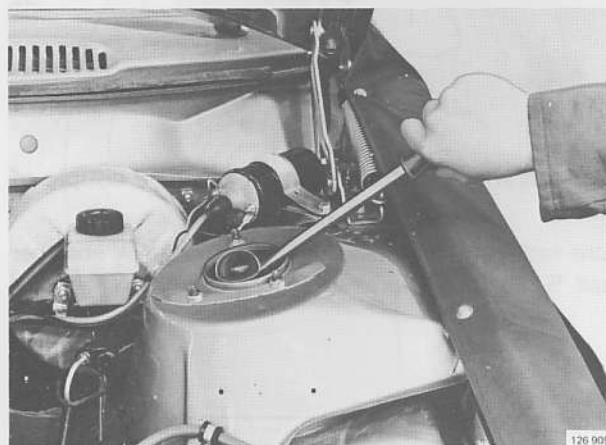

Remove protective cover over shock absorber nut.

Pry loose with screwdriver.

B7

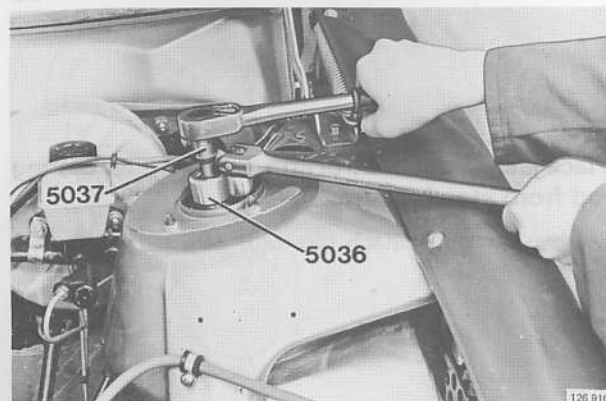

Loosen center nut.

Loosen nut several turns with **5036**. Hold shock absorber plunger rod with **5037**.

B8

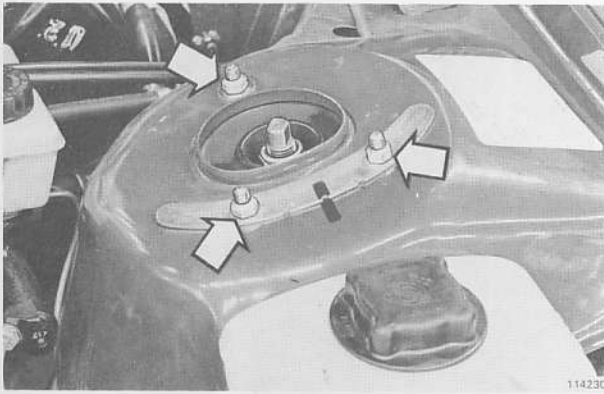

**Line-mark upper journal position and remove nuts.**  
Line-mark over nut plate and wheel housing plate as illustrated.

B9

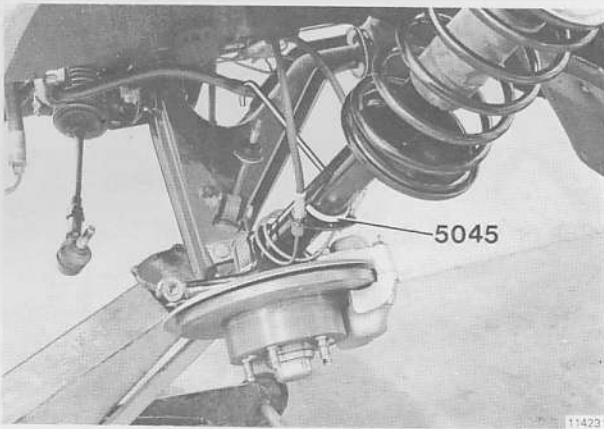

**Lower jack and guide out spring assembly.**  
Hook spring assembly to shock absorber with retaining hook 5045.

B10

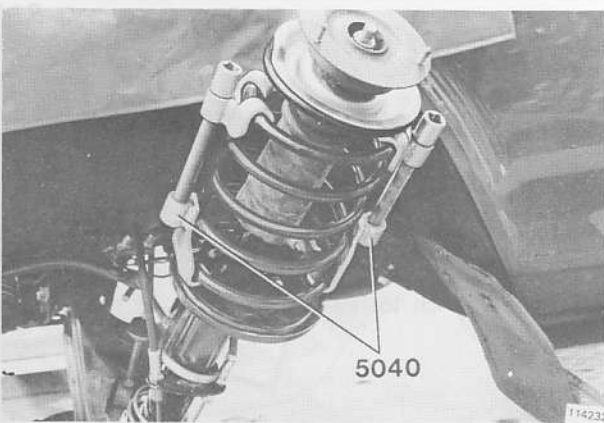

**Use tool 5040 to compress spring.**  
Place the two hook-up tools opposite each other and with three spring coils free between the claws. Compress alternately.

B11

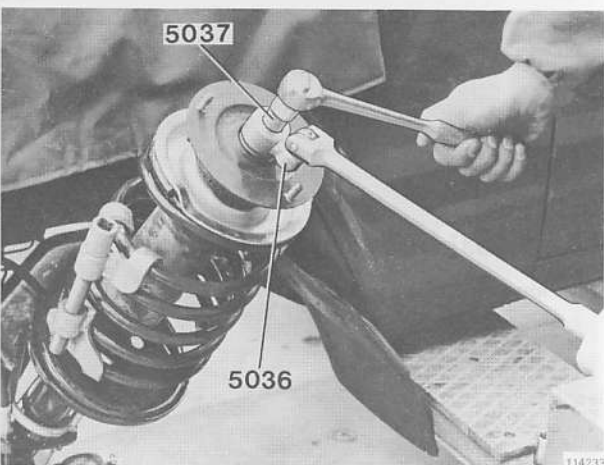

**Remove center nut, lift off upper journal.**  
Use tool 5036 to remove nut. Hold shock absorber with 5037.

B12

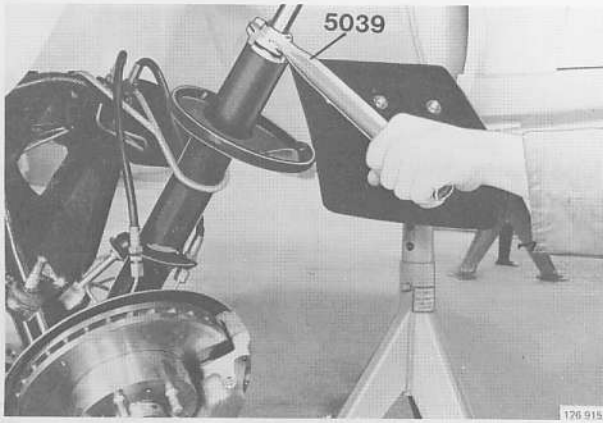

**Remove shock absorber retaining nut.**

Use tool **5039** for standard (hydraulic) shock absorber and **5173** for gas-pressure shock absorber.

B13

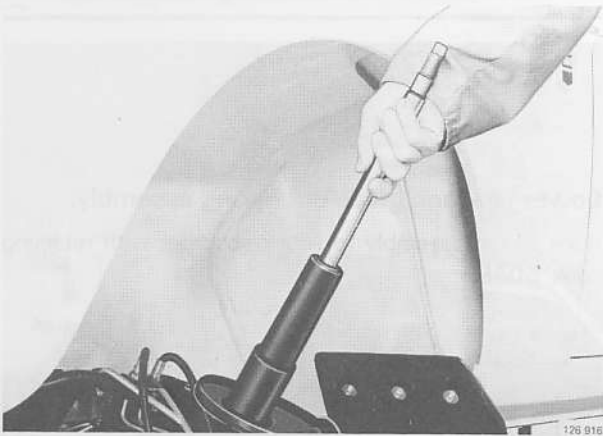

**Pull up shock absorber.**

B14

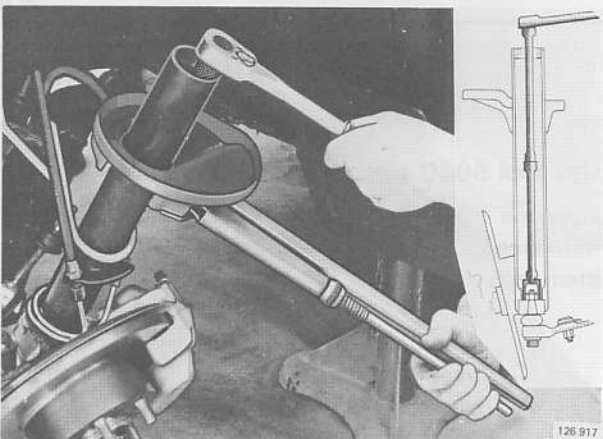

**Loosen ball joint retaining nut.**

Loosen a few turns until ball joint bracket comes loose. Use **19 mm** socket.

Use pipe wrench to hold on the weld.

B15

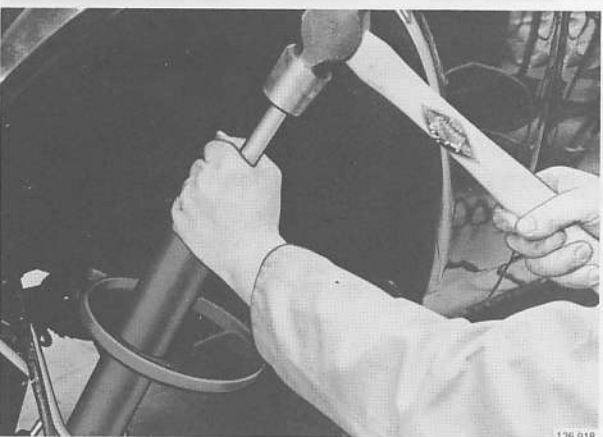

**Loosen ball joint conical part from strut assembly.**

Use long brass drift and hammer.



B16

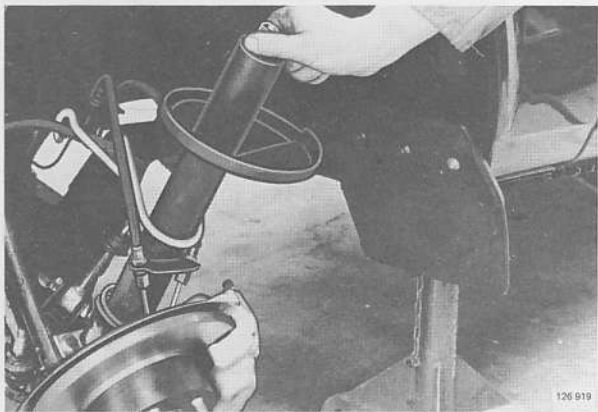

**Remove nut.**

Coat inside of socket with vaseline or similar lubricant so nut may be lifted when loose from thread.

B17

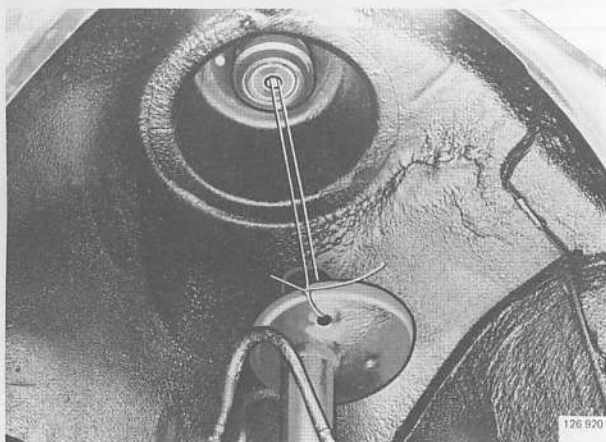

**Hang up strut assembly.**

Use steel wire to hang strut assembly to upper attachment. Remove hook. Disconnect ball joint from strut assembly.

Do not stretch or damage brake hoses.

B18

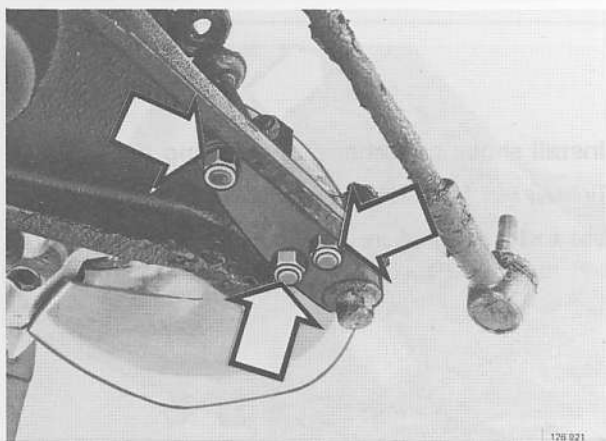

**Disconnect ball joint from control arm.**

B19

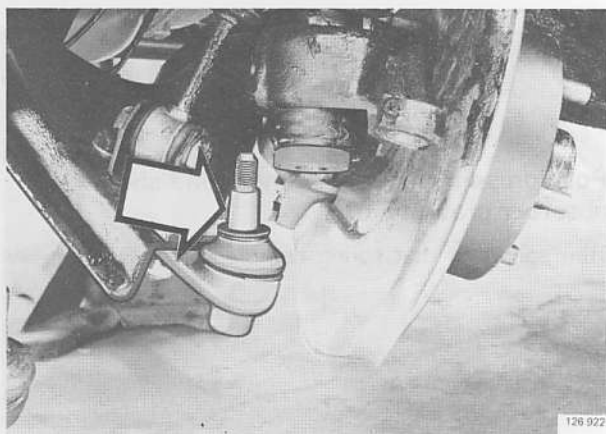

**Attach new ball joint to control arm.**

Torque:  $115 \pm 15$  Nm =  $83 \pm 11$  ft.lbs.

Clear grease from ball joint. If this is neglected, stud can be tightened too far into cone so that rubber bellow sticks to strut.

B20

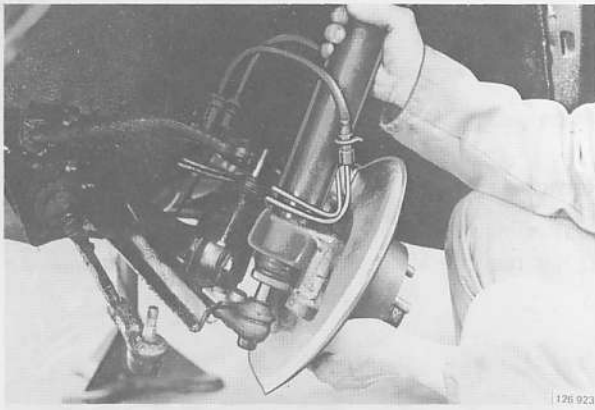

**Lift strut assembly onto ball joint.**

Remove wire and hook up retaining hook 5045.

B21

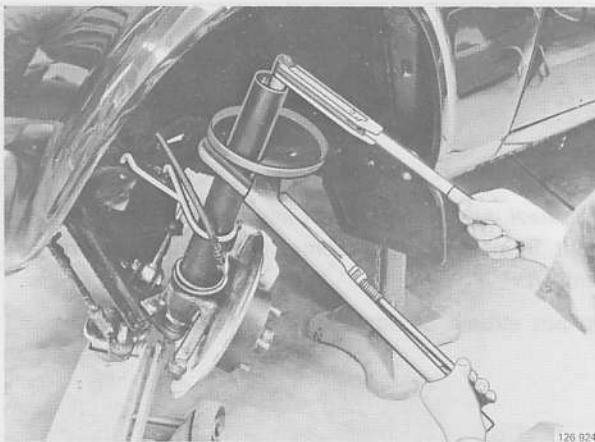

**Install ball joint nut.**

Torque:  $60 \pm 10$  Nm =  $43 \pm 7$  ft.lbs.

Hold with pipe pliers around the weld.

B22

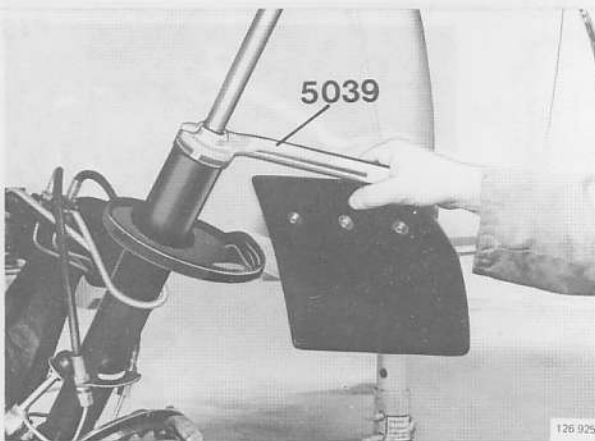

**Install shock absorber and retaining nut.**

Tighten nut as much as possible without turning strut.

Use tool 5039 for standard (hydraulic) shock absorber  
and tool 5173 for gas-pressure shock absorber.

B23

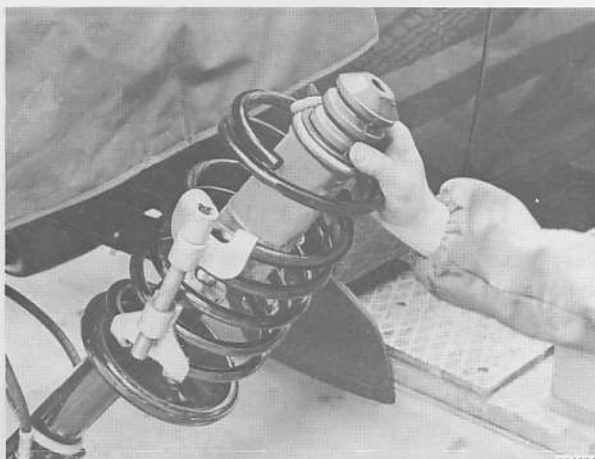

**Position spring, rubber bumper and shock absorber protection.**

Turn spring so that spring compressor claws face up.

B24

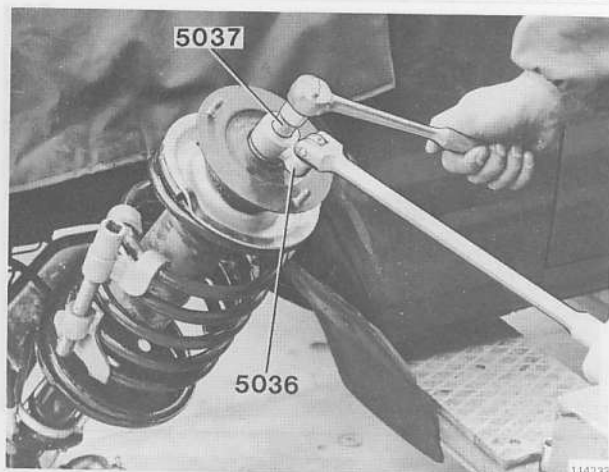

**Install spring seat, upper journal, washer and nut.**  
Tighten nut with **5036** and hold with **5037**.

B25

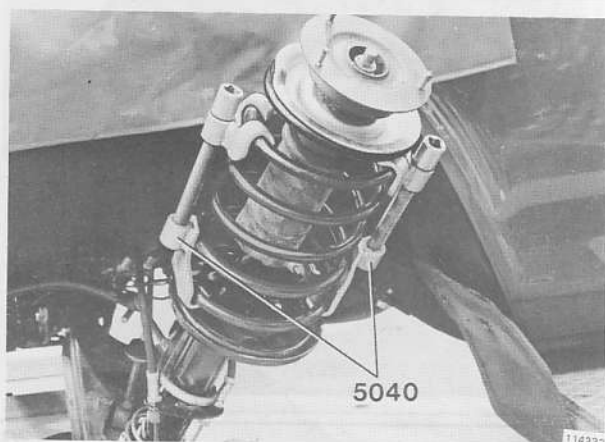

**Remove spring compressor.**  
Loosen spring compressor bolts alternately. Make sure spring ends seat correctly in upper and lower seats.

B26

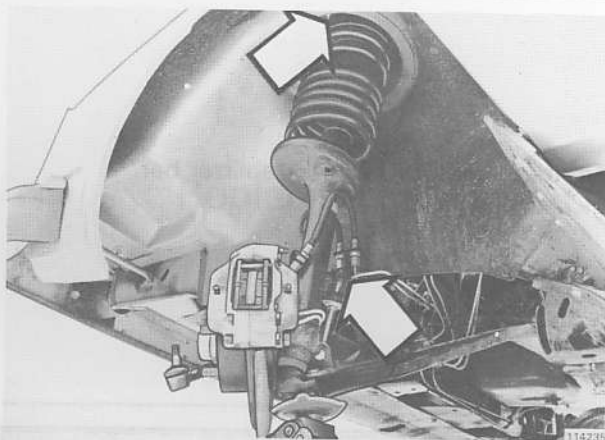

**Guide strut assembly into upper attachment in wheel housing.**  
Remove retaining hook and raise jack. Make sure stabilizer link is guided into position.

B27

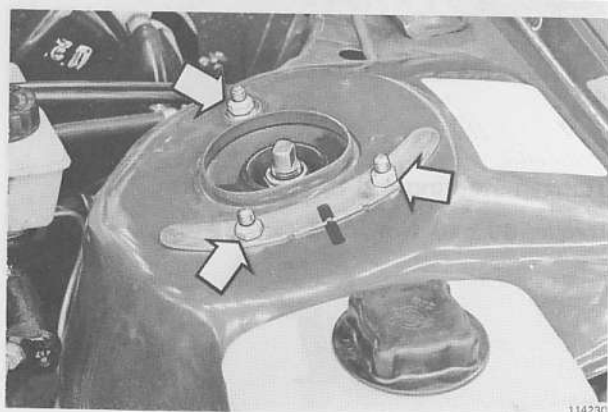

**Turn journal to correct position and tighten nuts.**  
Position journal according to line-up marks.  
Torque:  $20 \pm 5 \text{ Nm} = 14 \pm 4 \text{ ft.lbs.}$

B28

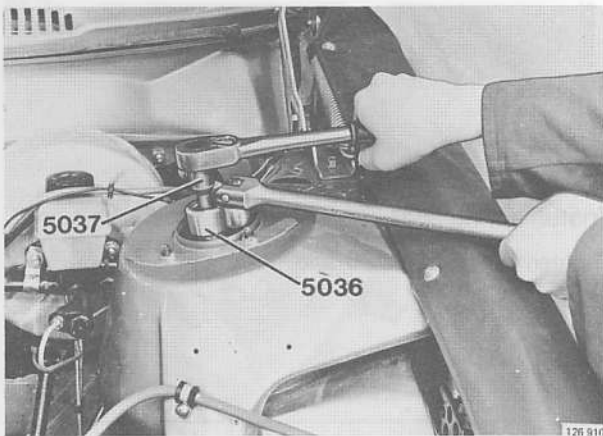

**Tighten shock absorber retaining nut.**  
Tighten nut with **5036** and hold with **5037**.  
Press protective cover into position.

B29

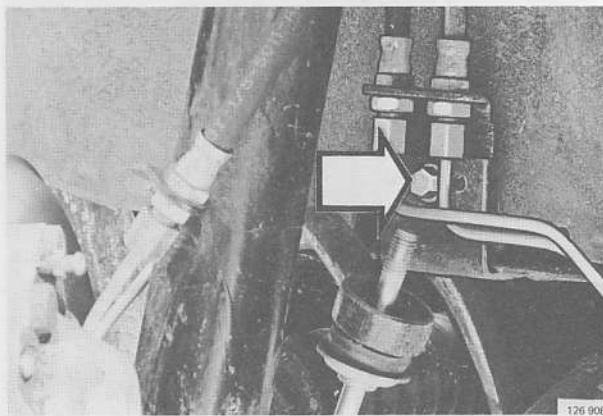

**Tighten brake pipe bracket bolt.**

B30

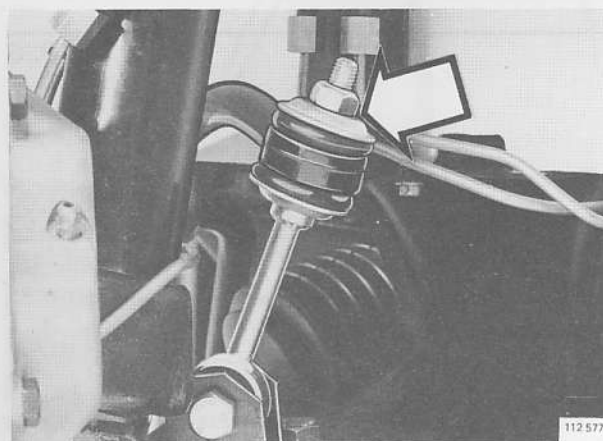

**Tighten stabilizer link to stabilizer bar.**

B31

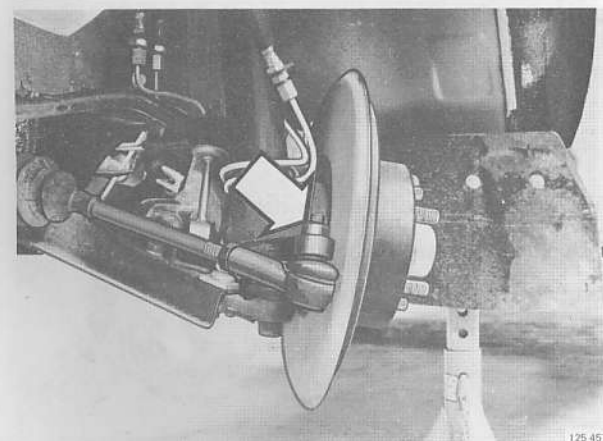

**Tighten steering rod to steering arm.**  
Torque:  $60 \pm 10$  Nm =  $43 \pm 7$  ft.lbs.

B32

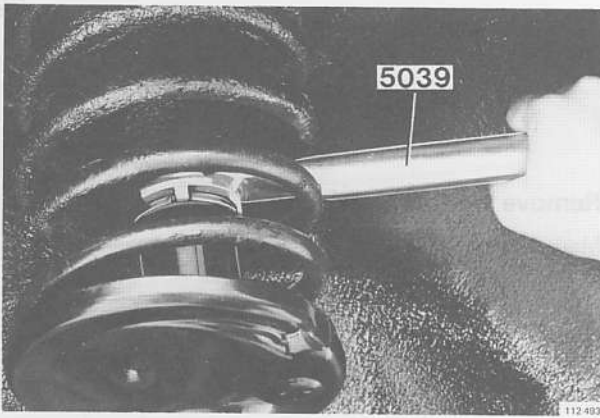

**Tighten shock absorber nut in strut assembly.**

Use tool **5039** for standard (hydraulic) shock absorber and tool **5173** for gas-pressure shock absorber.

B33



**Install front wheel.**

Use the marks made previously.

Torque:  $120 \pm 20$  Nm =  $87 \pm 9$  ft.lbs.

## Replacing late prod. steering swivel ball joint

*Special tools: 5039, 5173*

C1

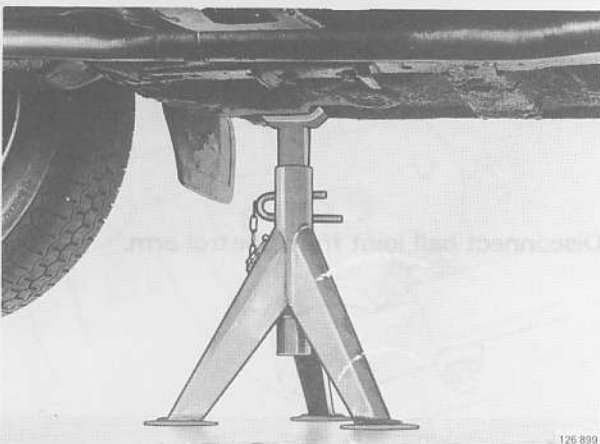

**Support front end on stands.**

Place stands under front jack attachments.

C2



**Remove front wheels.**

Mark location to avoid re-balancing.

C3

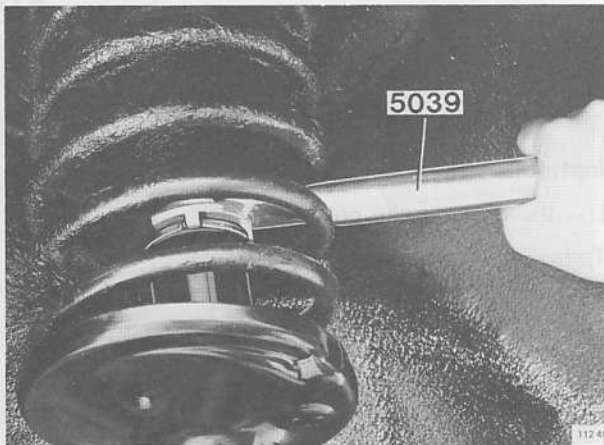

**Loosen shock absorber retaining nut a couple of turns.**

Use tool **5039** for standard (hydraulic) shock absorber and **5173** for gas-pressure shock absorber.

On vehicles from 1978 models it is not necessary to loosen the shock absorber retaining nut. The shock absorber does not rest against ball joint attachment.

C4

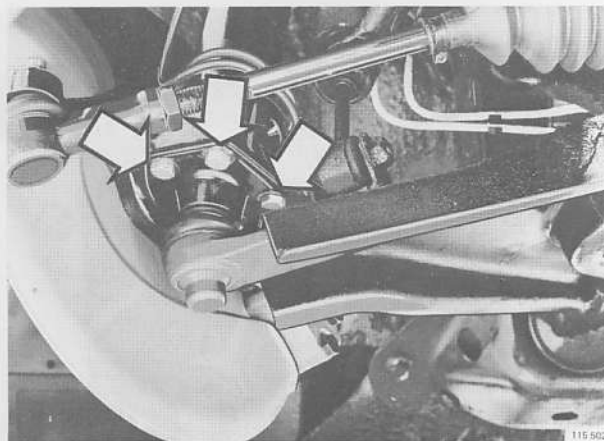

**Remove four retaining bolts for ball joint attachment.**

If bolts are secured with lock washers, first pry these loose with a screwdriver.

C5

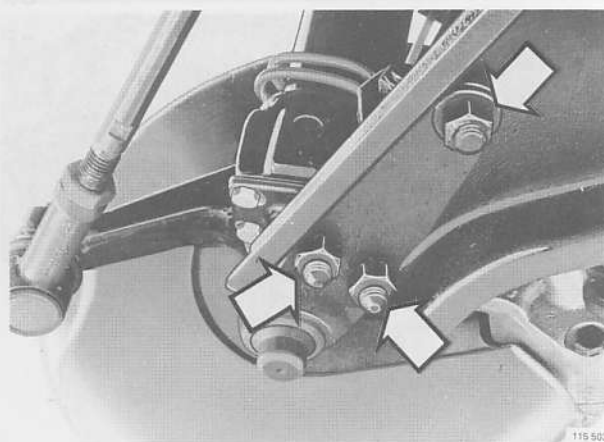

**Disconnect ball joint from control arm.**

C6

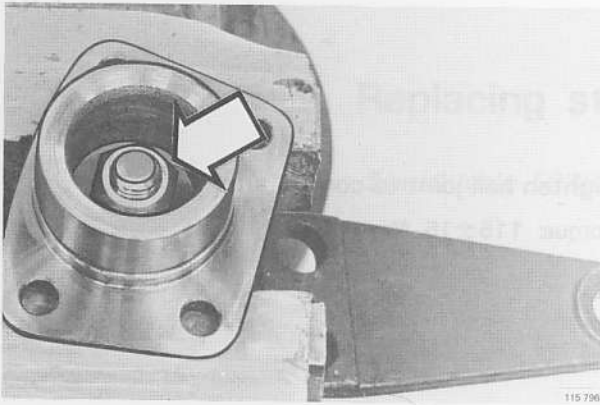

Remove ball joint retaining nut.

C7



Press ball joint out of attachment.

C8

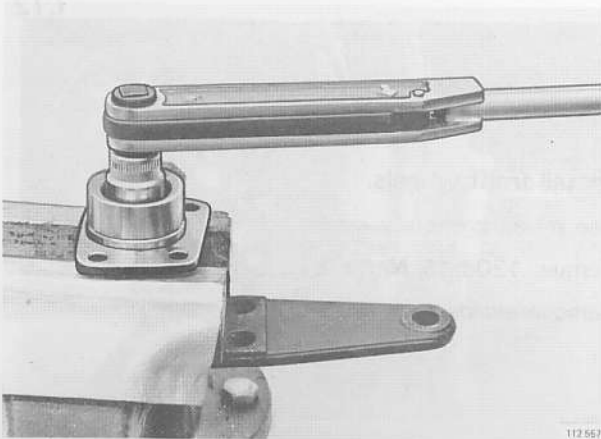

Attach the new ball joint.

Torque:  $60 \pm 10 \text{ Nm} = 43 \pm 7 \text{ ft.lbs.}$

Remove grease from ball joint stud. Otherwise it can be tightened too far into cone so that rubber bellow sticks to attachment.

Effective from 1979 models with power steering, ball joints are different for left and right sides. Compared to previous years, ball joint is 10 mm forward in control rod attachment. It is therefore most important that these ball joints are installed on correct side.

C9

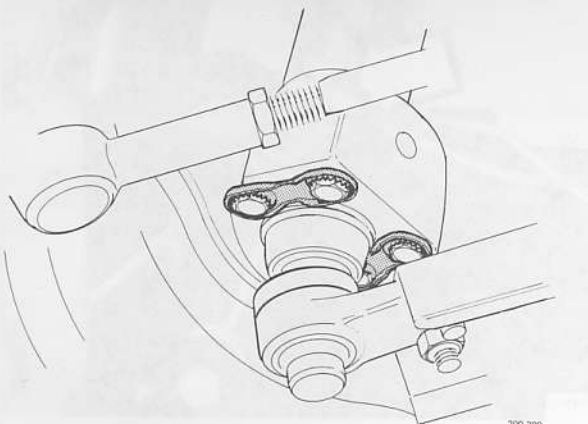

Attach ball joint to spring assembly.

Use new lock bolts. On vehicles equipped with lock washers (see step C4), new lock washers must be used. P/N 1229417.

Torque:  $23 \pm 5 \text{ Nm} = 17 \pm 4 \text{ ft.lbs.}$

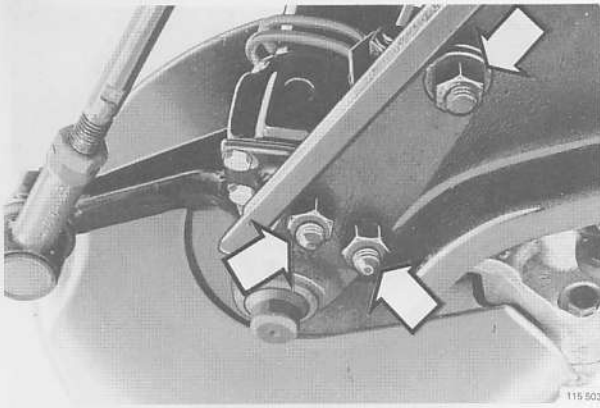

C10

**Tighten ball joint to control arm.**

Torque:  $115 \pm 15$  Nm =  $83 \pm 11$  ft.lbs.

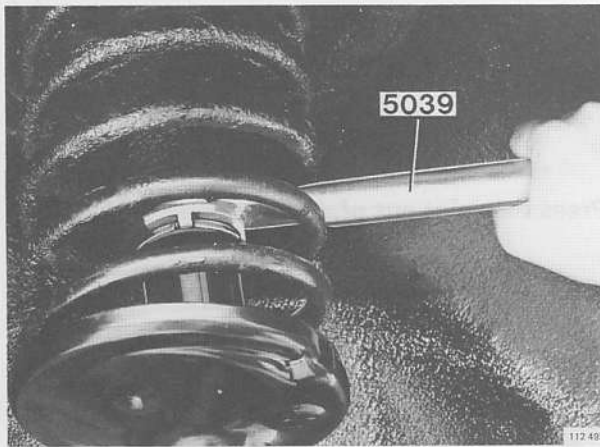

C11

**Tighten shock absorber retaining nut if previously loosened.**

See Step C3.



C12

**Install front wheels.**

Use marks previously made.

Torque:  $120 \pm 15$  Nm =  $87 \pm 9$  ft.lbs.

Remove stands.



## Replacing strut upper journal

Special tools: 5036, 5037, 5040, 5043, 5045

D1



### Support front end on stands.

Place stands under front jack attachments.  
Mark front wheels to avoid rebalancing.  
Remove front wheels.

D2



### Place jack under control arm, disconnect steering rod from steering arm.

Remove nut and detach rod with 5043.

D3

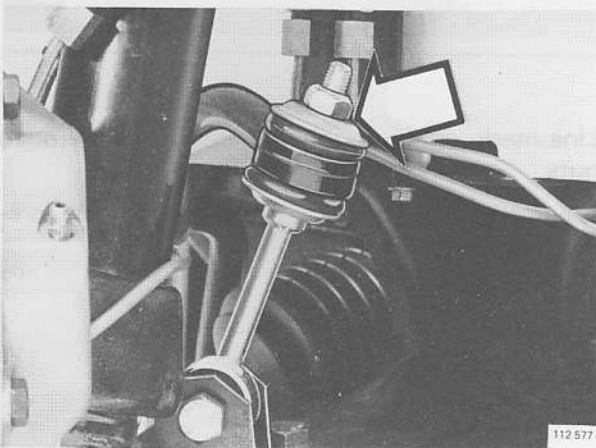

### Disconnect stabilizer bar from stabilizer link upper attachment.

D4

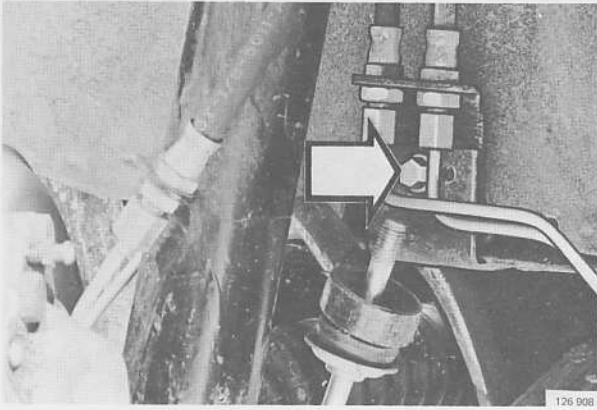

Remove brake pipe bracket bolt.

D5

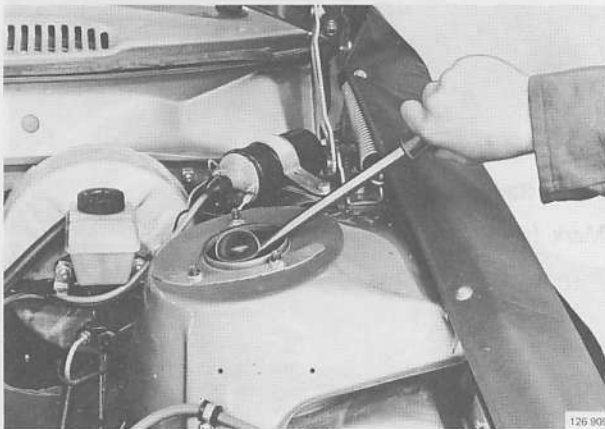

Remove protective cover over shock absorber nut.

Pry loose with screwdriver.

D6

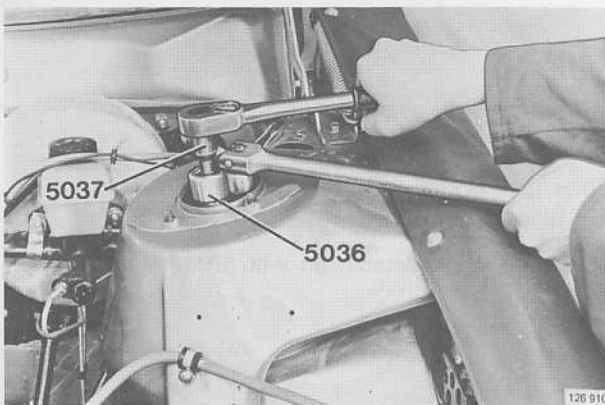

Loosen center nut.

Loosen nut several turns with 5036. Hold shock absorber plunger rod with 5037.

D7

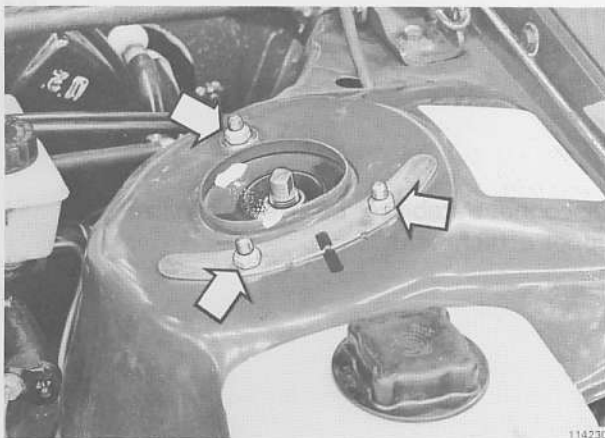

Line-mark upper journal position and remove nuts.

Line-mark over nut plate and wheel housing plate as illustrated.

D8

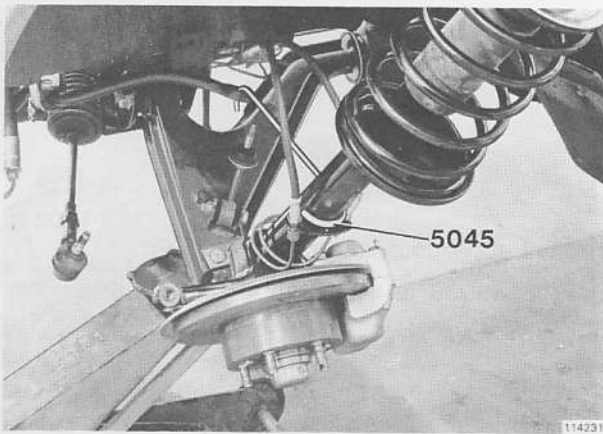

**Lower jack and guide out spring assembly.**

Hook spring assembly to shock absorber with retaining hook **5045**.

D9

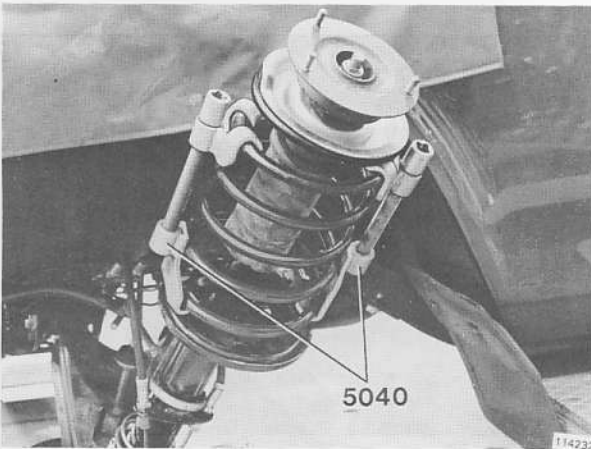

**Use tool 5040 to compress spring.**

Place the two hook-up tools opposite each other and with three spring coils free between the claws. Compress alternately.

D10

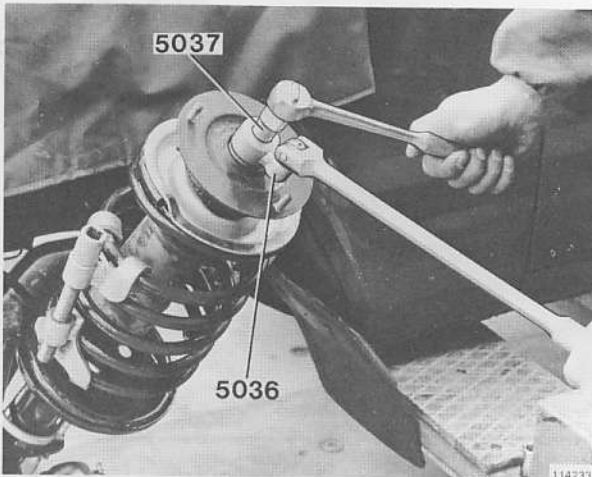

**Remove center nut, lift off upper journal.**

Use tool **5036** to remove nut. Hold shock absorber with **5037**.

D11

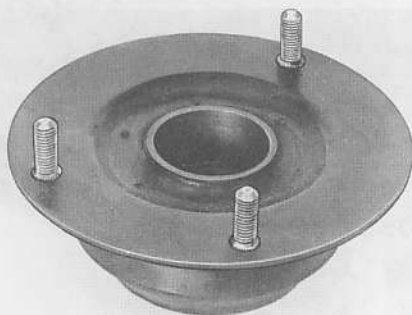

**Replace journal assembly.**

For vehicles with reinforcing rod (GT etc), one bolt is longer than the others.

D12

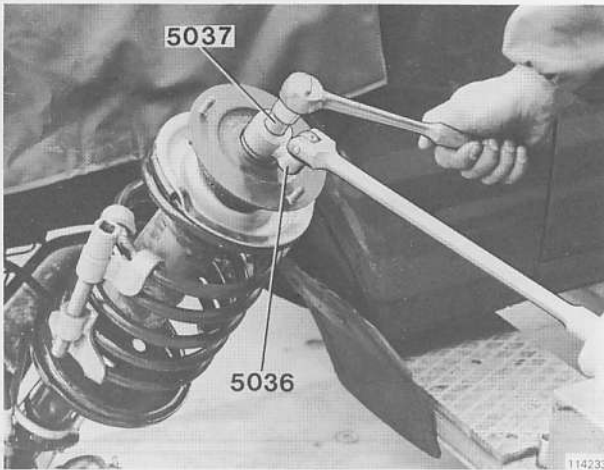

**Install upper journal, washer and nut.**  
Use tool **5036** to tighten nut. Hold with **5037**.

D13

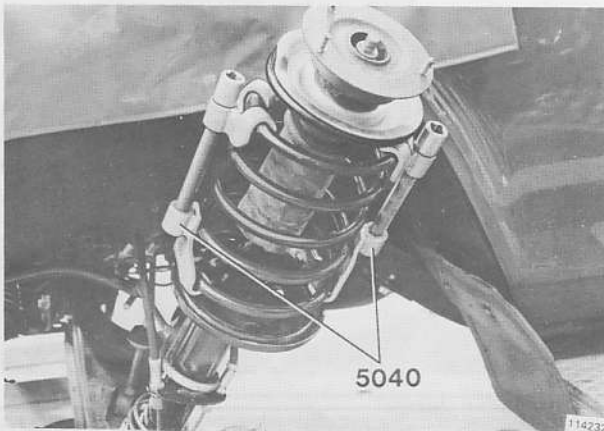

**Remove spring hook-up tool.**  
Loosen alternately. Make sure spring ends seat correctly in upper and lower seats.

D14

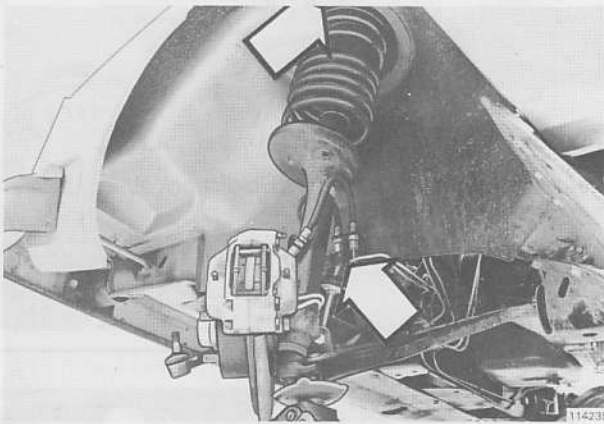

**Guide spring assembly into wheel housing.**  
Remove retaining hook and raise jack. Guide stabilizer link into position.

D15

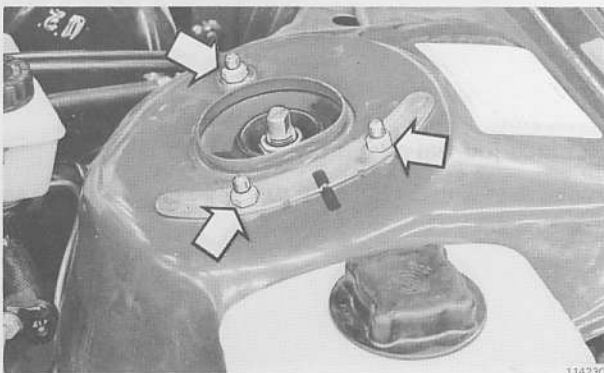

**Turn journal to correct position and tighten nuts.**  
Position journal according to linemark made previously.  
Torque:  $20 \pm 5 \text{ Nm} = 14 \pm 4 \text{ ft.lbs.}$

D16

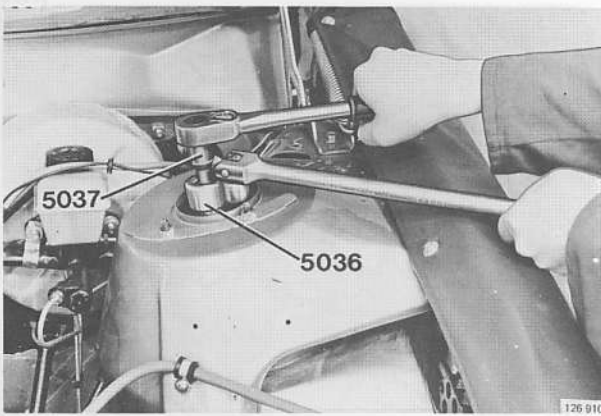

Tighten center nut and press protective cover into position.

Use tool 5036 to tighten and 5037 to hold.

D17

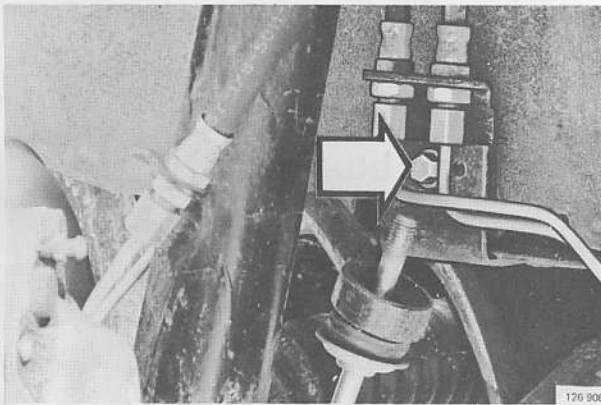

Tighten brake pipe bracket nut.

D18

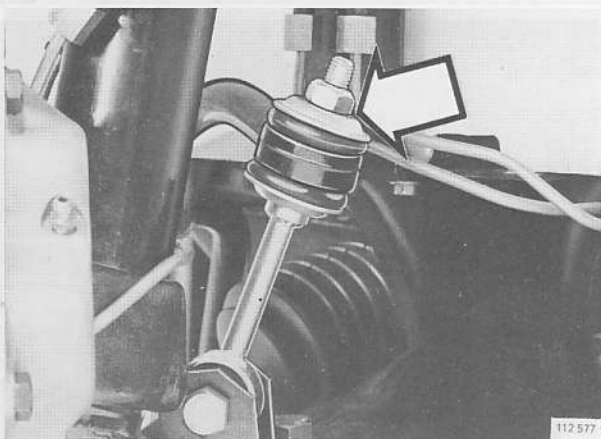

Tighten stabilizer link to stabilizer bar.

D19

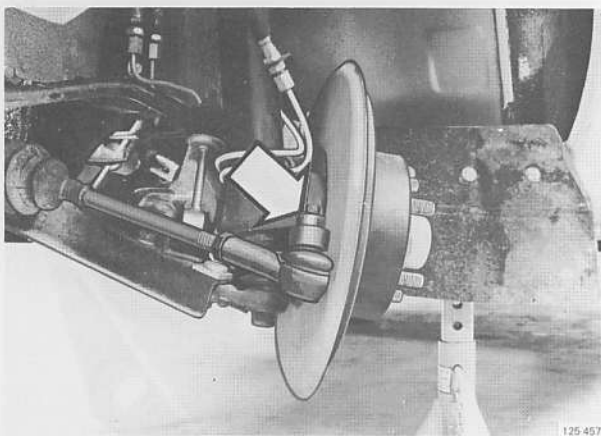

Tighten steering rod to steering arm.

Torque:  $60 \pm 10$  Nm =  $43 \pm 7$  ft.lbs.



**Install front wheels.**

Use marks previously made.

Torque:  $120 \pm 15$  Nm =  $87 \pm 9$  ft.lbs.

Remove stands.

**Replacing control arms and/or bushings**

Vehicle on rail lift

*Special tools: 1801, 5081, 5082, 5083, 5084, 5085, 5091*

E1

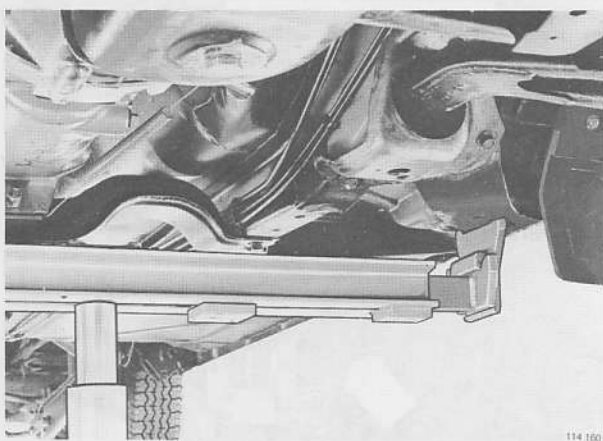

**Lift front end.**

Lift under jack attachments until wheels almost lift from rail.

E2

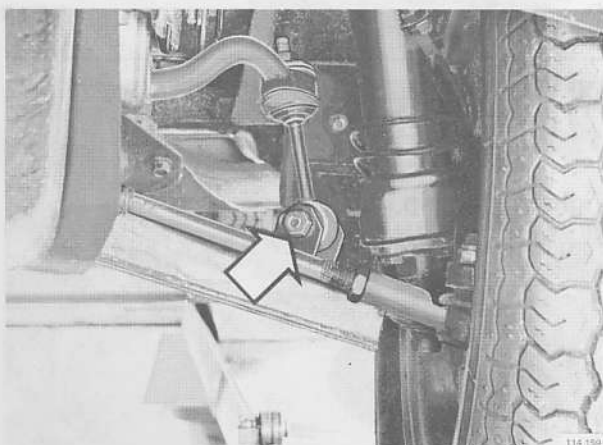

**Disconnect stabilizer link from control arm.**

E3

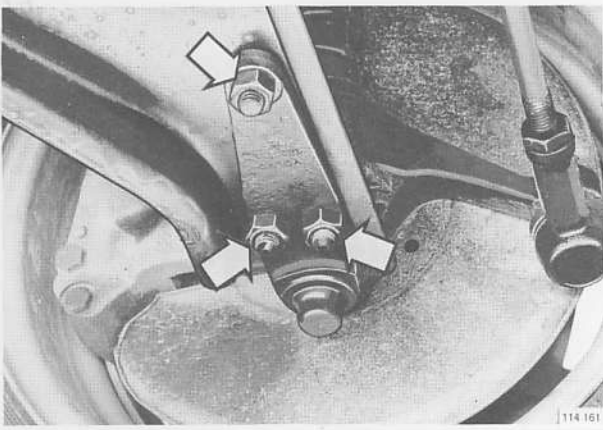

Disconnect ball joint from control arm.

E4

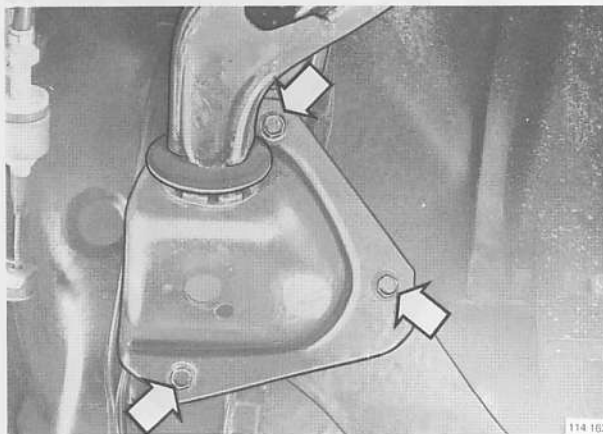

Disconnect rear bushing bracket from side member.

E5

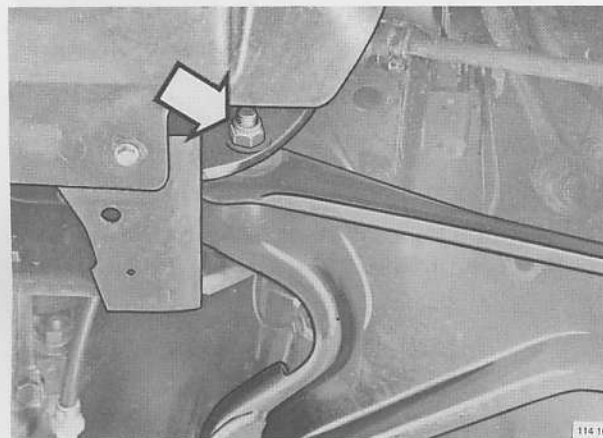

Remove control arm front retaining bolt.

E6

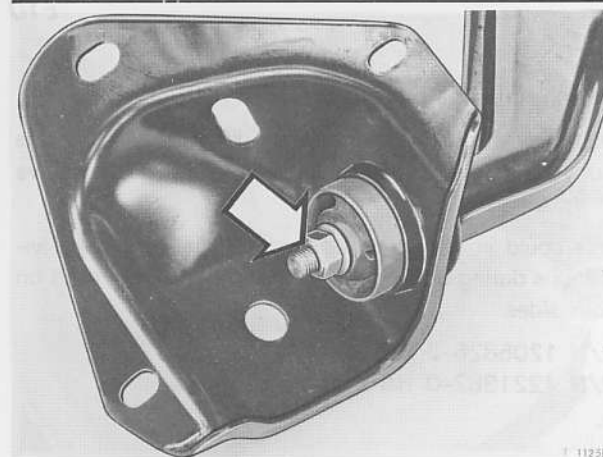

Remove control arm. Remove bracket.

E7

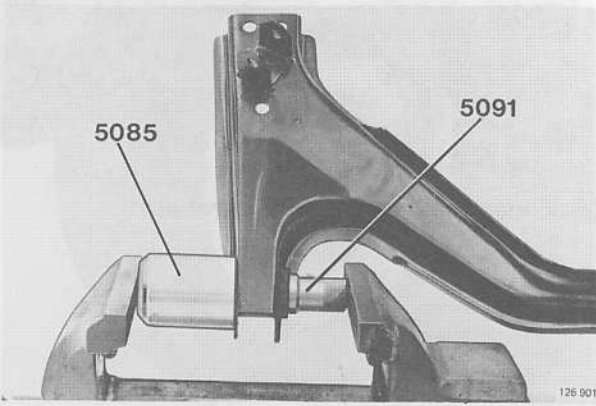

**Press out control arm bushing.**

Using vice, place tool **5085** over collar side of bushing. Use tool **5091** to press out bushing.

E8

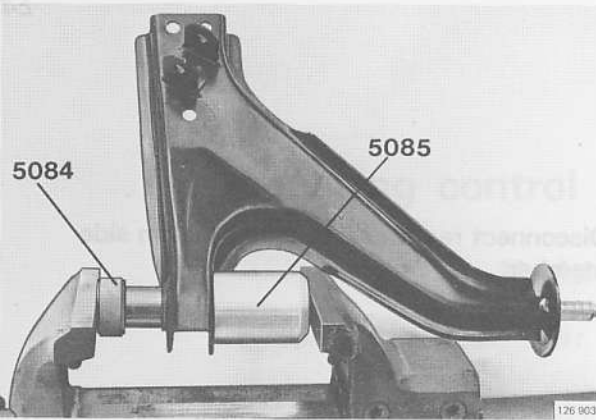

**Press in control arm bushing.**

Place tool **5084** against bushing collar side. Press with tool **5085** on reverse side.

E9

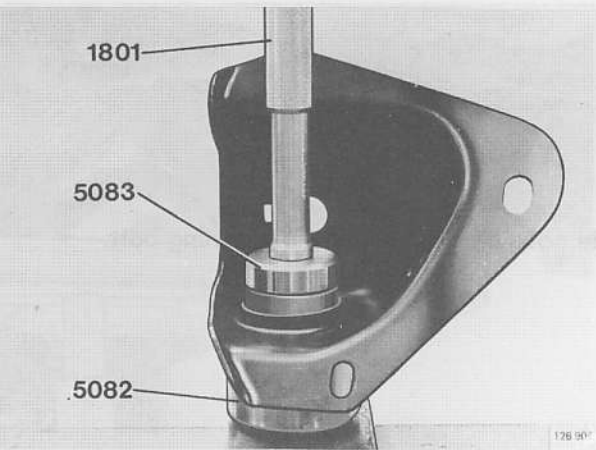

**Press out control arm bracket bushing.**

Place tool **5082** under bracket. Press out bushing with tool **5083** and handle **1801**.

E10



1205826-9  
soft



1221982-0  
hard 126 934

**Install new bushing in bracket.**

On earlier vehicles, bushings were different for right side (soft) and left side (hard) to make the car less sensitive to imbalance.

This could in certain cases result in steering wheel vibrations during braking. Hard bushings are now used on both sides.

P/N 1205826-9 Soft bushing  
P/N 1221982-0 Hard bushing



E11

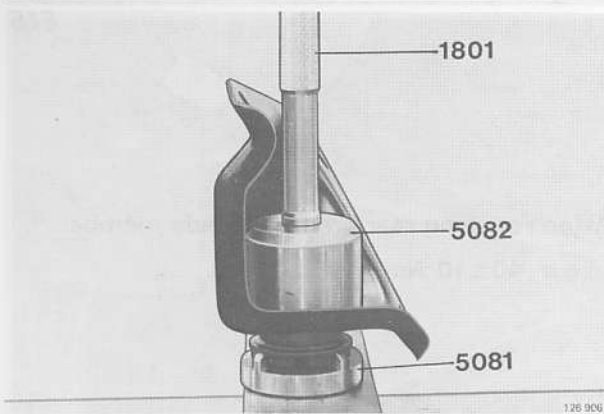

**Press in control arm bracket bushing.**

Place tool 5081 against bushing collar side. Press on bracket with tool 5082 and handle 1801.

E12

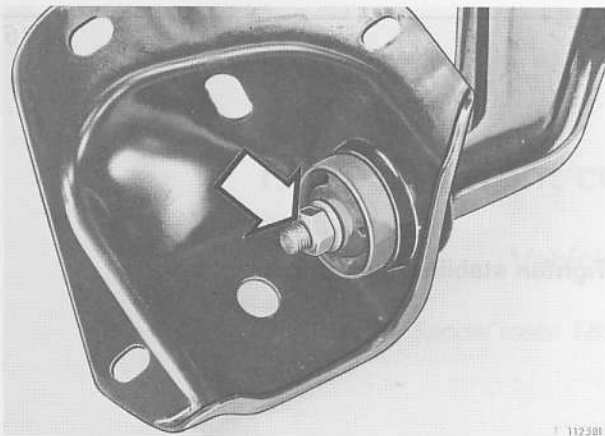

**Attach bracket to control arm.**

Install bracket, washer and nut. Do not tighten nut harder than washer can be turned by finger force.

E13

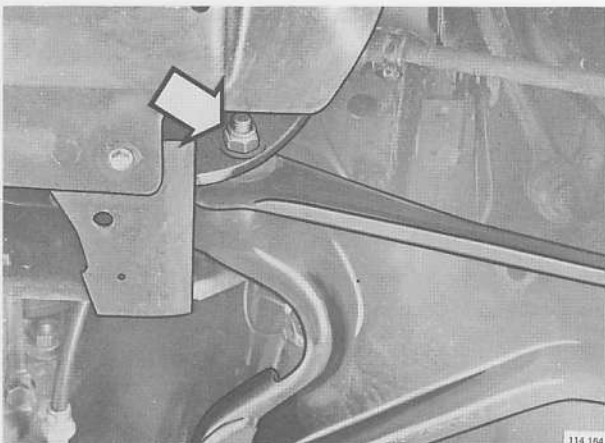

**Attach control arm.**

Install front retaining bolt without tightening nut.

E14

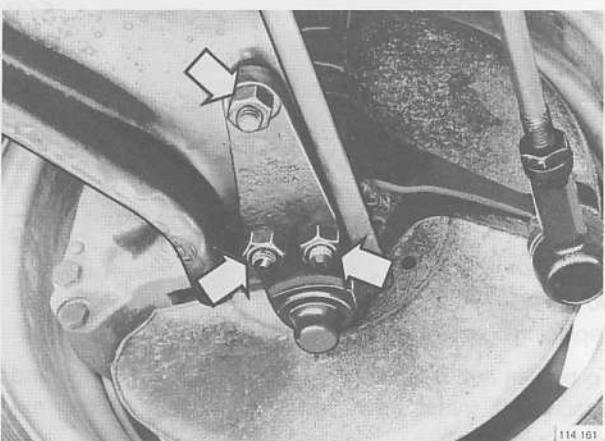

**Guide stabilizer link into position. Tighten ball joint to control arm.**

Torque:  $115 \pm 15$  Nm =  $83 \pm 11$  ft.lbs.

E15

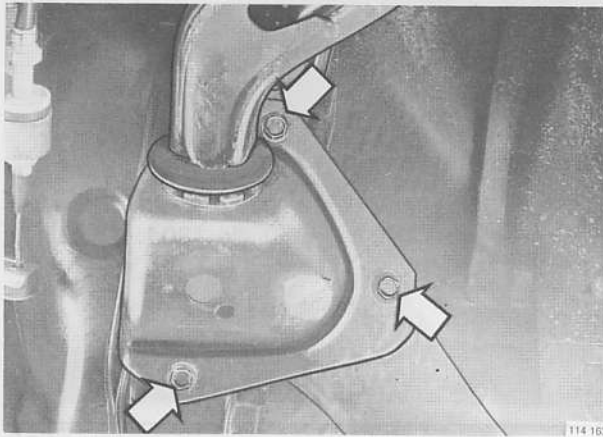

**Attach bushing rear bracket to side member.**

Torque:  $40 \pm 10$  Nm =  $29 \pm 7$  ft.lbs.

E16

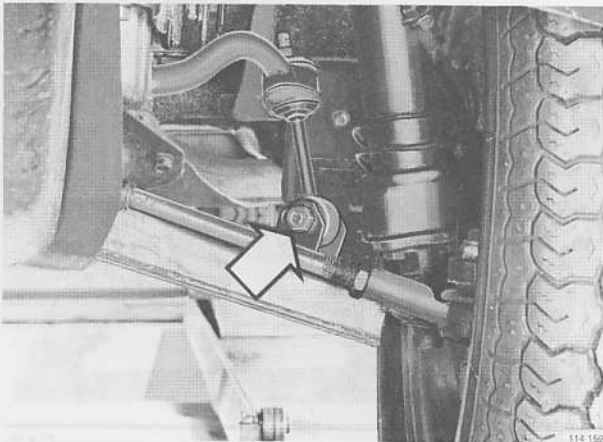

**Tighten stabilizer link to control arm.**

E17

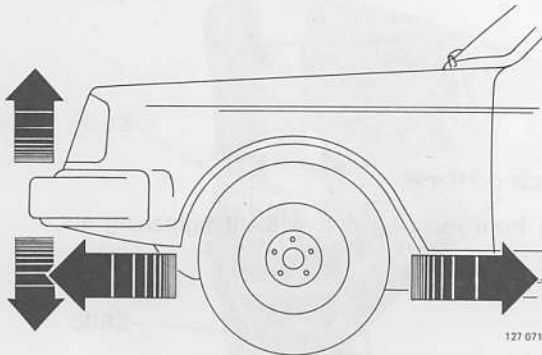

**Lower front end.**

Roll car back and forth while bouncing it up and down several times to let control arms take up normal position.

E18

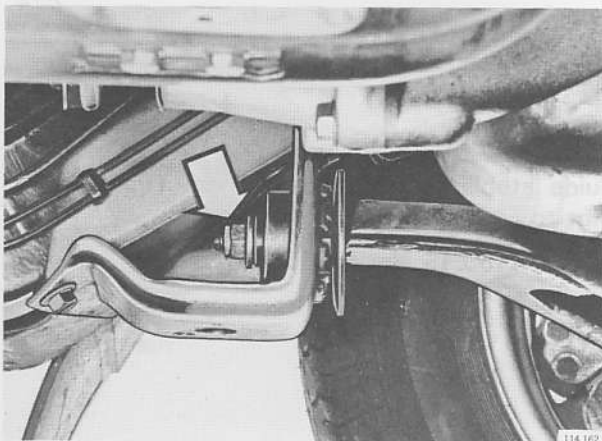

**Tighten bushing rear nut.**

Torque:  $55 \pm 5$  Nm =  $40 \pm 4$  ft.lbs.

E19

Note:

Replacing right side bushings on vehicles with B21 engine:

To tighten nut, disconnect exhaust pipe from flange and attachment. Install new gasket when reconnecting exhaust pipe.

E20

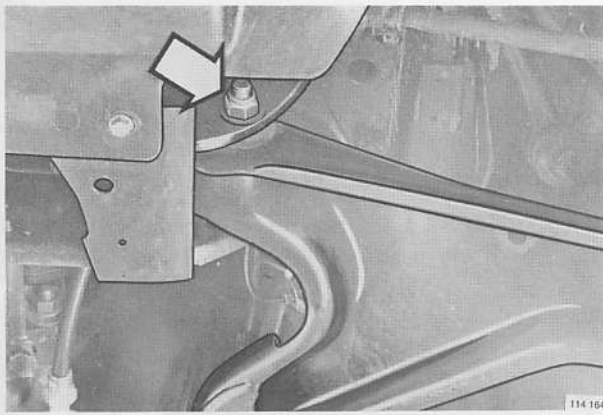

**Tighten front bushing bolt.**

Torque:  $75 \pm 20$  Nm =  $54 \pm 15$  ft.lbs.

## Replacing front control arm rear bushing

Vehicle on rail lift

Special tools: 1801, 5081, 5082, 5083

F1

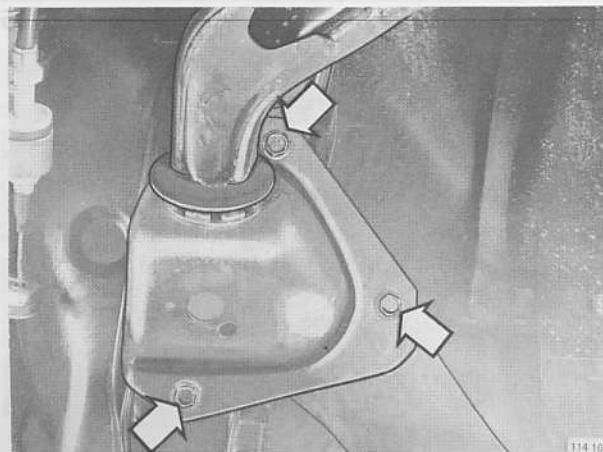

**Disconnect rear bushing bracket from side member.**

F2

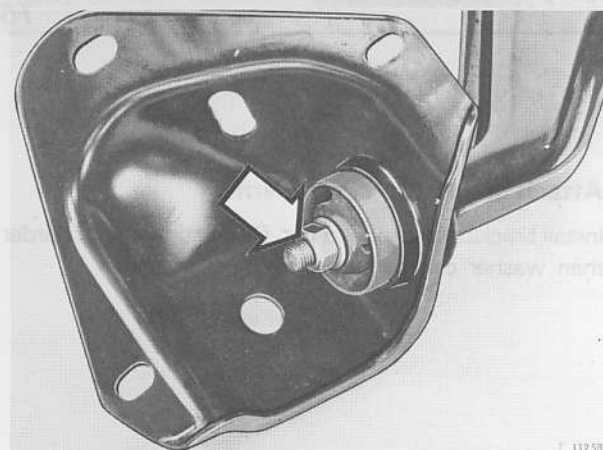

**Remove bracket from control arm.**

Remove nut and bracket from control arm.

F3

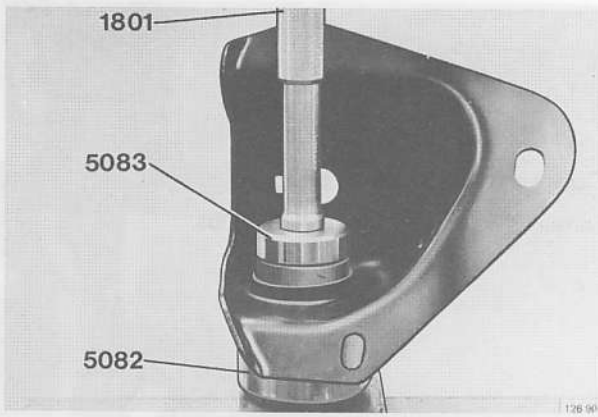

**Press out control arm bracket bushing.**

Place tool **5082** under bracket. Press out bushing with tool **5083** and handle **1801**.

F4



1205826-9  
soft

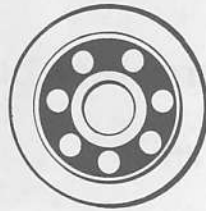

1221982-0  
hard 126 934

**Install new bushing in bracket.**

On earlier vehicles, bushings were different for right side (soft) and left side (hard) to make the car less sensitive to imbalance.

This could in certain cases result in steering wheel vibrations during braking. Hard bushings are now used on both sides.

P/N 1205826-9 Soft bushing

P/N 1221982-0 Hard bushing

F5

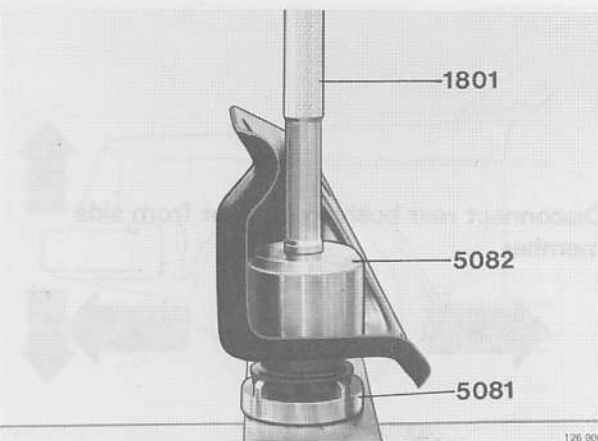

**Press in control arm bracket bushing.**

Place tool **5081** against bushing collar side. Press on bracket with tool **5082** and handle **1801**.

F6

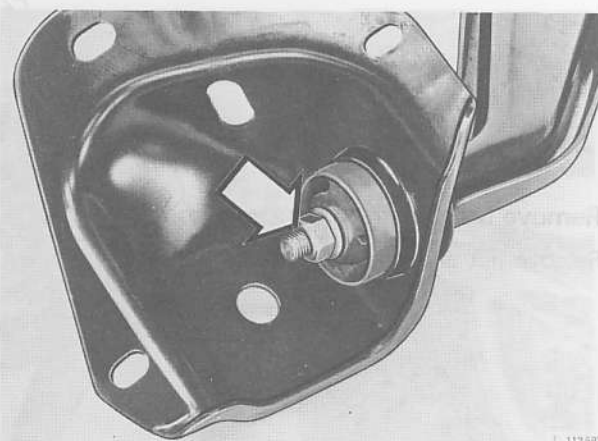

**Attach bracket to control arm.**

Install bracket, washer and nut. Do not tighten nut harder than washer can be turned by finger force.

F7

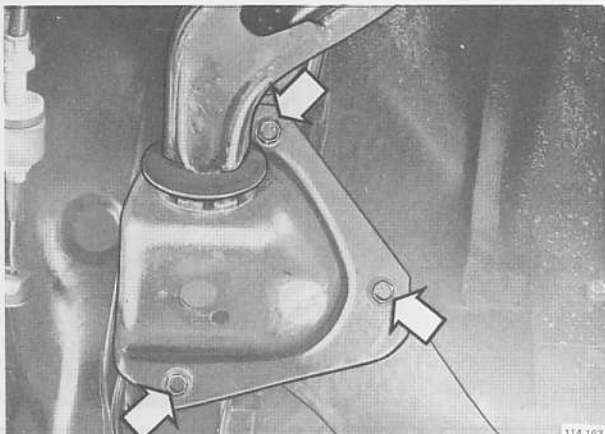

Attach bushing rear bracket to side member.

Torque:  $40 \pm 10$  Nm =  $29 \pm 7$  ft.lbs.

F8

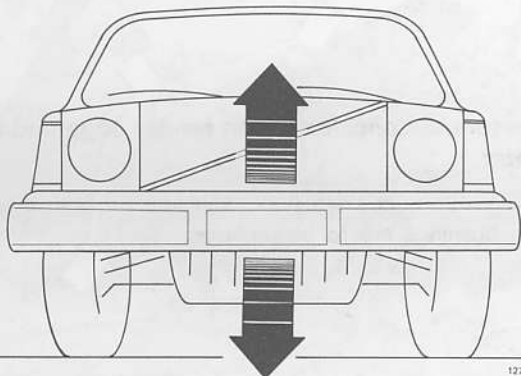

Bounce front end.

Bounce front end up and down several times to let control arms take up normal position.

F9

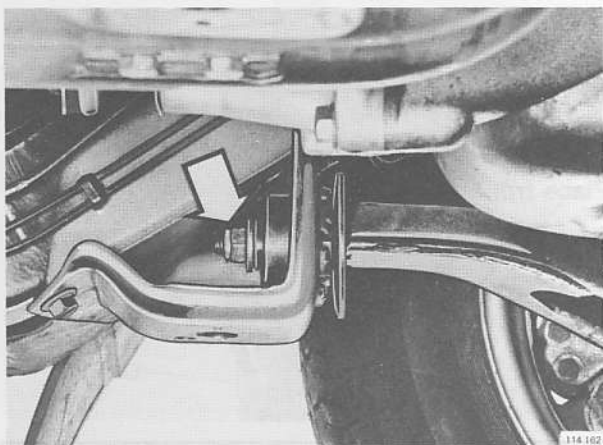

Tighten bushing rear nut.

Torque:  $55 \pm 5$  Nm =  $40 \pm 4$  ft.lbs.

F10

Note:

Replacing right side bushings on vehicles with B21 engine:

To tighten nut, disconnect exhaust pipe from flange and attachment. Install new gasket when reconnecting exhaust pipe.

## Replacing control arm rear bushing

Vehicle on floor

Special tools: 1801, 5081, 5082, 5083

G1

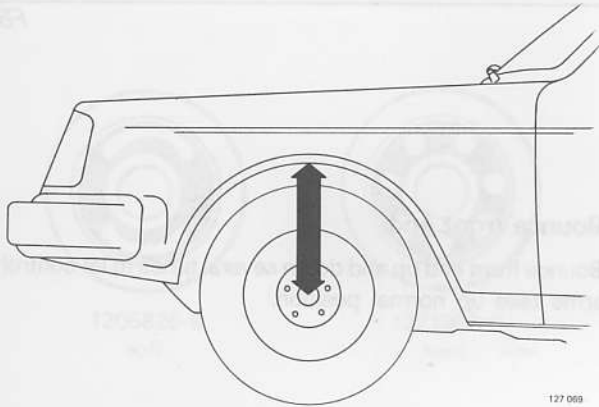

**Measure distance between fender edge and hub center.**

Before lifting car from floor. Measure on both sides if both bushings are to be replaced.

G2

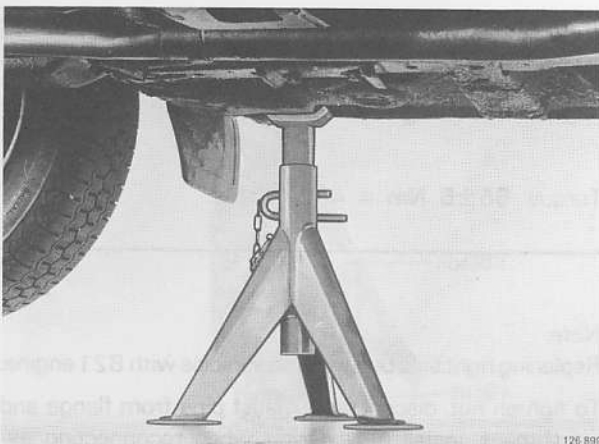

**Place front end on stands.**

Place stands under front jack attachments.

G3

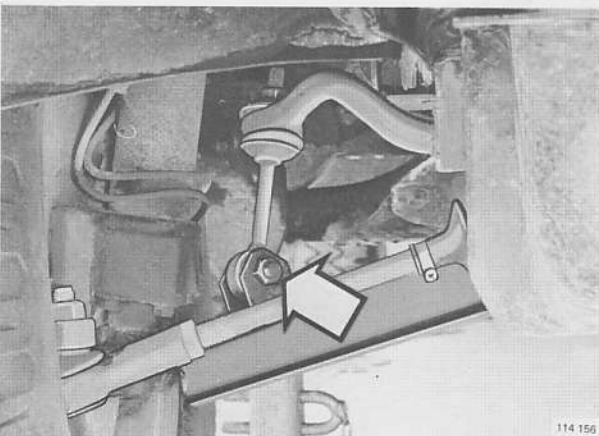

**Disconnect stabilizer links from control arms.**

Disconnect on both sides even if only one bushing is replaced. The reason is to let the control arms take up correct position when tightening.

G4

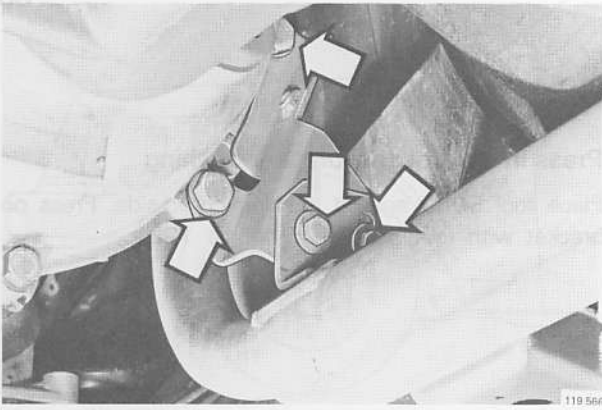
**Note:**

When replacing right side bushings on vehicles with B21 engines, disconnect exhaust pipe from flange and front attachment.

**NOTE:**

Left side on wheel will not produce steering and suspension noise.

G5

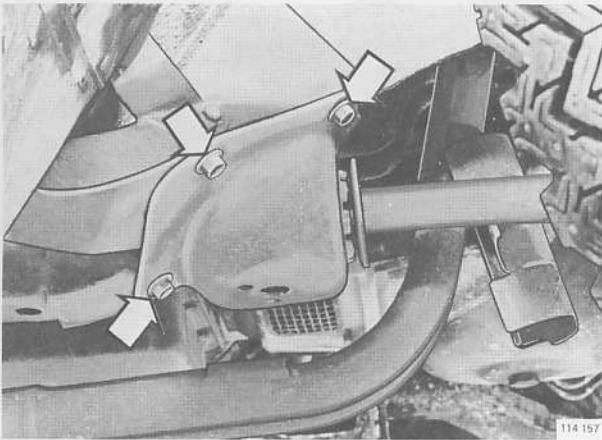

Disconnect bracket from side member and control arm.

G6

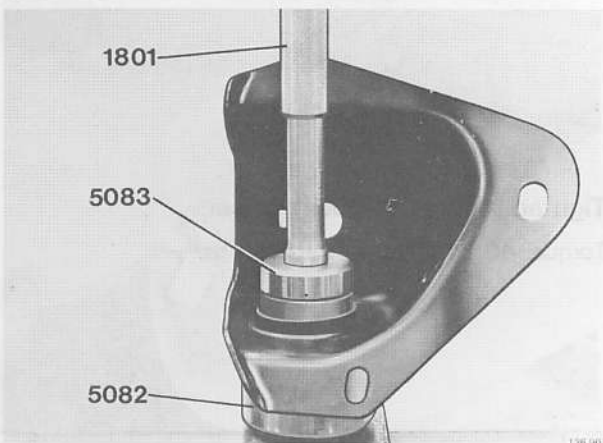

**Press out control arm bracket bushing.**

Place tool **5082** under bracket. Press out bushing with tool **5083** and handle **1801**.

G7



1205826-9  
soft

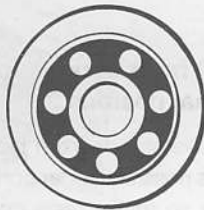

1221982-0  
hard 126 934

**Install new bushing in bracket.**

On earlier vehicles, bushings were different for right side (soft) and left side (hard) to make the car less sensitive to imbalance.

This could in certain cases result in steering wheel vibrations during braking. Hard bushings are now used on both sides.

P/N 1205826-9 Soft bushing

P/N 1221982-0 Hard bushing

G8

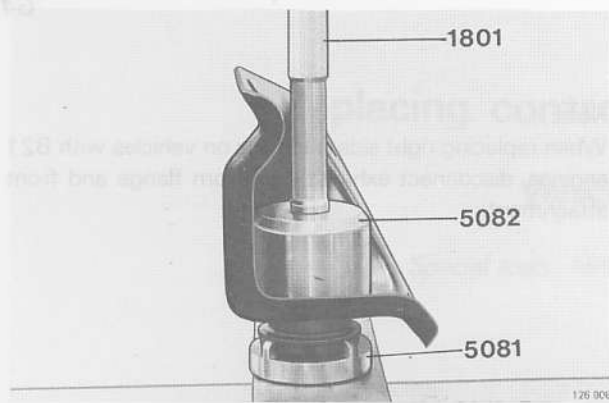

**Press in control arm bracket bushing.**

Place tool **5081** against bushing collar side. Press on bracket with tool **5082** and handle **1801**.

G9

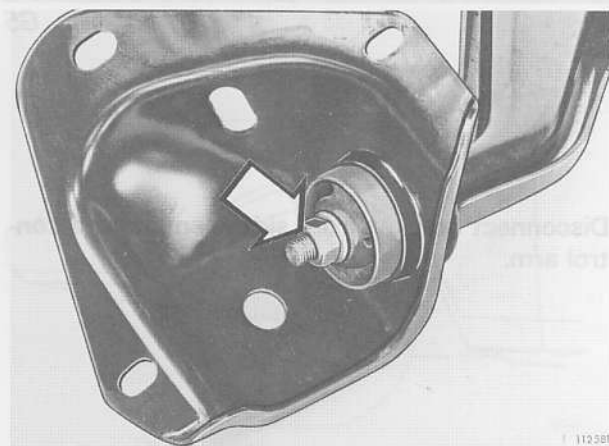

**Attach bracket to control arm.**

Install bracket, washer and nut. Do not tighten nut harder than washer can be turned by finger force.

G10

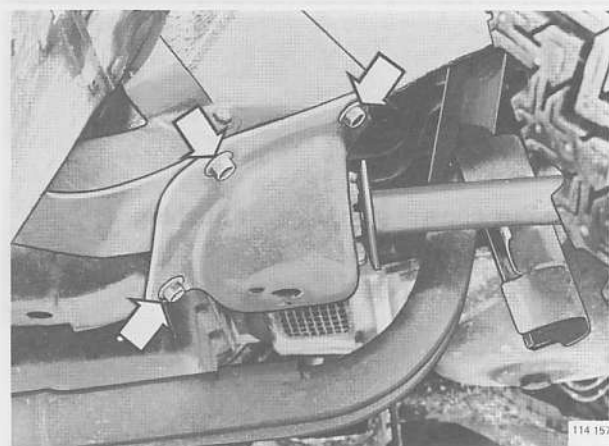

**Tighten bracket to side member.**

Torque:  $40 \pm 10 \text{ Nm} = 29 \pm 7 \text{ ft.lbs.}$

G11



**Load front springs to let control arms take up normal position.**

Remove stands from jack attachments. Place jack as far out as possible under control arm with new bushing. Lower car so that it rests on stand and wheel on other side.



G12

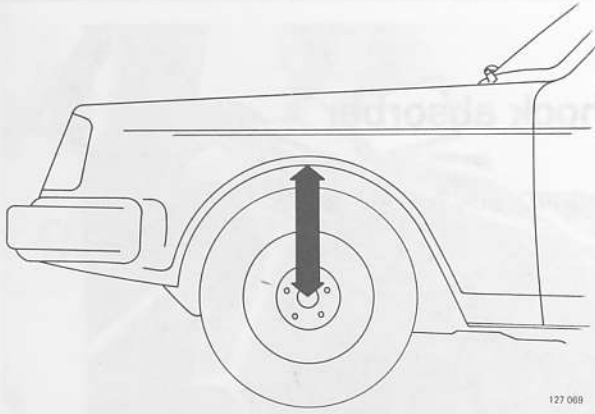

**Measure distance between fender edge and hub center.**

Bounce car several times and measure distance. It should be same as in Step G1.

**NOTE:**

One side on wheel, one side on stand will not introduce inaccuracy and is necessary to be able to reach the nut in next step.

127 009

G13

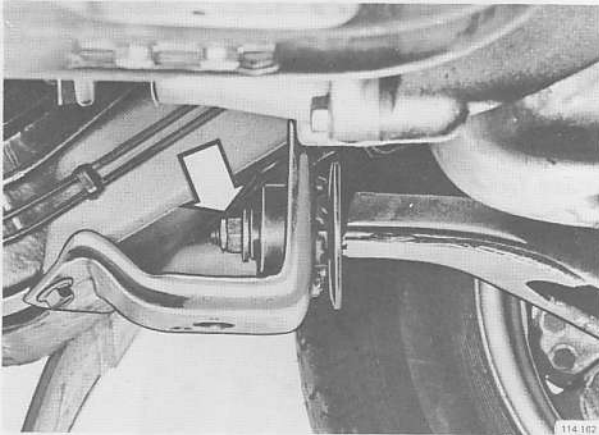

**Tighten rear bushing.**

Torque:  $55 \pm 5$  Nm =  $40 \pm 4$  ft.lbs.

Raise car again and put it on two stands.

114 102

G14

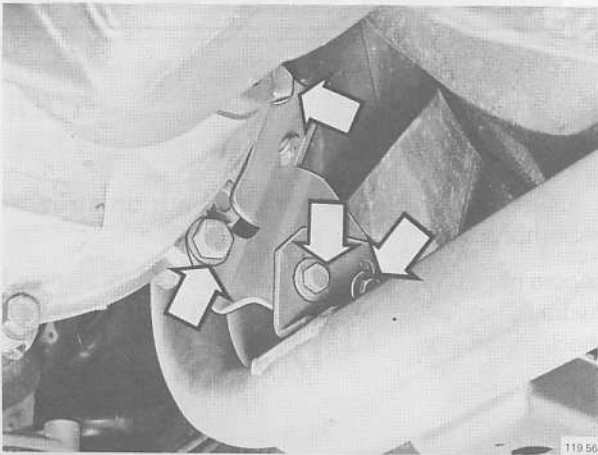

**NOTE:**

When replacing right side bushings on vehicles with B21 engine, install new flange gasket. Attach exhaust pipe to flange and front attachment.

119 504

G15

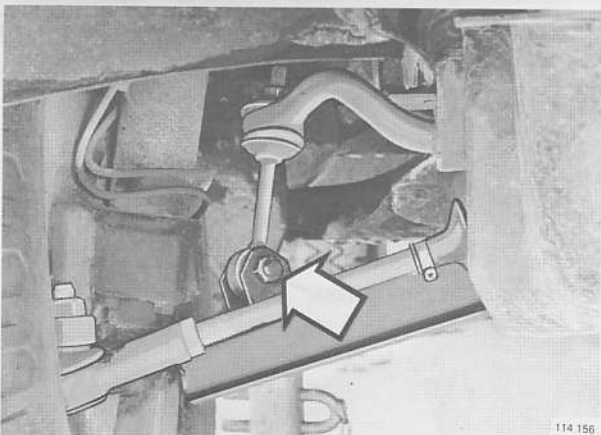

**Tighten stabilizer links on both sides.**

114 156

## Replacing front shock absorber

Special tools: 5036, 5037, 5039, 5040, 5043, 5045, 5173

H1



### Raise front end.

Jack up front end. Place stands under front jack attachments.

Mark wheel location to avoid rebalancing. Remove wheels.

H2

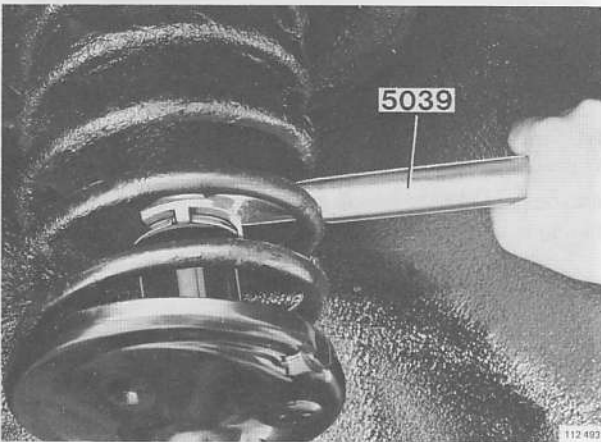

### Loosen shock absorber retaining nut on strut assembly.

Loosen nut a couple of turns. Use tool **5039** for standard (hydraulic) shock absorbers and **5173** for gas-pressure shock absorbers.

H3



### Disconnect steering rod from steering arm.

Place jack under control arm. Remove nut. Use tool **5043** to disconnect steering rod.

H4

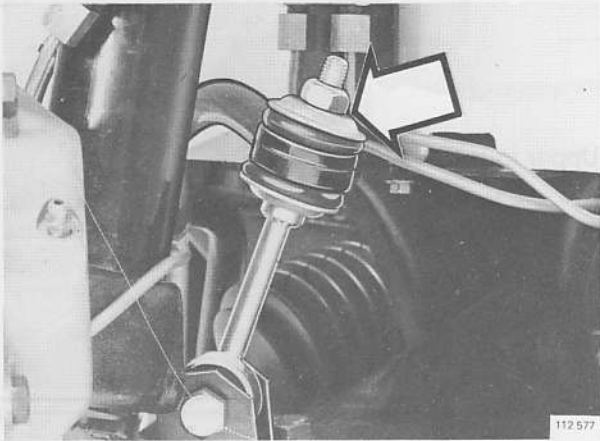

Disconnect stabilizer from upper link attachment.

H5

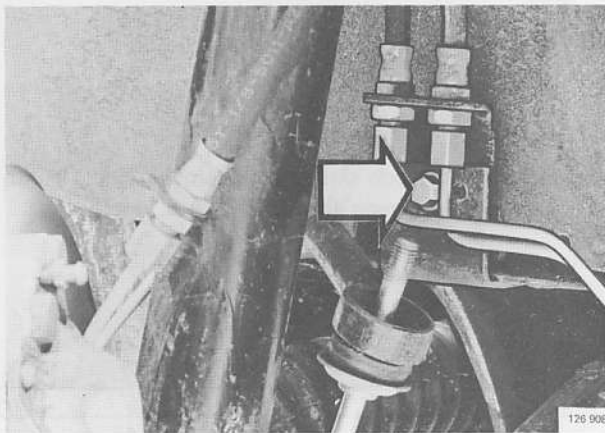

Remove bolt for brake pipe bracket.

H6

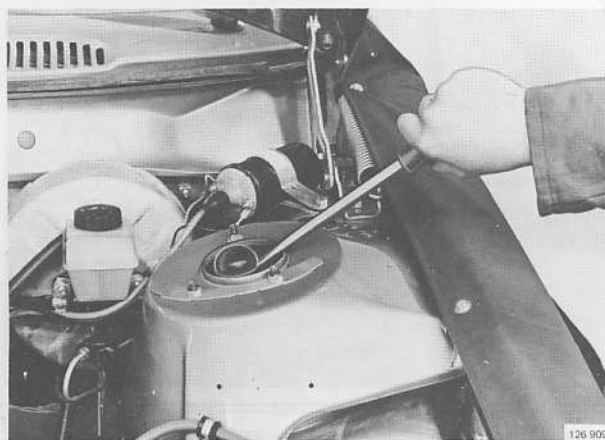

Remove protective cover over center nut.  
Pry loose with screwdriver.

H7

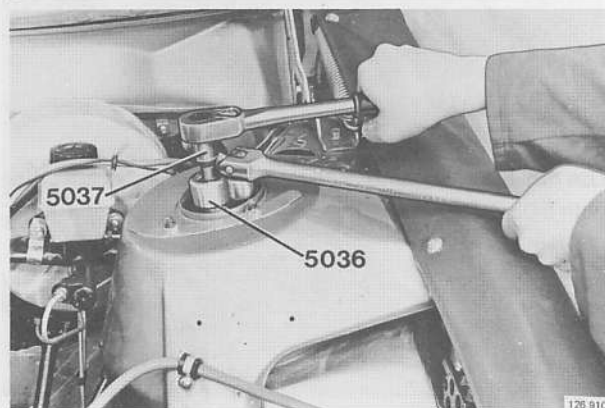

Loosen shock absorber retaining nut.  
Loosen nut several turns. Use tool **5036** and hold shock absorber plunger rod with **5037**.

H8

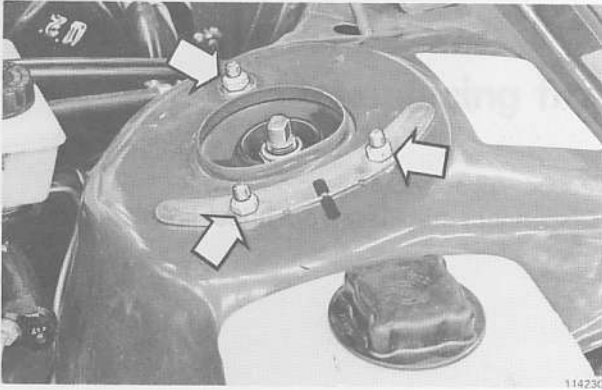

**Upper journal.**

Line-mark over nut plate and wheel housing plate. Remove nuts.

H9

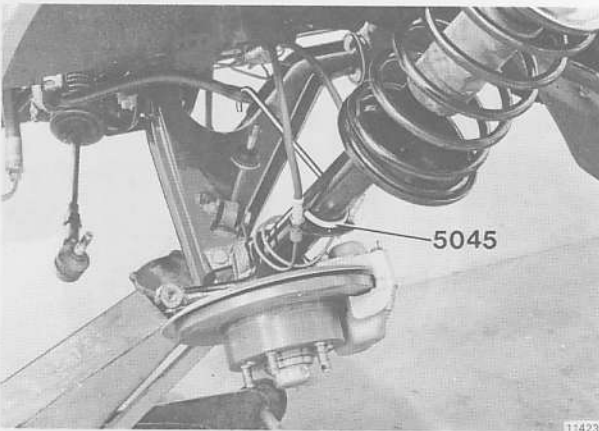

**Strut.**

Lower jack and guide out strut assembly. Hook it into stabilizer with retaining tool **5045**.

H10

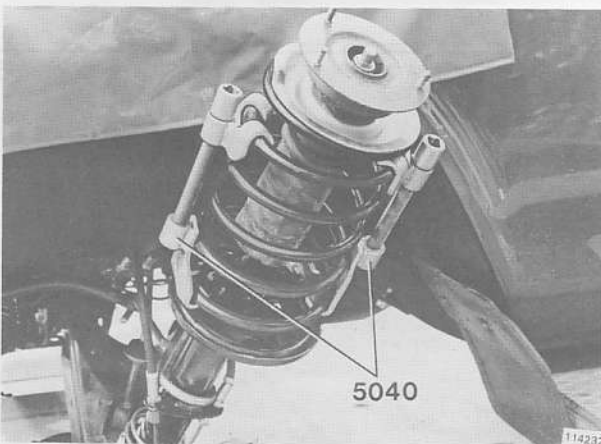

**Spring.**

Attach spring hook-up tools opposite each other. Three spring coils free between claws. Compress alternately.

H11

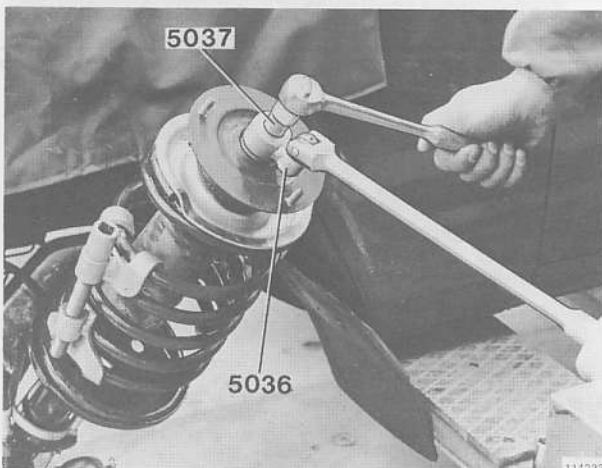

**Upper journal.**

Use tool **5036** to remove center nut. Hold shock absorber with **5037**. Remove upper journal, spring seat and rubber bumper.

H12

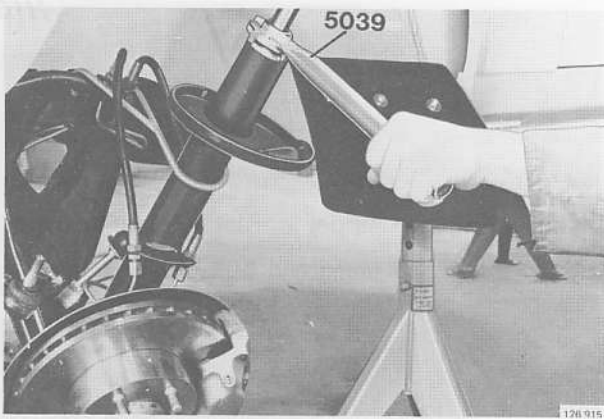

**Remove shock absorber retaining nut.**

Use tool **5039** for standard (hydraulic) shock absorber and **5173** for gas-pressure shock absorber.

H13

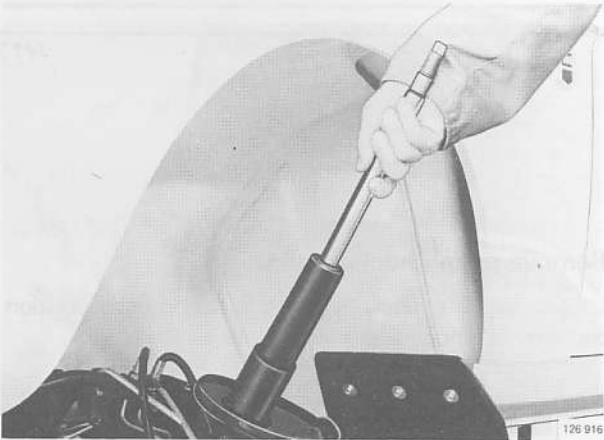

**Pull up shock absorber.**

H14

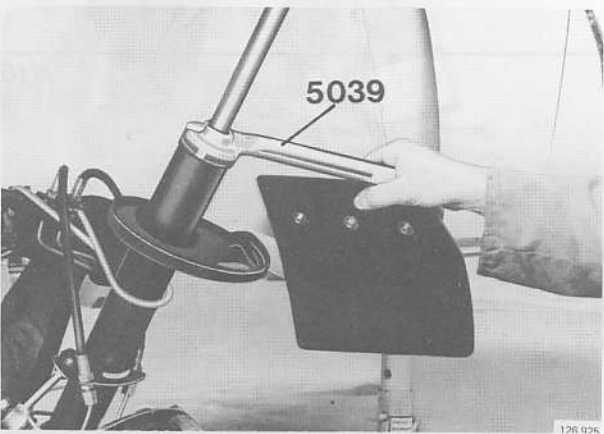

**Insert new shock absorber.**

Tighten nut as much as possible without turning strut. Use tool **5039** for standard (hydraulic) shock absorber and **5173** for gas-pressure shock absorber.

H15

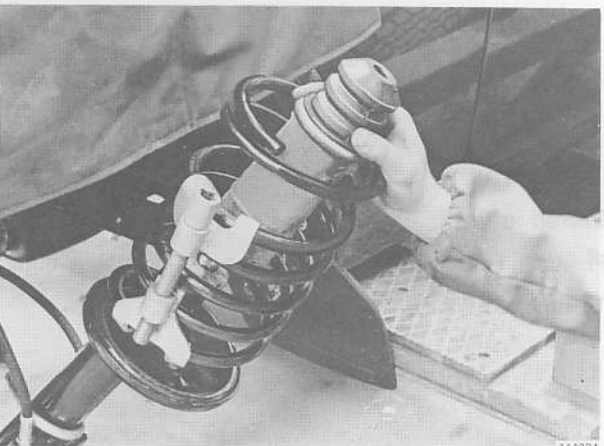

**Install spring, rubber damper and shock absorber protection.**

Turn spring so that spring hook-up tool claws face up.

H16

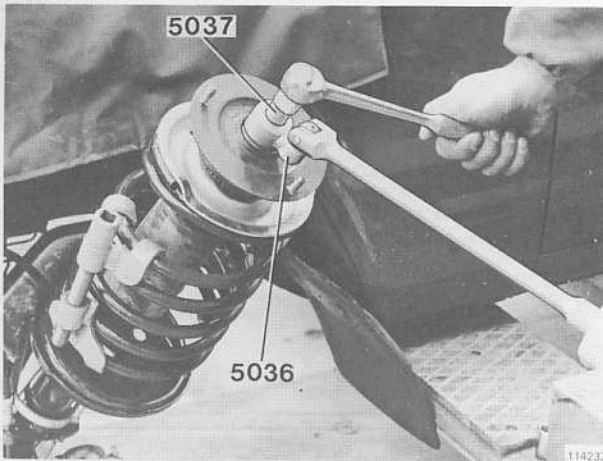

Install spring seat, upper journal, washer and nut.  
Use tool 5036 to tighten and 5037 to hold.

H17

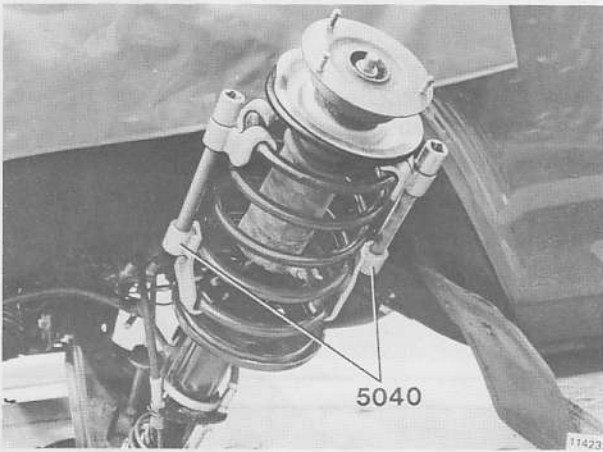

Remove spring hook-up tool.  
Loosen tool alternately. Make sure spring ends position correctly in upper and lower seats.

H18

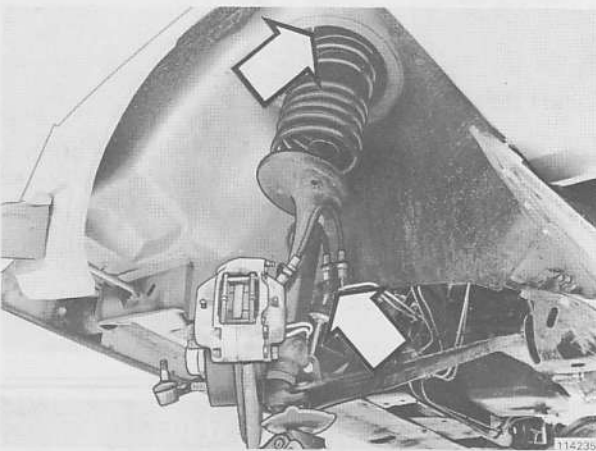

Guide strut assembly into wheel housing.  
Remove retaining hook. Raise jack. Make sure stabilizer link guides into position.

H19

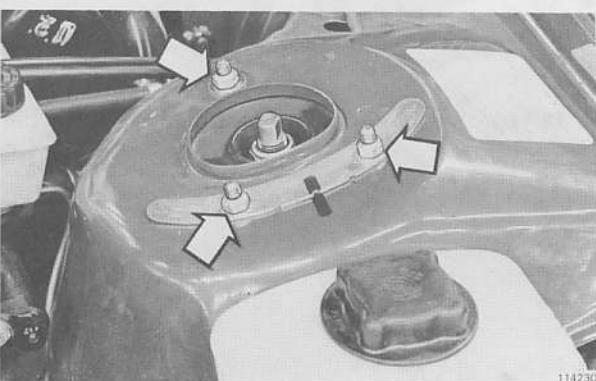

Install journal.  
Position journal according to line-marks. Tighten nuts.  
Torque:  $20 \pm 5 \text{ Nm} = 14 \pm 4 \text{ ft.lbs.}$

H20

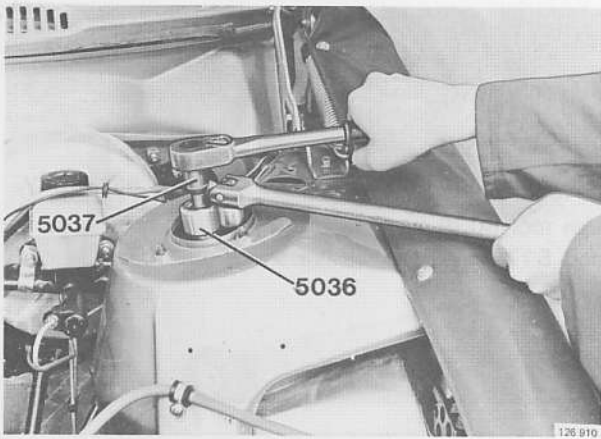

**Tighten center nut.**

Use tool **5036** to tighten and **5037** to hold. Press protective cover into position.

H21

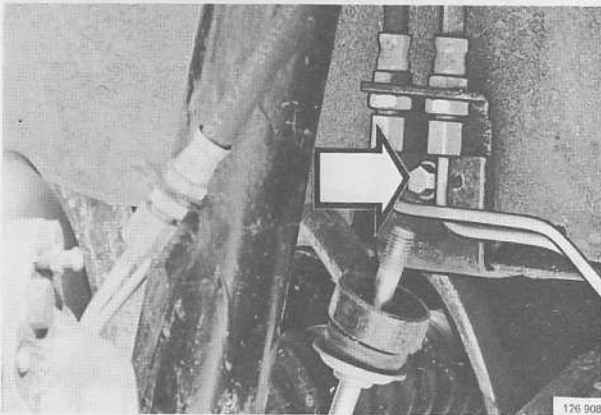

**Tighten brake pipe bracket.**

H22

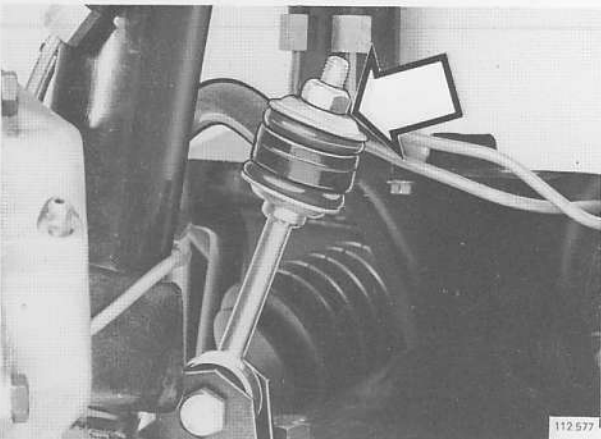

**Tighten stabilizer link to bar.**

H23

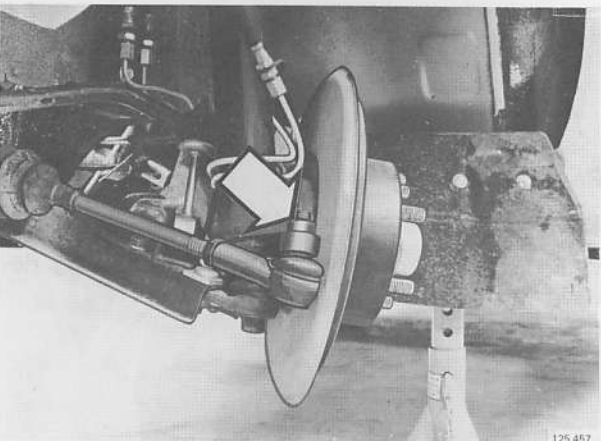

**Tighten steering rod to steering arm.**

Torque:  $60 \pm 10 \text{ Nm} = 43 \pm 7 \text{ ft.lbs.}$

H24

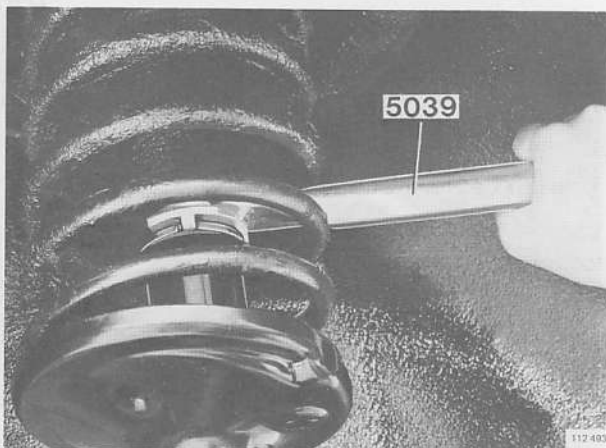

**Tighten shock absorber nut on strut assembly.**

Use tool **5039** for standard (hydraulic) shock absorber and **5173** for gas-pressure shock absorber.

H25



**Install front wheel.**

Use markings, previously made.  
Torque:  $120 \pm 20 \text{ Nm} = 87 \pm 9 \text{ ft.lbs.}$

## Replacing front coil spring

*Special tools: 5036, 5037, 5040, 5041, 5043, 5045*

I 1



**Raise front end.**

Jack up, place stands under front jack attachments.  
Mark location of front wheels to avoid re-balancing. Remove wheels.



12

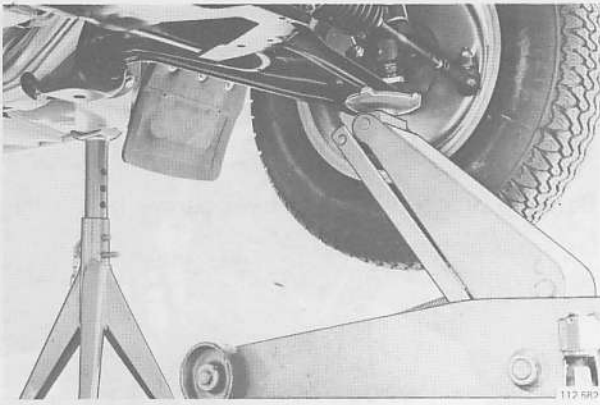

Place jack under control arm as support.

13

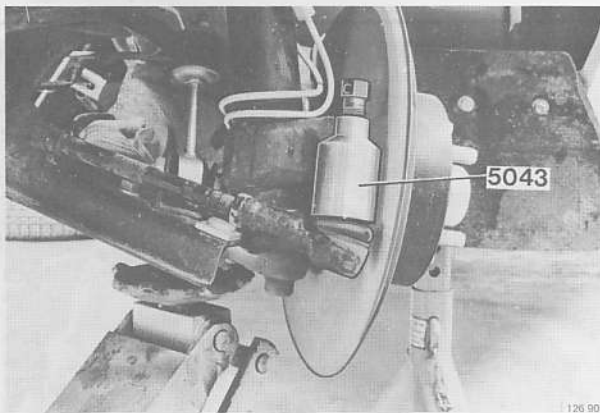

Disconnect steering rod from steering arm.  
Use tool 5043.

14

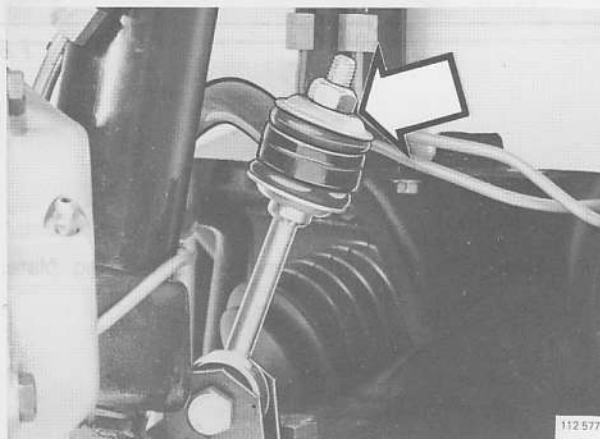

Disconnect stabilizer from link.

15

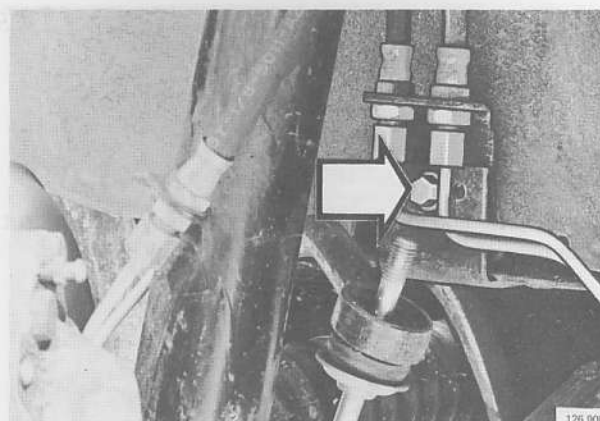

Remove bolt for brake pipe bracket.

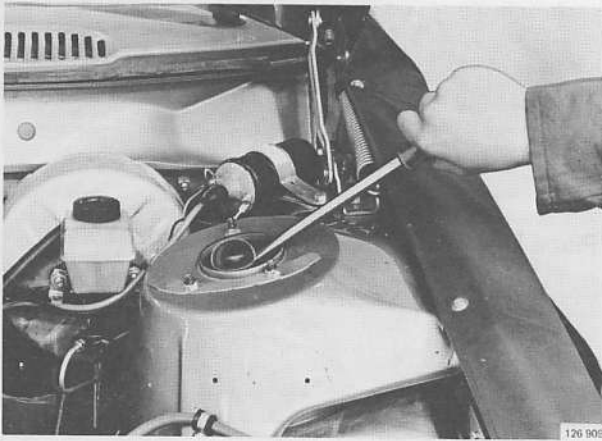

**Remove protective cover over center nut.**  
Pry loose with screwdriver.

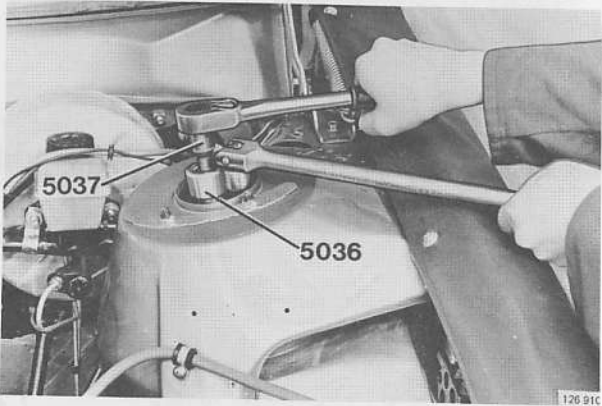

**Loosen center nut.**  
Loosen several turns. Use tool **5036** and hold shock absorber plunger with **5037**.

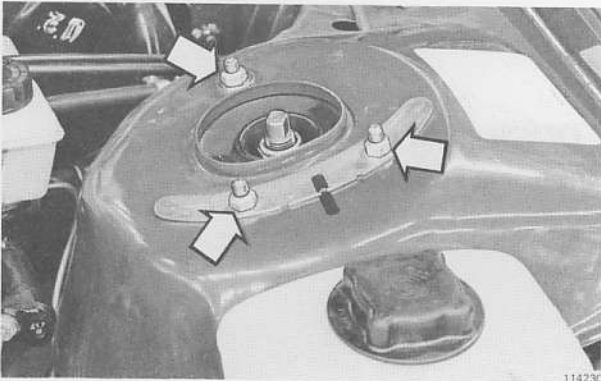

**Upper journal.**  
Line-mark across nut plate and wheel housing plate.  
Remove nuts.

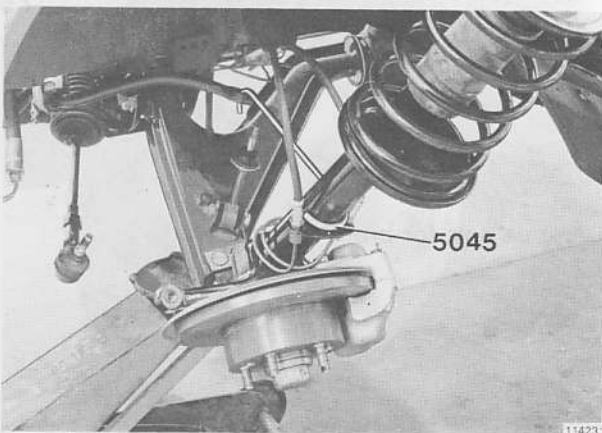

**Disconnect strut.**  
Lower jack and guide out strut assembly. Hook strut assembly to stabilizer with retaining hook **5045**.

I 10

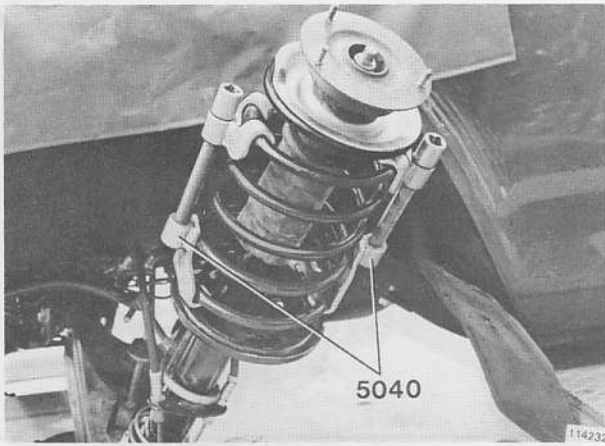

**Spring:**

Attach spring hook-up tools opposite each other. Three spring coils free between claws. Compress alternately.

I 11

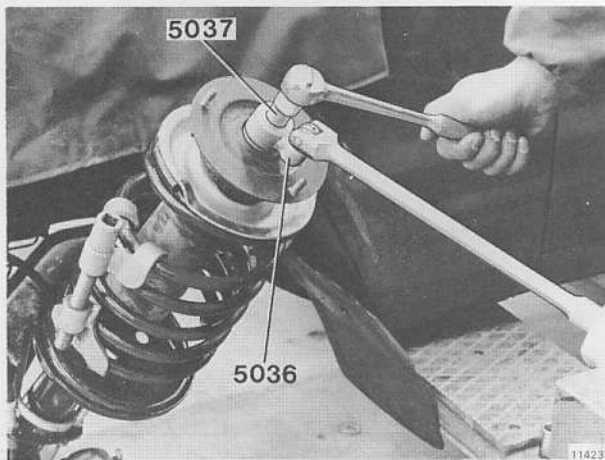

**Upper Journal:**

Use tool 5036 to remove center nut. Hold shock absorber with 5037. Remove upper journal, spring seat and rubber bumper.

I 12

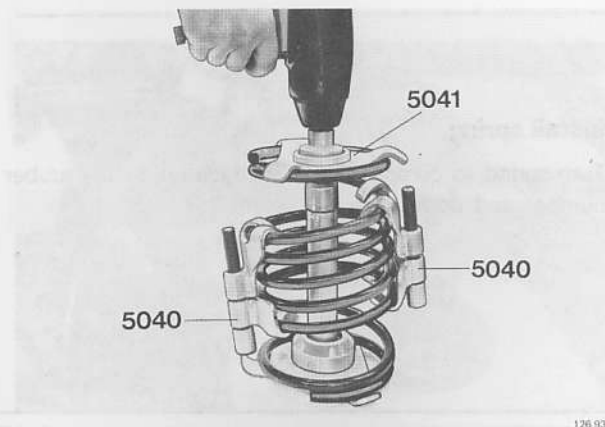

**Compress spring.**

Use spring compressor 5041 and impact gun.

I 13

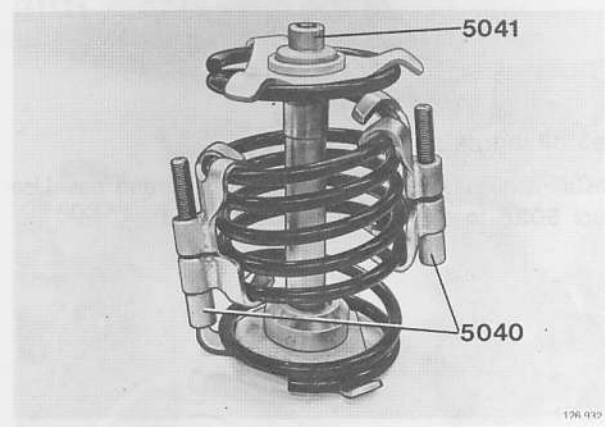

**Free spring.**

First remove spring hook-up tool 5040, then spring compressor 5041.

I 14

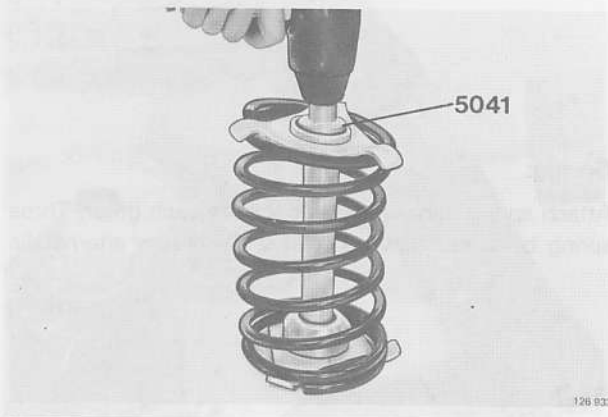

**Compress new spring.**

Use spring compressor **5041** and impact gun.

I 15

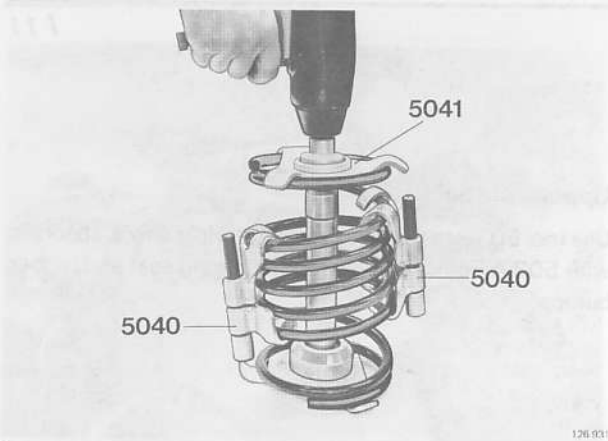

**Install spring hook-up tool.**

Place spring hook-up tools **5040** opposite each other. Three free spring coils between claws. Compress alternately. Remove spring compressor **5041**.

I 16

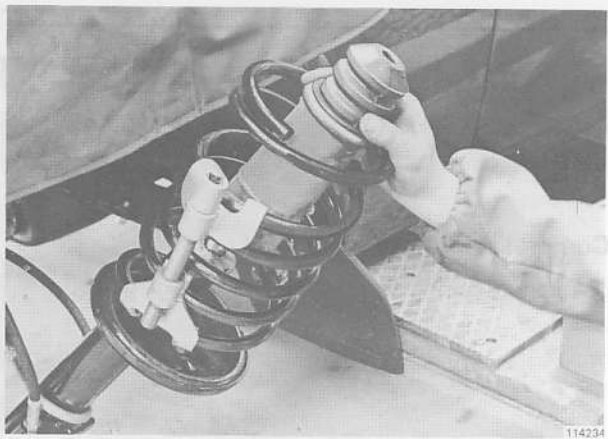

**Install spring.**

Turn spring so compressor claws face up. Install rubber bumper and dust cover.

I 17

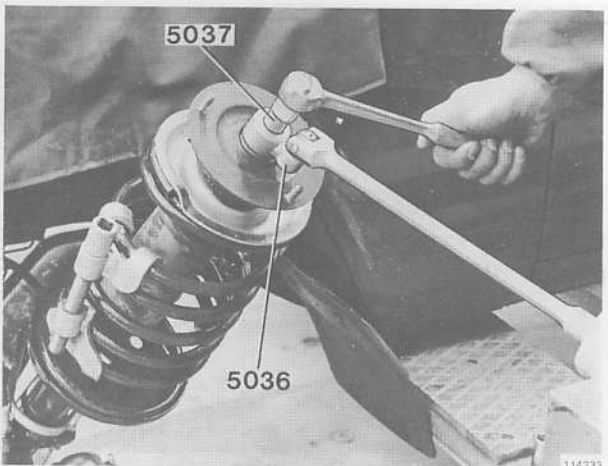

**Install journal.**

Install spring seat, upper journal, washer and nut. Use tool **5036** to tighten and **5037** to hold.

I 18

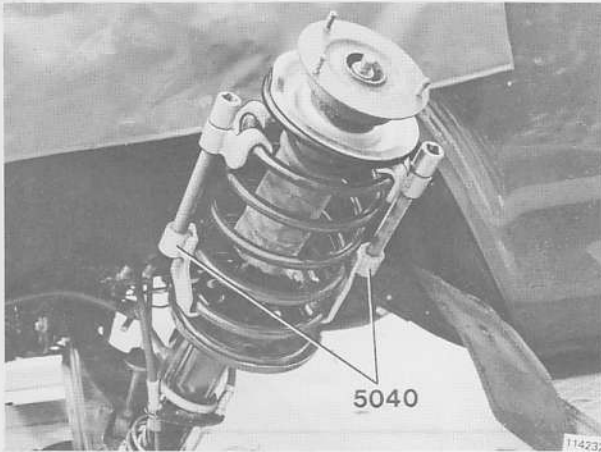

**Remove spring hook-up tool.**

Loosen tool alternately. Make sure spring ends position correctly in upper and lower seats.

I 19

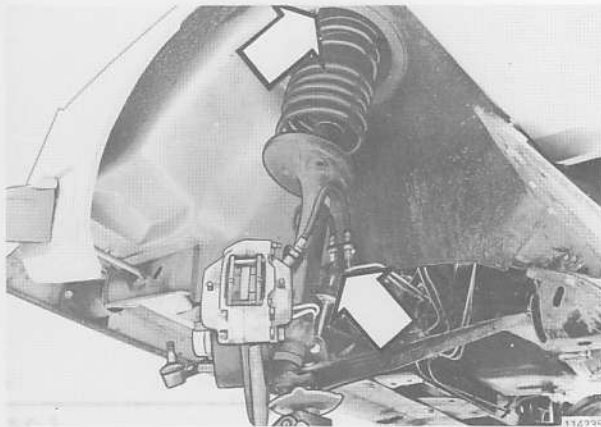

**Guide strut assembly into wheel housing.**

Remove retaining hook. Raise jack. Make sure that stabilizer link guides into position.

I 20

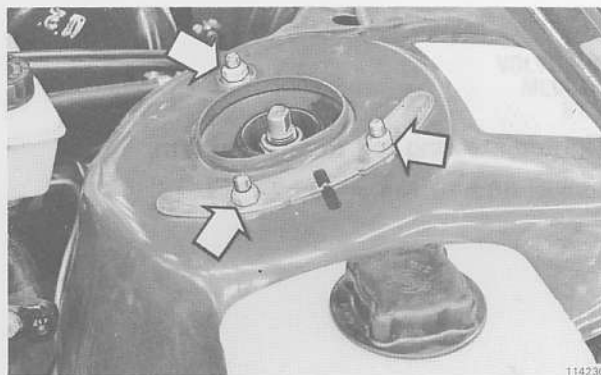

**Install journal.**

Position journal according to line-marks. Tighten nuts. Torque:  $20 \pm 5 \text{ Nm} = 14 \pm 4 \text{ ft.lbs.}$

I 21

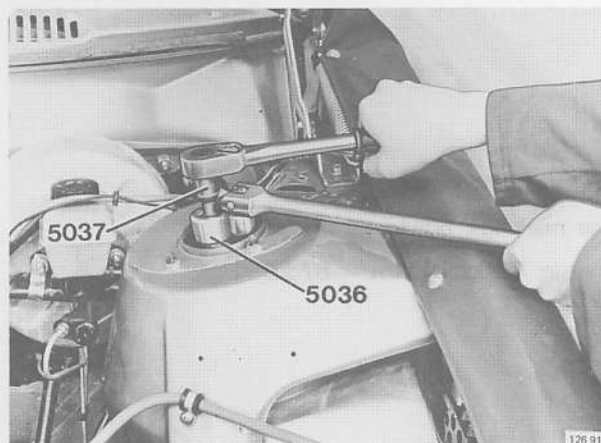

**Tighten center nut.**

Use tool 5036 to tighten and 5037 to hold. Press protective cover into position.

I 22

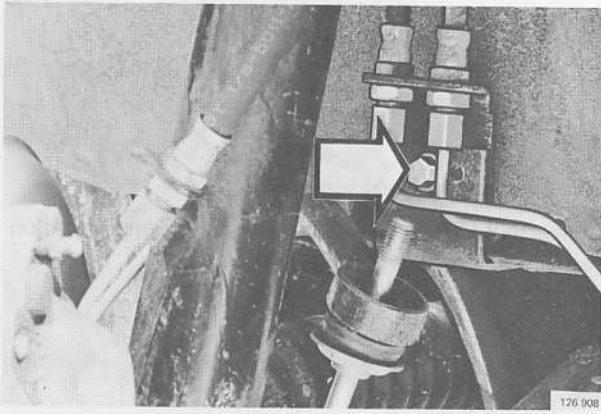

Tighten brake pipe bracket.

I 23

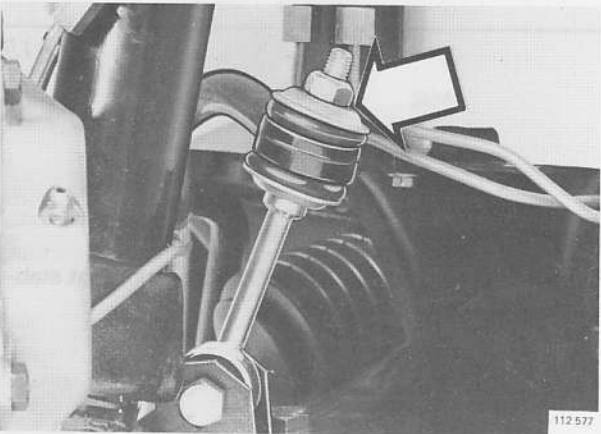

Tighten stabilizer link to bar.

I 24

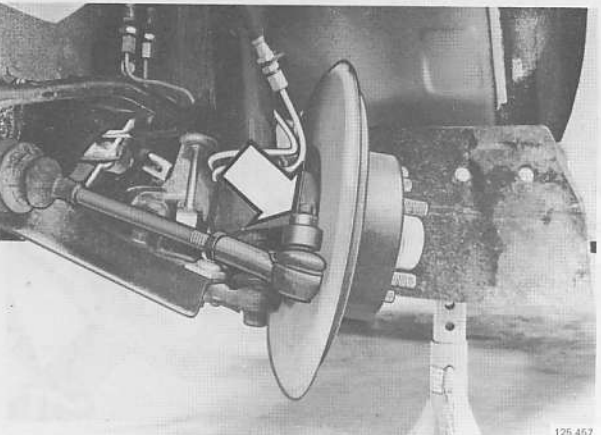

Tighten steering rod to steering arm.

Torque:  $60 \pm 10$  Nm =  $43 \pm 7$  ft.lbs.

I 25



Install front wheel.

Use markings, previously made.

Torque:  $120 \pm 20$  Nm =  $87 \pm 9$  ft.lbs.



**VOLVO SUPPORTS VOLUNTARY  
MECHANIC CERTIFICATION  
BY THE N.I.A.S.E.**

# VOLVO

TP 30000/1  
4500.3.79  
Printed in USA