

1 9 7 6 VOLVO 242, 244, 245

Notice to Owner: Your Volvo has been built to comply with all North American Safety and anti-pollution regulations and evidence of this can be verified from the certification label on the left wheel housing in the engine compartment. For further information regarding these regulations, please consult your local dealer.

Contents

(Index see page [91](#))

	DESCRIPTION Page
	Introduction 2
	Keys 3
	Instruments and controls 4
	Instruments 6
	Warning lights 7
	Ignition switch, parking brake 8
	Lighting 9
	Turn signals 10
	Wipers 11
	Clock, cigarette lighter, ash tray 12
	Tail gate window wiper, electrically heated rear window, hazard warning flasher 13
	Heating and ventilation 14
	Air conditioning 16
	Front seats 18
	Seat belts 20
	Doors and locks 22
	Rear doors, trunk lid 23
	Hood 24

[Vent windows, rear view mirrors 25](#)

[Interior light, sun roof, fuel tank cap 26](#)

[Rear seat, model 245 27](#)

[Tail gate, model 245 28](#)

START AND DRIVING

[Breaking in 31](#)

[Starting the engine 32](#)

[Gearshift positions 33](#)

[Automatic transmission 34](#)

[Emergency towing 36](#)

[Trailer hauling 38](#)

[Note 39](#)

MAINTENANCE SERVICE

[Maintenance Services 41](#)

[Gas station checks 42](#)

[Engine compartment 43](#)

[Maintenance schedule 44](#)

[Emission control system 50](#)

[Transmission oils 56](#)

[Rear axle, power steering, brake fluid 57](#)

[Lubrication 58](#)

[Coolant 59](#)

[Note: alternator 60](#)

[Replacing bulbs 60](#)

[Fuses 64](#)

[Wheels and tires 65](#)

[Wheel changing 66](#)

[Washing, cleaning 68](#)

[Cleaning, anti-rust treatment 69](#)

[Paint touch-up 70](#)

[Long distance trips 72](#)

[Cold weather 73](#)

[Service diagnosis 75](#)

pg. 2 General Information



pg. 3 Keys

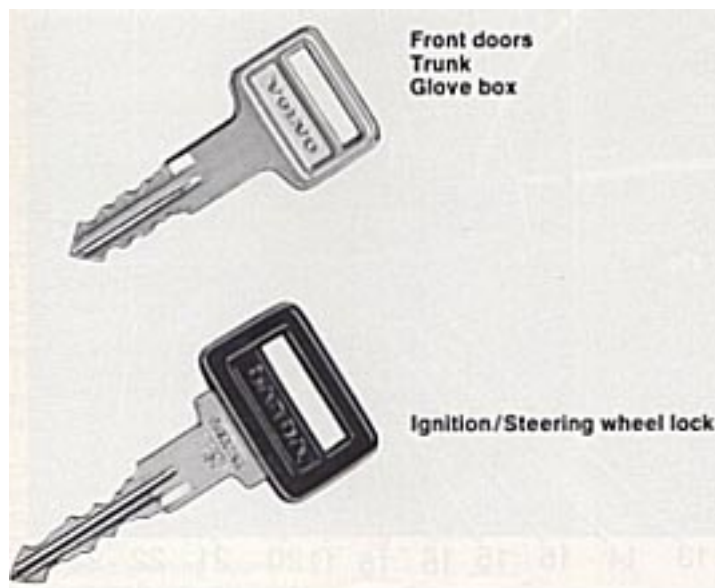

Record the number code of the keys.

In the event the original keys are lost, duplicates can be ordered through your Volvo dealer.



[Top of Page](#)

1976 VOLVO 242, 244, 245

pg. 4 Instruments and controls

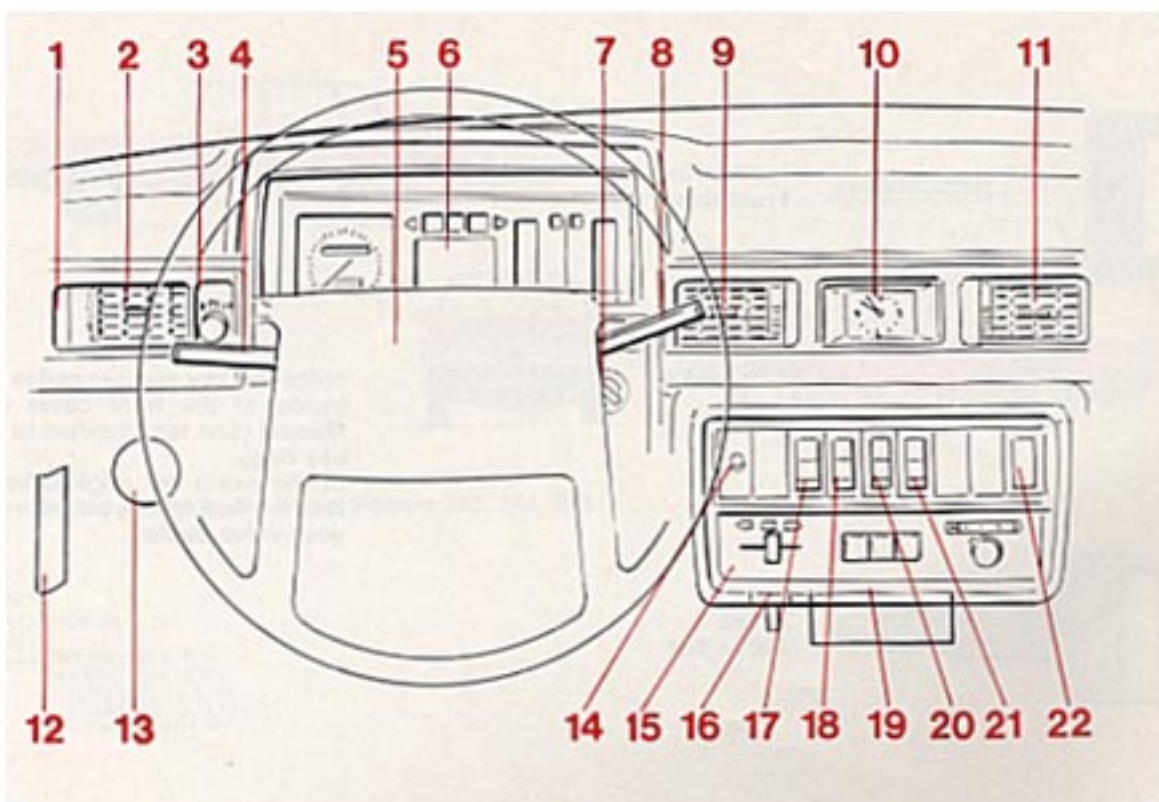

pg. 5 Instruments and controls

See page

1 Defroster outlet, side window [14](#)

2 Fresh air outlet [15](#)

3 Headlights, parking lights [9](#)

4 Turn signals [10](#)

5 Horn -

6 Instruments [6](#)

7 Ignition switch/steering wheel lock [8](#)

8 Wiper/washer [11](#)

9 Fresh air outlet [15](#)

10 Clock [12](#)

11 Fresh air outlet [15](#)

12 Fuse box [64](#)

13 Hood release handle [24](#)

14 Instrument lights [9](#)

15 Heating and ventilation [14](#)

16 Cigarette lighter [12](#)

17 Tail gate window wiper [13](#)

18 Electrically heated rear window [13](#)

19 Ash tray [12](#)

20 Air conditioning [16](#)

21 Hazard warning flasher [13](#)

22 Seat belt reminder light [20](#)

Pages 6-16 will give you a detailed description of the vehicle's instruments and controls. Note that vehicles may be differently equipped, depending on special legal requirements, etc.

pg. 6 Instruments

A Odometer

Mile reading.

B Speedometer

C Left turn signal indicator (green)

D Parking brake reminder light (red)

E High beam indicator (blue)

F Brake failure warning light (red)

G Right turn signal indicator (green)

H Oil pressure warning light (red)

I Alternator warning light (red)

J Trip odometer

(last figure represents 1/10 mile)

K Trip odometer reset knob

Push in to reset

L Reminder light, EGR Service

M Tachometer (certain models)

Reads thousand of engine rpm.

Orange range for momentary use, during acceleration.

Red prohibited range.

N Bulb failure warning light (yellow)

O Temperature gauge

The gauge pointer should normally remain inside the green range.

If the pointer enters the red range repeatedly, check coolant level and fan belt tension, see [page 49](#).

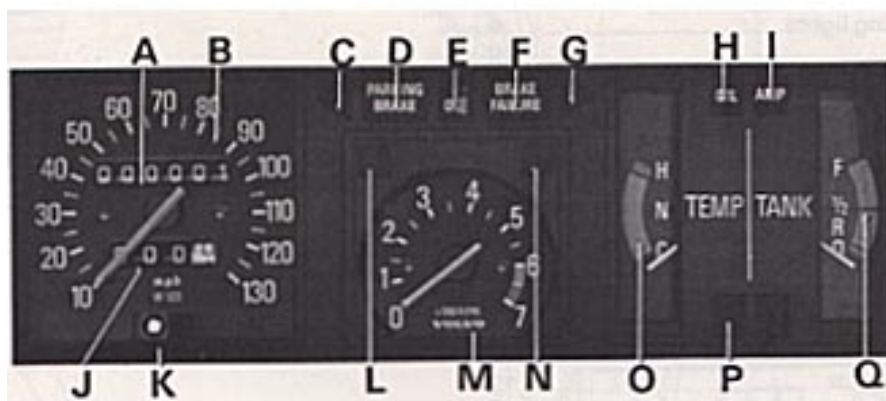

P Overdrive indicator light (green)

Lights when overdrive is engaged.

Q Fuel gauge

The fuel tank capacity is approx. 60 liters=15.8 US gals/13.2 Imp. gals

F Full

1/2

R Reserve

O Empty

The red range from R to O represents approx. 8 liters=2.5 US gals/2 Imp. gals.

pg. 7 Warning lights

The warning lights described on this page should never be on when driving

These lights will come on when the ignition key is turned "on", before the engine is started. This condition indicates that the lights function. The lights should go out once the engine has started. (However, the parking brake reminder light will not go out until the parking brake is fully released.)



D Parking brake reminder light (red)

This light will be on when the parking brake (hand brake) is set. The parking brake lever is situated between the front seats.



F Brake failure warning light (red)

If the light comes on while driving and the brake pedal can be depressed further than normal, it is an indication that one of the brake circuits is not functioning. Proceed cautiously to a Volvo dealer for a check.



H Oil pressure warning light (red)

If the light comes on while driving, the oil pressure is too low. Stop the engine immediately and check the engine oil level, see [page 48](#). After hard driving, the light will come on occasionally when the engine is idling. This is normal, provided it goes off when the engine speed is increased.



I Alternator warning light (red)

If the light comes on while the engine is running, check the tension of the alternator drive belt as soon as

possible. See [page 49](#)

NOTE:

This warning light is illuminated if the alternator drive belt is defective or damaged and the alternator not charging. **However, warning lights, D, F, L and N will be illuminated at the same time** due to the construction of the system.



L Reminder light EGR service (red)

If the vehicle is equipped with EGR (Exhaust Gas Recirculation) 15,000 service reminder light, as required by the U.S. Environmental Protection Agency, the light will come on at 15,000 mil intervals. This is a reminder to take your Volvo to your Volvo dealer to get the EGR valve serviced. The light will stay on until reset by your Volvo dealer.



N Bulb failure warning light (yellow)

The light will come on if any of the following bulbs are defective:

- one of the lower beams
- one of the tail lights
- one of the license plate lights
- one of the brake lights (when the brake pedal is depressed).

Bulb replacement, see [page 60-63](#).

pg. 8 Ignition switch, parking brake

Ignition switch/steering wheel lock

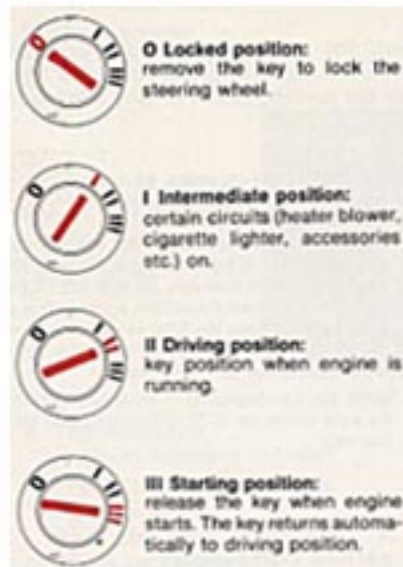

The steering wheel lock might be under tension when the car is parked. Turn the steering wheel slightly to free the ignition key.



Parking brake (hand brake)

The lever is situated between the front seats. The brake is applied to the rear wheels.

In order to obtain the best possible performance of the parking brake, the brake linings should be broken in, see [page 39](#).

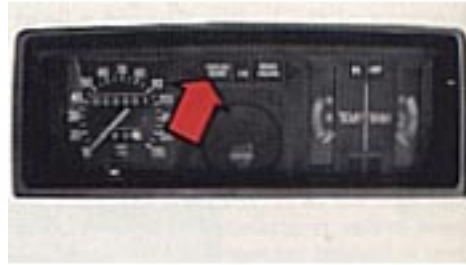

Parking brake reminder light

The reminder light PARKING BRAKE on the instrument panel comes on whenever the parking brake lever is not fully released and the ignition is on.

pg. 9 Lighting



Headlights and position lights

- All lights off
- Parking lights on
- Headlights and parking lights on

Switch from upper to lower beams, and vice versa, by moving the turn signal switch lever on the left side of the steering column towards the steering wheel. The lights can be used without switching on the ignition key.



Instrument light rheostat

Clockwise - brighter

Counterclockwise - dimmer.

pg. 10 Turn signals



Turn signals

1 Signal lever engaged for normal turns.

2 Lane change position. In maneuvers such as lane changing, the driver can flash the turn signals by moving the turn signal lever to the first stop and holding it there. The lever will return to the neutral position when released.



3 High and low beam switching (headlights on).

Move the lever towards the steering wheel and release it.

3 Headlight flasher (headlights off).

Move the lever towards the steering wheel. The headlight high beam will be on until the lever is released.

pg. 11 Wipers



Wiper/washer

1 "Single stroke" position.

Switch returns automatically when released.

2 Wipers, low speed.

3 Wipers, high speed.

4 Washer.

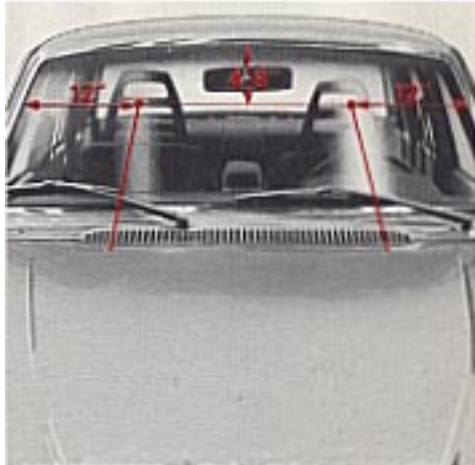

Adjusting washer nozzles

The nozzle may be adjusted by inserting a needle into the metal insert and rotating the nozzle.

The washer fluid reservoir is located in the engine compartment and holds approx. 6 liters =1.6 US gals /1.3 Imp gals.

pg. 12 Clock, cigarette lighter, ash tray



Clock

To reset the hands, push in the reset knob and turn.

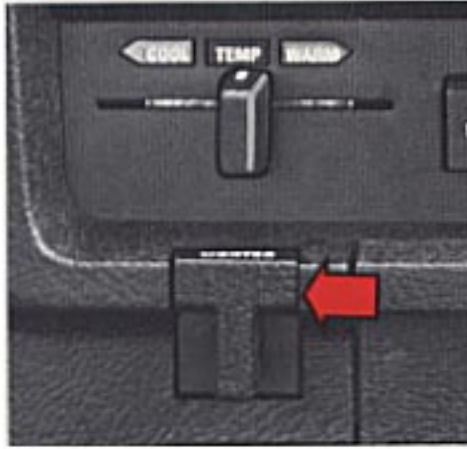

Cigarette lighter

To operate, depress the knob fully. When the knob automatically releases, the cigarette lighter is ready for use.



Ash trays

To remove the ash trays depress the center spring and remove.

pg. 13 Tailgate window wiper, el. heated rear window, hazard warning flasher

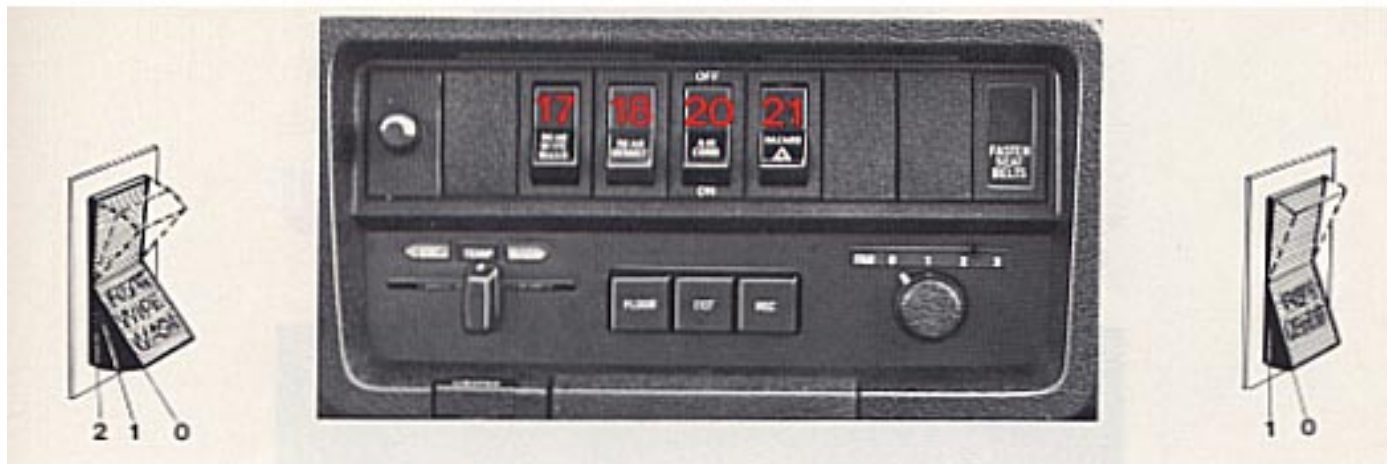

Tailgate window wiper/washer, (model 245) (17)

0 Off

1 Wiper and washer operating.

Move the lever to the first stop and hold it there.

2 Tailgate wiper only

The fluid reservoir is located in the concealed storage area under the floor on the right side of the rear cargo area. Reservoir capacity is approx. 1.5 qts.

Electrically heated rear window (18)

0 Off

1 On

Switch off the heated rear window when the glass is clear of mist or frost. Otherwise the battery will be unduly strained.

Do not place items against the inner surface of the rear window that may damage the printed circuit. Do not scrape the inner surface of the rear window glass with a hard object, otherwise damage to the printed circuit will occur.

Hazard warning flasher (21)

0 Off

1 On

Four-way flashing is used to indicate that the vehicle is at a standstill and has become a traffic hazard either during daylight or at night.

Note: Regulations regarding the use of the hazard warning flasher may vary from state to state.

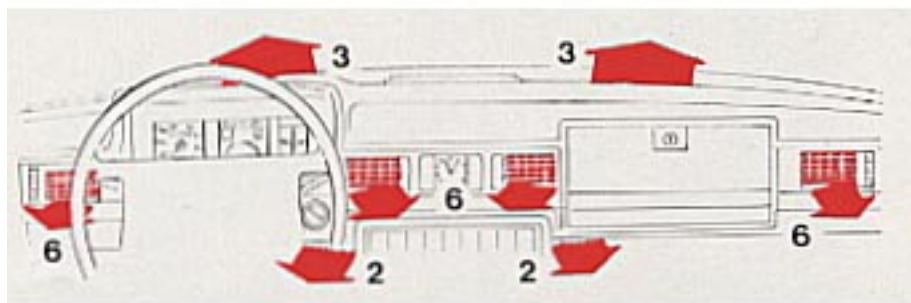

Heating system

1 TEMP

Left = cool

Right = warm

2 FLOOR

Out = no air to floor

In = full flow of air to floor

3 DEF (defrost)

Out = low volume air flow to defroster

In = full flow

4 REC (recirculation)

To be used only for cars equipped with air conditioning.

Do not use for heating.

5 FAN (Blower motor)

0 = off

1 = low speed

2 = medium speed

3 = high speed

6 Ventilation outlets

The air flow through the ventilation outlets is not influenced by the position of the FLOOR (2) and DEF (3) controls.



pg. 15 Heating and ventilation

How to . . .

. . . obtain max. heat

1 TEMP >>> WARM

2 FLOOR depressed

5 FAN >>> 2 (or 3)

6 All outlets halfway open.

. . . remove condensation

1 TEMP >>>WARM

3 DEF depressed

5 FAN >>> 2 (or 3)

Always keep front external inlet grille (in front of the windshield) clear of obstructions (snow, ice, etc.).

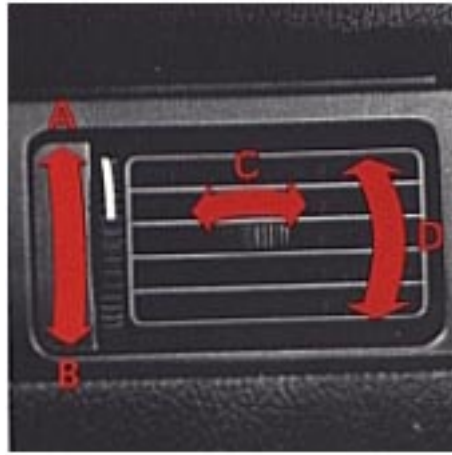

Fresh air outlets

A Closed

B Open

C Directing air flow horizontally

D Directing air flow vertically



[Contents](#) | [Top of Page](#)



Air conditioning (optional)

How to use the air conditioner:

1 FAN

Position 3 for rapid cooling.

The AC does not operate unless FAN is on.

2 AIR COND

Push in the button to start the compressor.

3 REC (Recirculation)

Push in for rapid cooling.

4 TEMP

Rotate to COOL for rapid cooling, then set to desired temperature.

To obtain rapid cooling, all windows must be closed and buttons FLOOR and DEF out.

All the air will then be discharged through the four dash outlets which should be fully open.

Note: For rapid removal of condensation from inside glass surfaces, the air conditioner can be switched on even when not required for interior cooling. The air conditioner will dehumidify the air inside the vehicle.

Have your Volvo dealer check the system for correct operation yearly.

This page left intentionally blank.

pg. 18 Front seats

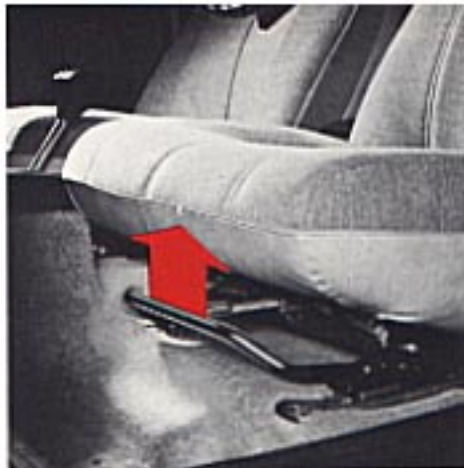

Horizontal seat adjustment



Seat back inclination adjustment



Lumbar support adjustment

pg. 19 Front seats

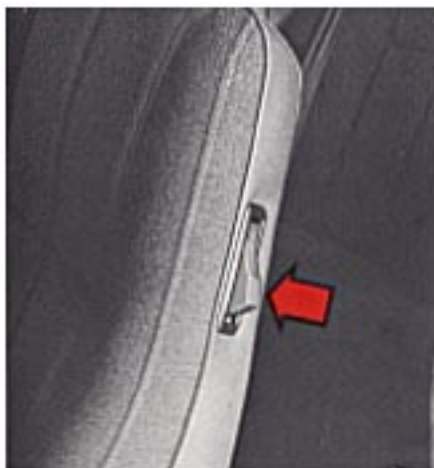

Seat back release, 2-door models

Press the button and fold forward.



Driver seat height

There are two levers, each with three positions, for adjusting the height of the front or the back of the seat.

This means that the seat cushion angle can be adjusted for comfort.

When adjusting the seat in any position check that it is securely latched.

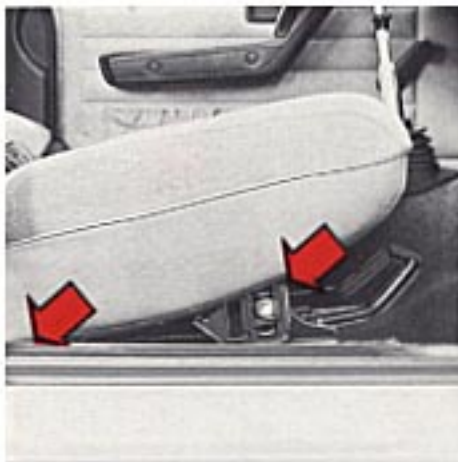

Passenger seat height

The front passenger seat is retained by four brackets, each with three positions. The positions are the same as for the driver's seat. However, this adjustment must be carried out manually using appropriate hand tools.

pg. 20 Seat belts



Seat belts, retractable

Use the seat belts whenever you drive or ride. Rear seat passengers should also use the seat belts as even heavy braking can have serious effects on an unbelted person.

A reminder light on the instrument panel will flash in case the vehicle is driven when the driver has not buckled up the seat belt.

Note that small children (up to the age of 8-10 years) should not use Adult type seat belt.
The front and the rear outboard seats are provided with self-retracting inertia belts.



To buckle:

Pull the belt out slowly, far enough to insert the latch plate into the buckle, until a snap is heard. The belt should not be twisted or turned. To unfasten, depress red push button in buckle. Let the belts rewind into their retractors.

The seat belts are normally "unlocked". The seat belt locks and cannot be pulled out:

- if it is pulled out rapidly
- during braking and acceleration
- if the vehicle is leaning excessively
- when driving in turns



Check seat belt mechanism function as follows:

- Attach the seat belt. Pull heavily on the strap.
- Brake hard from approximately 30 mph (50 km/h) or drive in a tight circle (check other traffic first!)

Pull on the belt.

In these cases the belt should not be able to be pulled out.

pg. 21 Seat belts



Seat belts, manually adjustable

The center rear seat belt is a manually adjustable belt. It should always be adjusted to the correct length. To lengthen: turn the buckle and pull it out, as shown in the picture.



To shorten, pull the upper part of the double webbing.

Maintenance

Check periodically that the bolts are secure and the belt in good condition. Use water and a detergent for cleaning.

As the seat belts lose much of their strength when exposed to violent stretching, they should be replaced after collision, even though they may appear to be undamaged.

Never modify or repair the belt on your own, but have this done by a Volvo workshop.

pg. 22 Doors and locks

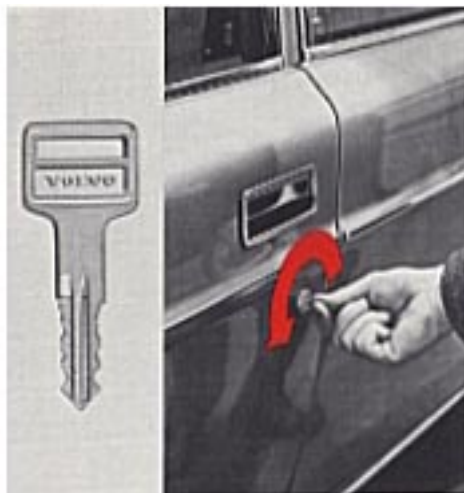

Unlocking front doors

Both front doors can be unlocked by using the key. Turning the key 1/4 turn counterclockwise lifts the lock buttons on the window ledge and the door can be opened by pulling the handle.



Locking doors

All doors can be locked by depressing the lock buttons. To lock the front doors, press down the lock button and keep the door handle pulled out while shutting the door.

To lock the rear doors, press down the lock button and shut the door. It is not necessary to keep the door handle pulled out.

To open a rear door from inside, the lock button must first be pulled up.

The lock buttons should not be in the down position during driving. In case of an accident, it

prevents aid from entering the vehicle.

In wintertime the door locks should be "lubricated" with a suitable agent to prevent freezing. If the lock is frozen, be careful not to break the key in the lock. Thaw the ice by heating the lock or the key.

pg. 23 Rear doors, trunk lid



Child safety locks, 244 and 245

The buttons are located on the rear door jambs.

A Normal lock function.

B The door cannot be opened from the **inside**.



Trunk lid, 242 and 244

To open the lid, turn the knob clockwise.

NOTE: The key must be removed from the lock in order to permit turning of the knob.

The spare wheel, jack and tool kit are stowed on the left side of the trunk.

pg. 24 Hood

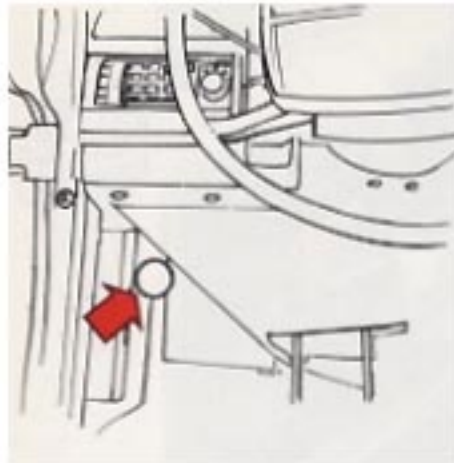

To open the hood

Pull the release handle (located on the left side under the dash).

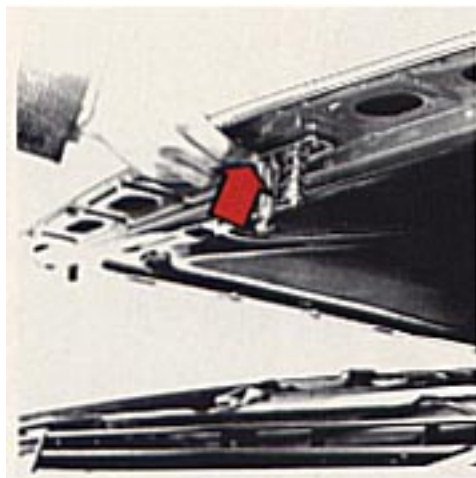

Lift the hood slightly, insert a hand under the center line of the hood and depress the safety catch handle. Open the hood.

Check that the hood locks properly when closing.

pg. 25 Vent windows, rear view mirrors

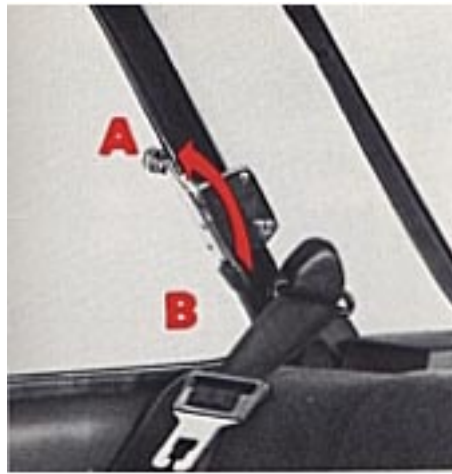

Rear vent windows, 2-door models

- A Open
- B Closed

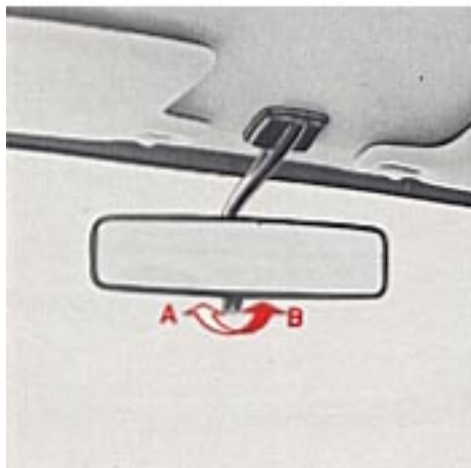

Inside mirror

- A Normal position
- B Night position, reduces glare from following headlights



Outside mirrors

A Adjustment sideways

B Adjustment up/down

The mirrors should always be adjusted before driving.

pg. 26 Interior lights, sun roof, fuel tank cap



Interior light

1 Light always on.

2 Light always off.

3 Light on when either front door is opened.

Model 245 may be provided with a light that differs from that in the 242-244.



Sun roof (certain models)

The sun roof is operated by a handle located between the sun visors.

Unfold the handle and turn it counterclockwise to open, clockwise to close.

For safety reasons, the handle should always be folded when driving.



Filling fuel

The gas cap is located behind the door on the right rear fender. When filling, position the cap in the special bracket on the door.

Note: Unleaded fuel is required for certain models. A label on the instrument panel and rear fender, near the filler inlet will remind owners and filling station attendant of this requirement. Important! It is unlawful to dispense leaded fuel into any vehicle labeled "unleaded Gasoline only".

pg. 27 Rear seat, model 245



Folding rear seat

Depress either lever located at the front bottom edge of the rear seat cushion (right or left side). Tilt the seat towards the front seat.



Pull up on either of the parallel-connected handles on the rear side of the seat back and fold the seat back forward and down so that it lies flat. The rear seat back and cushion are fixed automatically in their respective positions.

When replacing the rear seat to its normal position, make sure the latches are securely locked and the seat belts lie on top of the seat back so they can easily be used.

pg. 28 Model 245, tailgate

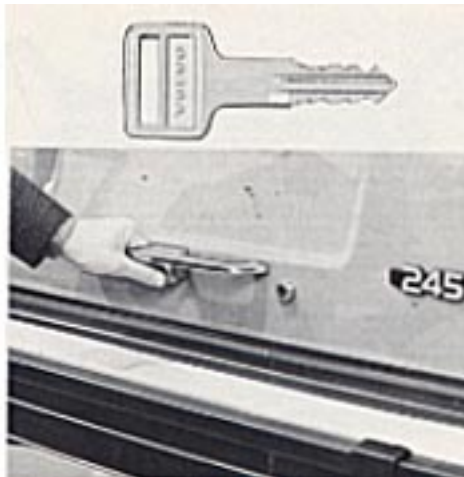

To open from the outside

Use the front door key. Depress the release button located under the tail gate handle.



To open from the inside

Pull out the handle at the gate bottom.

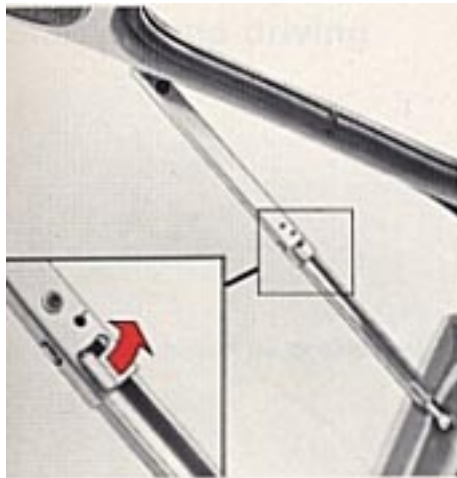

To close

Push the red catch upwards and at the same time lift the gate 1/4 inch. Close the gate slowly but firmly.

pg. 29 Tail gate, model 245

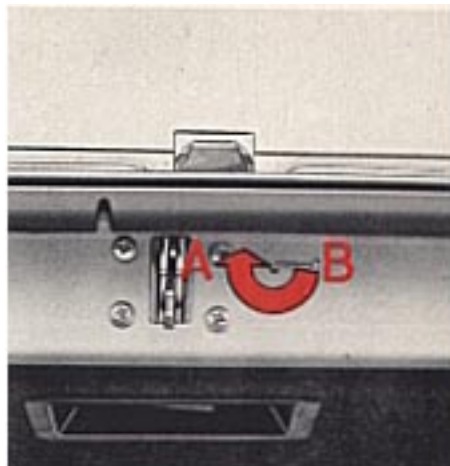

Safety catch

- A The lid cannot be opened from the inside.
- B The lock functions normally.

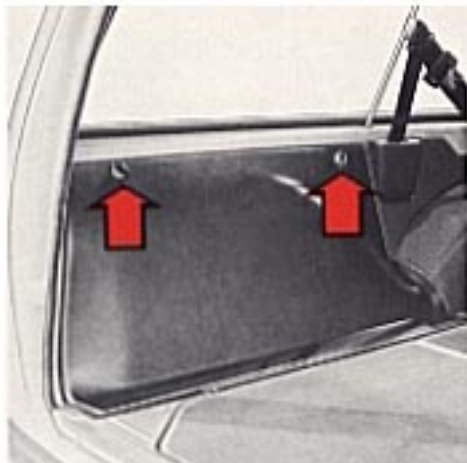

Spare wheel

Remove the two screws and lift off the cover. The spare wheel is now accessible.



Concealed storage space

There are two concealed stowing places under the cargo compartment floor. The tail gate window washer fluid reservoir and the jack are located in the right hand one.

This page left intentionally blank.



1 9 7 6 VOLVO 242, 244, 245

pg. 31 Breaking in

STARTING AND DRIVING



A new car should be broken in!

During the break-in period do not exceed the following speeds:

First 600 miles (1,000 km)

- 1st gear 20 mph (30 km/h)
- 2nd gear 35 mph (55 km/h)
- 3rd gear 50 mph (80 km/h)
- 4th gear 70 mph (110 km/h)

600-1,200 miles (1,000-2,000 km)

- 1st gear 20 mph (35 km/h)
- 2nd gear 40 mph (65 km/h)
- 3rd gear 60 mph (100 km/h)
- 4th gear 80 mph (130 km/h)

Avoid driving at low speed in high gear. Do not use "kick-down" when driving a car equipped with an

automatic transmission during the first 1,200 miles.

Service Inspection

To ensure proper operation the car should be taken to a Volvo dealer after the first 600 miles for a service inspection. The oil in the engine, transmission and rear axle will then be changed. This is very important since the oil rapidly collects impurities during the break-in period.

Every Volvo engine is test-driven prior to delivery. Volvo is therefore assured that all clearances are satisfactory and thus accepts no responsibility for damage caused by careless or harsh driving during the break-in period.

pg. 32 Starting the engine

To start the engine:

- 1 Enter the car and fasten the seat belt.**
- 2 Apply the parking brake, if not already set.**
- 3 Place the gear selector lever in neutral (position N or P, automatic transmission).**
- 4 Depress the clutch pedal.**
- 5 Do not touch the throttle pedal.**
- 6 Turn the ignition key to starting position. Release the key as soon as the engine starts.**

If the engine does not start at once, depress the throttle pedal half way and keep it there until the engine starts.

Avoid repeated short attempts to start (fuel is injected every time the starter is engaged). Allow the starter to operate for a longer time (but not more than 15-20 seconds).

Do not race the engine immediately after starting when cold.

WARNING!

Always open the garage doors fully before starting in a garage . The exhaust gases contain carbon monoxide, which is invisible and odorless but very poisonous.

Engine warm-up - initial driving procedure

Experience shows that engines in vehicles driven short distances are subject to abnormally rapid wear because the engine never reaches normal operating temperature.

It is therefore beneficial to reach normal operating temperature as fast as possible. This is achieved by driving with a light load as soon as possible.

pg. 33 Gear shift positions



4-speed transmission

Depress the clutch fully when changing gears.



Overdrive (some models only)

The overdrive can be engaged in 4th gear only.

No extra operation of clutch or throttle pedal is normally necessary. **Engagement** is facilitated if the accelerator pedal position is maintained steady.

When **disengaging**, depressing the clutch pedal slightly makes a smooth transfer.

Do **not** use the overdrive at speeds below 40 mph (60 km/h).



Reversing inhibitor

Lift the ring to enter reverse gear. The ring locking mechanism prevents reverse gear from being engaged unintentionally.

pg. 34 Automatic transmission

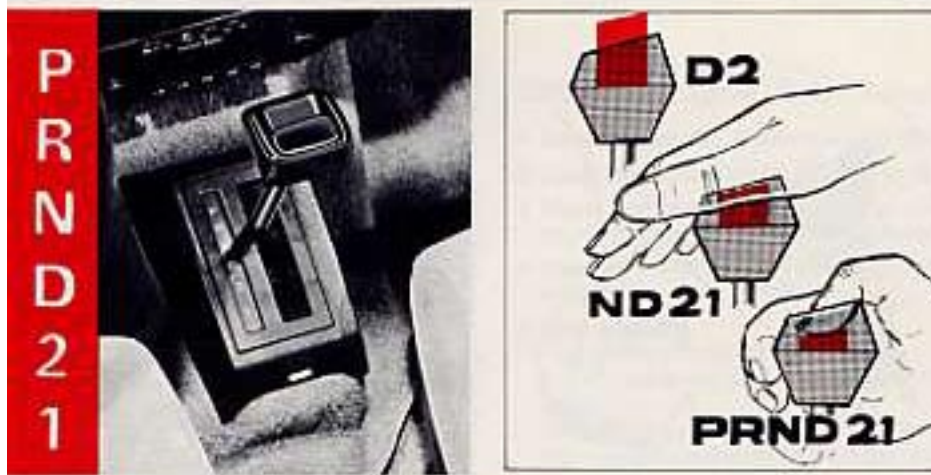

Shift positions

- P park
- R reverse
- N neutral
- D drive
- 2 , 1 low gear

The gear selector can be moved freely between D and 2. The other positions are separated by a lockout which is operated by depressing the selector knob.

Shift gate

Depressing the selector knob slightly allows selection of positions **N** and **1**.

Depressing the selector knob fully allows selection of positions **R** and **P**. This is also necessary when initially bringing the selector out of position **P**.

Depressing the selector knob fully thus permits shifting freely between all positions.

P Parking

Use this position when parked with the engine running or stopped.

Never use P while car is in motion.

The transmission is mechanically locked in position P. Also use the parking brake when parking on grades.

R Reverse

Never use R while car is in motion.

N Neutral

Neutral position = no gear is engaged.

Driving gears

D Drive

D is the normal driving position. Up- and downshift between the three forward gears occurs automatically and is governed by throttle opening and speed.

pg. 35 Automatic transmission

2, intermediate position

Up- and downshift automatically between positions 1 and 2. (low and intermediate).

No upshift to 3rd gear (top gear).

Position 2 can be used to obtain immediate downshifting to 2nd gear (increased "engine braking effect").

Position 2 can be used...

- for relatively slow highway driving.
- for city driving.
- when driving on mountain roads where precise speed control is desirable.
- for passing.
- to increase "engine braking effect".

Top speed when selecting 2: 70 mph (110 km/h).

1, low position

If position 1 is selected when driving at high speeds, 2 is engaged first and 1 when the speed has dropped to approx. 30 mph (50 km/h).

NOTE: No upshift once 1 is engaged.

Use position 1 when you want a low gear with no upshift, for instance, when entering and descending steep grades.

Top speed when selecting 1: 70 mph (110 km/h).

Kick-down

By depressing the throttle pedal briskly (passing the normal full throttle position) automatic shift to a lower gear is achieved.

When approaching the top speed for a particular gear or by releasing the throttle pedal slightly an upshift will be achieved.

Kick-down can be used for maximum acceleration, for instance, passing at highway speeds.

Starting and stopping a car equipped with automatic transmission

1 Enter the car and fasten the seat belts.

2 Apply the parking brake or the brake pedal to hold the car (or the car will start moving when the gear selector is moved).

3 Select position **P** or **N**. (Engine cannot be started in any other position).

4 Start the engine by turning the ignition key.

5 Select the desired gear.

6 Release the brake and accelerate.

To stop the car, release the throttle pedal and apply the brakes.

It is not necessary to move the gear selector. The transmission will down shift automatically.

Rocking the car

If the car becomes stuck in snow, sand or mud, it can often be moved by a rocking motion. Move the gear selector rhythmically between **D** and **R** while applying slight pressure to the throttle pedal.

NOTE:

- **Never select P or R while the car is in motion.**
- **The engine should be idling when selecting D, 2, 1 or R with the car standing still.**
- **Never select positions 2 or 1 at speeds above 70 mph (110 km/h).**



Front eyelet

To the right, under the car.

Rear eyelet

To the right, under the car.

Precautionary steps to observe when towing

Steering must be unlocked.

Observe legal speeds.

Remember that power brake and power steering assists will not be available when engine is inoperative.

Pedal pressure is 3 - 4 times normal and steering effort increased.

Towing cars equipped with automatic transmission: Gear selector in position N. Check transmission oil level (see [page 56](#)).

Maximum speed: 20 mph (30 km/h).

Maximum distance: 20 miles (30 km).

THE ENGINE CANNOT BE STARTED BY PUSHING OR PULLING THE CAR.

When jump-starting, observe that the booster battery + must be connected to the car battery +. The booster battery - must be connected to the car battery-. Any other connection will damage alternator and electronic components.

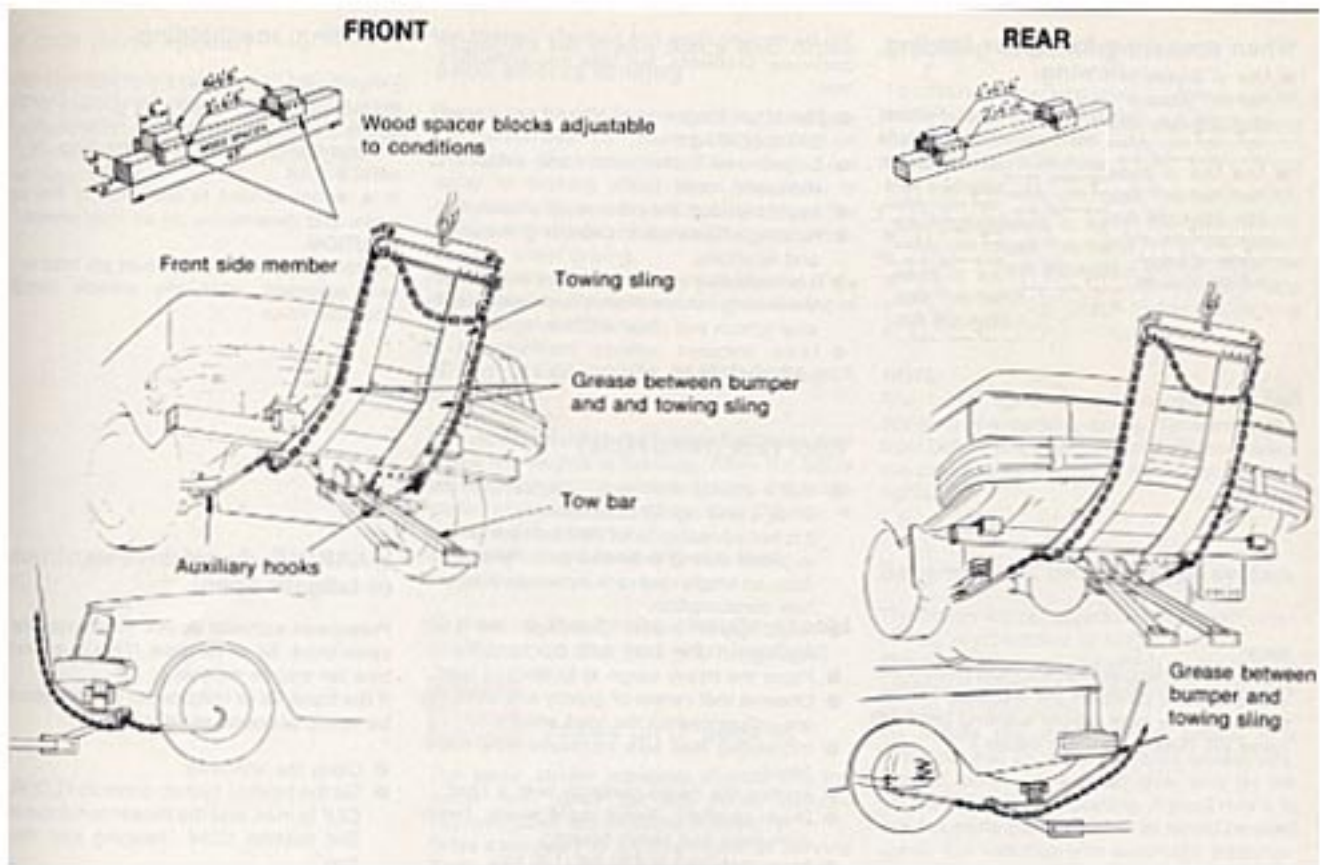

pg. 38 Trailer hauling

When preparing for trailer hauling, observe the following:

- Use an approved trailer hitch (available through Volvo dealers).
 - Maximum trailer weight recommended by Volvo is 2,000 lbs (908 kg).
- Observe legal requirements.

NOTE:

Additional lighting equipment must be connected to specific points in the electrical system. Otherwise the bulb failure warning light will come on. (See your Volvo dealer.)

Trailer hauling does not normally present any particular problems, but take into consideration:

- the hitch tongue load should not exceed 160-200 lbs (75-90 kgs).
- engine and transmission are subject to increased loads.
- avoid overload and other abusive operation.
- hauling a trailer affects handling, durability and economy.
- it is necessary to balance trailer brakes with the towing vehicle brakes to provide a safe stop.
- more frequent vehicle maintenance is required.

Roof rack

- Use a strong roof rack which is intended for the vehicle and can be rigidly attached. The Volvo dealers furnish roof racks developed by the Volvo factory.
- Avoid point loads, distribute the load evenly.
- Place the heavy cargo at bottom of load.
- Observe that center of gravity and handling are influenced by the load weight.
- Increasing load size increases wind resistance.
- Anchor the cargo correctly with a cord.
- Drive smoothly, avoid rapid starts, heavy cornering and heavy braking.
- Max. roof load is 220 lbs (100 kg).

pg. 39 Note

Handling, roadholding

At normal operating load your Volvo has a tendency to understeer. This means that in a certain curve the steering wheel has to be moved further to obtain the same response when driving faster. This makes the car stable and decreases the chances of rear wheel skid.

Varying loads and tire pressures will affect understeer. Therefore Volvo advises not to experiment with tire pressures and instead follow Volvo recommendations.

Volvo also warns against mixing tires of different kinds, as for instance Bias ply tires and radial tires. This will considerably alter the car's handling properties.

Driving with trunk lid open

Exhaust gases can be sucked into the car. This is especially true for the 245 (Wagon).

Normally this involves no hazard to the passengers, but the following advice should be followed as a safety precaution.

1. Close all windows.
2. Set the heating system's FLOOR and DEF controls to MAX and the fan to full speed (3). See [page 14](#).

Moisture on brake discs and brake pads affects braking.

Rain and slush as well as normal car wash will moisten the brake components. This may affect the friction of the brake pads and a delay in braking effectiveness will be noticed.

When driving in slush or rain, depress the brake pedal now and then in order to heat the brake linings and remove the moisture. This should also be done immediately after washing or starting in very damp weather.

If the brake power assist does not function

The power assist to the brakes functions only when the engine is running. When coasting, or towing, the brake pedal pressure must be increased 3-4 times.

The brake pedal feels stiff and hard.

If one of the brake circuits should malfunction the red warning light comes on, (F [page 6](#))

The pedal stroke increases slightly and the pedal feels softer but the pedal pressure required does not increase noticeably.

Drive carefully to a Volvo dealer or Service Station to have the brake system checked.

Breaking in parking brakes

To obtain best parking brake performance, the brake linings should be broken in.

Stop 5-7 times from 30 mph, transmission in neutral. Apply the handbrake lever, release button pressed in during the stop.

The force must not lock the rear wheels. If this happens, release the brake enough to let the wheels rotate. Drive a mile between each stop to cool the brakes.

NOTE:

The stop lights are not illuminated when applying the parking brake. To warn traffic from behind it is therefore advisable to depress the brake pedal slightly to illuminate the stop lights.

Severe strain on the brake system.

The brakes will be subject to severe strain when driving in mountains or hilly areas.

The speed is usually low which means that the cooling of the brake is less efficient than when driving on level roads.

To reduce the strain on the brakes it is advisable not to use the brakes excessively.

Instead, shift into a lower gear and let the engine help with the braking. A good rule is to use the same gear downhill as would be used uphill. For vehicles with automatic transmission use position 2 or in some cases 1.

This page left intentionally blank



1 9 7 6 VOLVO 242, 244, 245

pg. 41 Maintenance services

MAINTENANCE

Maintenance services

Your Volvo has passed two major inspections before it was delivered to you. One was made at the Volvo factory and one was performed by the dealer, according to Volvo specifications.

When driven 600 miles your car should be brought to the Volvo dealer who will perform a service inspection; engine, transmission and rear axle oils, for instance, will be changed.

Following this inspection, maintenance inspections as outlined in this book should be performed every 7,500 miles.

The extended maintenance inspection intervals make it even more advisable to follow this program.

Inspection and service should also be performed any time a malfunction is observed or suspected.

Retain receipts for all vehicle emission services to protect your emission warranty.

See your "Warranties and Maintenance Record book".

Maintenance inspection 7,500 mile intervals

Volvo advises you to follow the inspection program at 7,500 mile intervals which is outlined in the "Warranties and Maintenance Record book". This maintenance program consists of inspections and services necessary for the proper operation of your car over the next 7,500 miles.

The maintenance inspections includes several checks which require special instruments and tools and therefore must be performed by a qualified Volvo technician.

THE FEDERAL CLEAN AIR ACT (USA)

The Clean Air Act requires vehicle manufacturers to furnish written instructions to the ultimate purchaser to assure the proper functioning of those components that control emissions.

The maintenance instructions listed on [pages 44, 45](#) represent the minimum maintenance required. These services are not covered by the warranty. You will be required to pay for labor and material used. Refer to your "Warranties and Maintenance Record book" for further details.

pg. 42 Gas station checks

Fuel RON 91

Octane rating 91

For vehicles with catalytic converter **unleaded fuel must be used.**

Vehicles not equipped with catalytic converter can use leaded or unleaded fuel. (see also [page 26](#)).

Engine oil

Maintain oil level between the dipstick marks. The distance between the marks represents 1 quart (1 liter). Engine oil For API service SE" SAE 10 W-40.

See also [page 48](#).

Coolant

Maintain fluid level between MAX and MIN marks on expansion tank.

Mixture of 50% anti-freeze and 50% water.

Washer fluid

Washer fluid reservoir.

Water and solvent (wintertime: use windshield washer anti-freeze).

Brake fluid

Check, without removing the cap, that the level is above the MIN mark.

Brake fluid DOT 3 or DOT 4(SAE J 1703).

Battery

Acid level 1/4" - 3/8" above plates.

Use distilled water only, **never** add acid.

WARNING! battery gases are explosive.

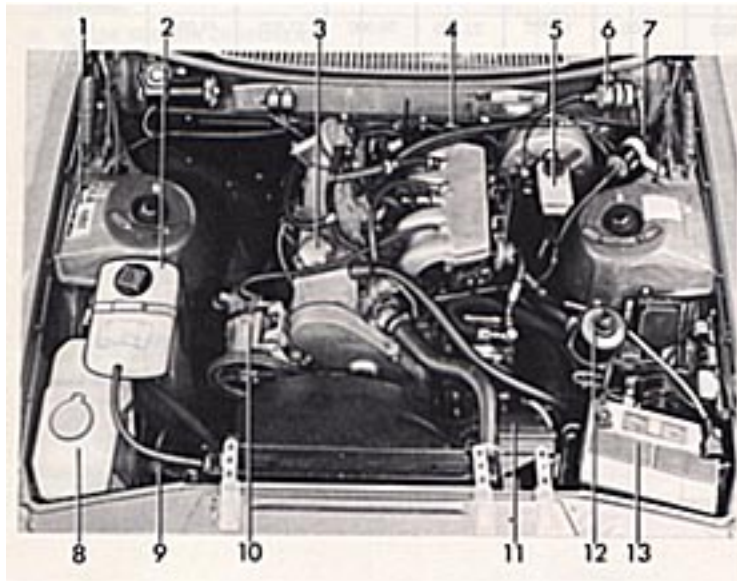

Engine B21F

- 1 Data plate
- 2 Expansion tank
- 3 Oil filler cap, engine
- 4 Oil dipstick, engine
- 5 Brake fluid reservoir
- 6 Fuel filter
- 7 Ignition coil
- 8 Washer fluid reservoir
- 9 Carbon canister, evaporative control system
- 10 Air Injection Reactor Pump
- 11 Air cleaner
- 12 Oil reservoir, power steering
- 13 Battery

pg. 44 Servicing

1976 MAINTENANCE SCHEDULE 242 244 245

A= Adjust

R= Replace

I= Inspect (Correct or Replace if necessary)

L= Lubricate

Maintenance Operation	Miles	600	7,500	15,000	22,500	30,000	37,500	45,000
EMISSION CONTROL SYSTEM								
I ENGINE MECHANICAL COMPONENTS								
Engine Oil and Filter *	R	R	R	R	R	R	R	R
Engine Coolant					R			
Cooling System Hoses and Connections	I		I		I			I
Engine Drive Belts	A	I	I	I	I	I	I	I
Torque Cylinder Head Bolts	A							
Torque Manifold Bolts	A							
Valve Clearance	I		I		I			I
Camshaft drive belt	A		A		A			R
Vacuum Fittings, Hoses and Connections	I		I		I			I
II ENGINE FUEL SYSTEM								
Fuel (Line) Filter					R			
Fuel (Tank) Filter			I		I			I
Air Cleaner Filter					R			
Idle RPM	A		I		I			I
Mixture Ratio	I		I		I			I
Fuel System Cap, Tank, Lines and Connections	I				I			
Fuel Injection Electrical Connections			I		I			I

*Change oil at least twice a year.

However, adverse conditions (like hot ambient temperatures, trailer pulling, hill climbing, driving long distances at high speeds, extended periods of idling or low speed operation, short trip operation at freezing temperatures) require oil changes more frequently (every three months).

pg. 45 Servicing

**1976
MAINTENANCE SCHEDULE
242 244 245**

A= Adjust

R= Replace

I= Inspect (Correct or Replace if necessary)

L= Lubricate

Maintenance Operation	Miles	600	7,500	15,000	22,500	30,000	37,500	45,000
EMISSION CONTROL SYSTEM								
III ENGINE IGNITION COMPONENTS								
Spark Plugs(see also page 52)			R			R		R
Distributor Advance Mechanism						I		
Ignition Timing			I			I		I
Distributor Cap and Rotor			I			I		I
Ignition Wiring			I			I		I
IV ENGINE CRANKCASE VENTILATION SYSTEM								
PCV Nipple (Orifice)			I			I		I
Ventilation Hoses			I			I		I
Oil Filter Breather Cap and Flame Arrester			I			I		I
V ENGINE EXTERNAL EMISSIONS								
Exhaust Gas Recirculation Components**			**I			**R		**I
Throttle Valve Switch			I			I		I
Air Injection Reactor System			I			I		I
Catalytic Converter Mounting Bolts	A		A			A		A
VI ENGINE EVAPORATIVE EMISSIONS								
Evaporative Control Canister								R

** EGR valve is cleaned at 15,000 and 45,000-mile intervals and is replaced every 30,000 miles.

pg. 46 Servicing

**1976
MAINTENANCE SCHEDULE
242 244 245**

A= Adjust

R= Replace

I= Inspect (Correct or Replace if necessary)

L= Lubricate

Maintenance Operation	Miles	600	7,500	15,000	22,500	30,000	37,500	45,000
DRIVE TRAIN								
Manual Transmission Oil	R	I	I	I	R	I	I	
Automatic Transmission Oil	I	I	I	I	I ¹⁾	I	I	
Rear Axle Oil	R	I	I	I	I	I	I	
BRAKES								
Inspect brakes, replace components as necessary.			I		I		I	
Change Brake Fluid								R
STEERING								
Tire Wear (Align Front End if needed.)	I	I	I	I	I	I	I	
Check power steering fluid level.	I	I	I	I	I	I	I	
BODY								
Trunk, Door and Hood Hinges and Latches.	L	L	L	L	L	L	L	

1) For cars used for hard driving, or in hilly terrain etc, preventive service including oil change should be carried out every 30,000 miles.

pg. 47 Servicing

The following items should be checked weekly by the driver. This only takes a few moments.

Engine oil level

Description on page

[48](#)

Brake fluid

[57](#)

Radiator coolant level

[59](#)

Battery water level

[42](#)

Tire pressure, all five tires

[85](#)

Operation of all lights

-

Horns

-

Windshield wipers

-

Level of windshield fluid

-

The following should also be carried out regular intervals.

Description on page

Washing

[68](#)

Polishing

[68](#)

Cleaning

[69](#)

Rust protection

[69](#)

pg. 48 Engine oil



Checking oil level

Check the oil level each time you stop for gasoline. The level should be between the dipstick marks. It must not drop below the lower mark. On the other hand, it should not exceed the upper mark since excessive oil consumption will result. The distance between the dipstick marks represents 1 quart of oil.

To add oil or change oil

Add oil of the same kind as already used.

Multigrade oils, Service SE classification are recommended.

All year round SAE 10W-40, SAE 10W-30, SAE 10W-50

Above +14°F (-10°C) SAE 20W-50

At very low temperatures (below 0°F) multigrade oil SAE 5W-20 is recommended. However, this oil should not be used when the temperature is continuously above 32°F.

Oil and oil filter cartridge are replaced the first time at the 600 mile inspection. Subsequent oil and filter changes are made at 7,500 mile intervals or **at least twice a year**. However, under adverse conditions, such as high ambient temperatures, trailer pulling, hill climbing, driving long distances at high speeds, extended periods of idling or low speed operation, short trip operation at freezing temperatures oil changes are required more frequently (every three months).

Drain the oil after driving while it is still hot.

Capacity excl. filter 3.5 US qts/3.0 Imp. qts.

incl. filter 4.0 US qts/3.4 Imp. qts.

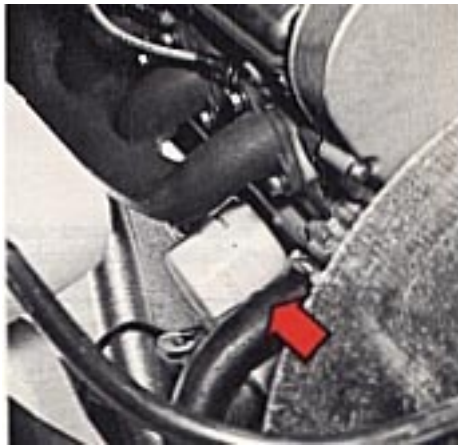

Changing oil filter

Replace the oil filter at every oil change. If the oil filter for any reason is changed separately 1/2 qt. of oil should be added.

pg. 49 Cooling system



Changing coolant

Every two years or 30,000 miles the cooling system should be drained, flushed and re-filled.

Remove the expansion tank cap.

Loosen the hose at the radiator bottom and open the drain cock on right side of the engine block.

Fill coolant through the expansion tank.

The heater controls should be fully open when draining and filling.

Add coolant until the level is up to the MAX mark or slightly above.

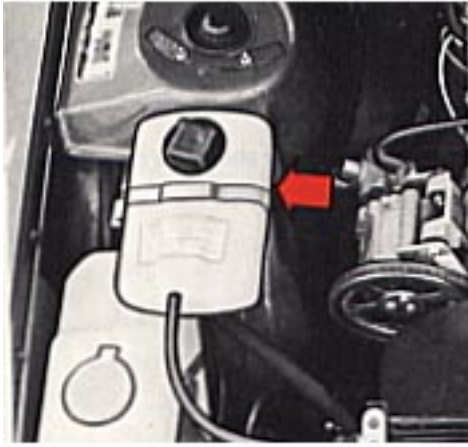

Start engine and run until hot. Check the cooling system connections for tightness. Also re-check the coolant level.

Capacity: 10 US qts./9 Imp. qts.

Cooling system, hoses and connections

Check all cooling system hoses and connections for defects or deterioration of hoses and loose clamps or fittings.

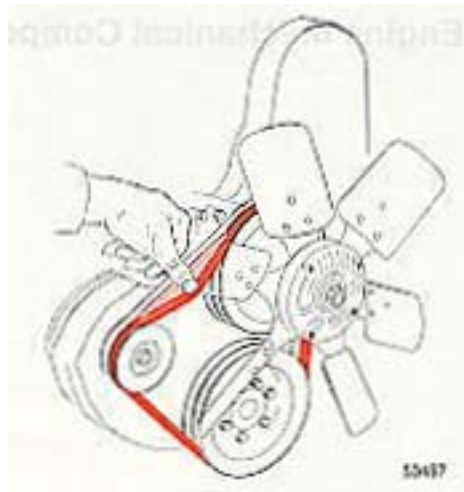

Drive belts

The belt tension can be checked by depressing the fan belt at a point midway between the alternator and fan. It should be possible to press down the belt about 5-10 mm.

This also applies to other drive belts.

pg. 50 Emission Control Systems

I Engine Mechanical Components

which means that the injectors are open and inject fuel as long as the engine is operating. This system has few moving parts, is reliable and copes with the exhaust emission standards. Air supplied to the engine is continuously measured and determines the amount of fuel injected. The air flow is regulated by the throttle. The air flow sensor and the fuel distributor are integrally built as a single unit. A lever is actuated by the air flow to produce continuous fuel distribution.

Fuel

91 octane RON (Research Octane Number) unleaded fuel permitted for all models and **required** for certain models (with catalytic converter).

A label on the instrument panel and on the rear fender, near the filler inlet, will remind of this requirement.

It is unlawful to dispense leaded fuel into a vehicle labeled "unleaded gasoline only".

Special instructions for work on the fuel injection system

Extreme cleanliness is essential when working on the injection system. Great care must be observed. Injection system service should be handled by authorized Volvo dealers, using equipment intended for this service.

Fuel (line) filter

The fuel filter is located on the firewall. This filter is to be changed every 30,000 miles. The filter is replaced as one complete unit.

Filter replacement should be made in a shop.

Fuel (tank) filter

A filter is installed in the suction line in the fuel tank. Its function is to prevent any dirt in the tank from being sucked up to the fuel pump. The filter should be cleaned every 15,000 miles.

Air cleaner

Replace the air cleaner cartridge with a new one every 30,000 miles. The cartridge should be replaced more often when driving under dirty and dusty conditions. No cleaning of any kind is to be made between the above mentioned intervals.

pg. 52 Emission Control Systems

Checking and adjusting idling speed and mixture ratio

These checks should be made every 15,000 miles.

The idling speed should be adjusted at the 600 miles inspection.

Fuel system cap, tank and lines, and connections

The effectiveness of the fuel system to contain hydrocarbons is largely dependent upon a leak-free

system. Check for proper sealing of gasoline filler cap which contains "O" ring type seals. Check all evaporative hoses in vehicle for tightness. Check fuel lines under vehicle and repair if necessary.

Inspection of fuel injection electrical connections

The electrical connections and fuel lines in the injection system should be checked for chafing and corrosion every 15,000 miles.

III Engine Ignition Components

Change spark plugs

The spark plugs should be changed every 15,000 miles.

However, city driving or fast highway cruising require changing after 7,500 miles of driving. Tightening should be done with a torque wrench. When fitting new plugs, be sure to fit the right type: Volvo no 273545 (Bosch W 175 T 30 or corresponding).

When changing the plugs, check that the suppressor connectors are in good condition. Cracked or damaged connectors should be replaced.

When changing spark plugs, clean the cables and cable terminals, also the rubber seals. If the car is driven on roads where salt is placed to counteract skidding, spray the cables with silicone spray.

Ignition timing

Distributor advance mechanism

The ignition timing should be adjusted every 15,000 miles. All adjusting work should be done with the proper equipment. The distributor is one of the most sensitive units in the engine and careless handling can lead to decreased engine output and high fuel consumption or even serious damage to the engine.

The distributor advance mechanism should be checked every 30,000 miles.

Ignition wiring

The ignition wiring system is composed of primary and secondary systems. The secondary systems are the high tension leads connecting the distributor cap with the spark plugs and the coil.

These wires should be inspected at each engine tune-up, and should be replaced if cracked, frayed or damaged from abrasion. It is important to clean all parts of this secondary system thoroughly because dirt greatly reduces the available voltage to the spark plugs.

Distributor cap and rotor

Check the distributor cap and rotor for cracks, carbon formation, dirt and erosion.

IV Engine Crankcase Ventilation System

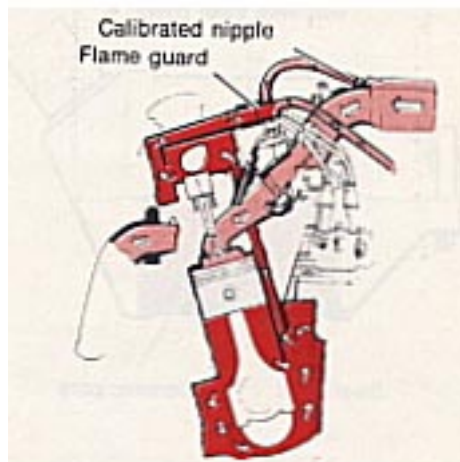

Crankcase ventilation

The engine is provided with positive crankcase ventilation which prevents crankcase gases from being released into the atmosphere.

Instead, the crankcase gases are admitted to the intake manifold and cylinders.

Cleaning PCV valve

The calibrated positive crankcase ventilation valve should be removed and cleaned every 15,000 miles. Rubber hoses and flame guard should be checked for damage at the same time. Replace if necessary.

V Engine External Exhaust Emissions

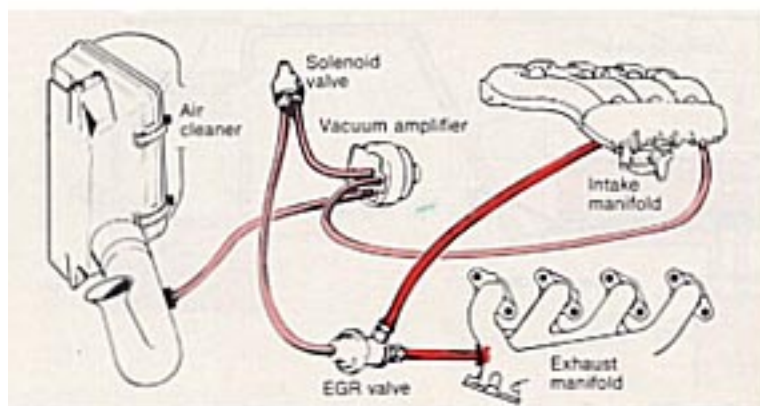

Exhaust Gas Recirculation Components

Clean EGR valve, pipe, manifold nipple every 15,000 miles.

Replace EGR valve every 30,000 miles.

To remind the driver about the EGR service, there is a special EGR service reminder light (see [page 7](#))

which comes on at 15,000 miles intervals.

This is a reminder to get the EGR valve serviced. The light will stay on until reset.

pg. 54 Emission Control Systems

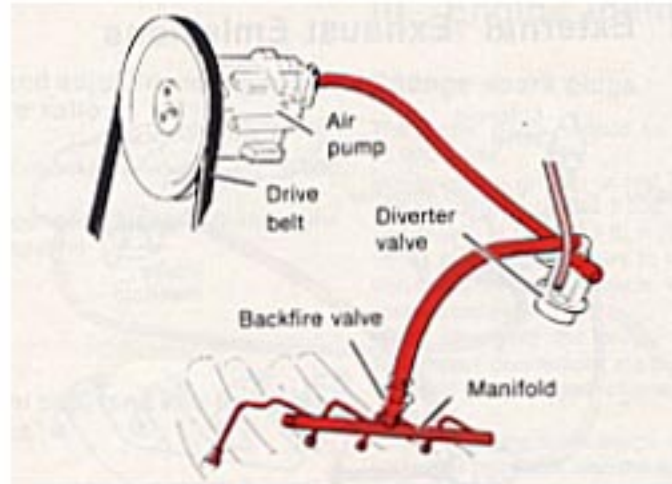

Air Injection Reactor System

This system admits fresh air to the hot exhaust gases in the exhaust manifold. The fresh air will burn the unburned portion of the exhaust gases to reduce hydrocarbon and carbon monoxide contents.

The air pump is located on the right side of the engine and driven by a belt.

The air is drawn into the air pump via an air filter. The compressed air is fed out of the pump through the diverter valve. This valve has two functions. It regulates the air pump pressure. It also shuts off the air delivery when using the engine to brake. If the system was allowed to operate under this condition, fresh air mixed with the overly rich vapor would cause a backfire.

The backfire valve admits air into the exhaust manifold but prevents return of exhaust gas to the air pump incase of a backfire or air pump malfunction, such as drive belt damage.

Air Injection Reactor check

This system should be checked every 15,000 miles. Hoses and connections should be checked for leaks and condition. Check the diverter valve and backfire valve operation. Check the operation of the air pump and that there is no excessive noise.

The exhaust emissions will be incorrect if the AIR System does not operate properly.

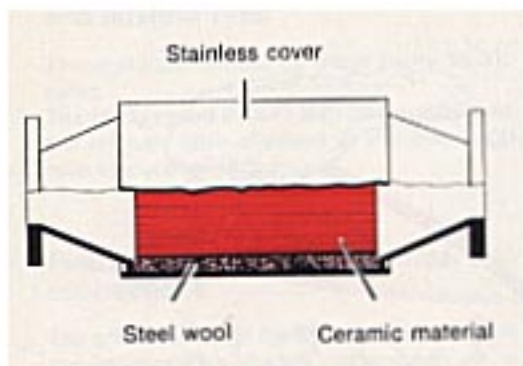

Catalytic Converter

This is a supplementary device in the exhaust system, designed to clean the remaining dirty exhaust gases.

This device is mainly a container with a ceramic material insert, designed to let the exhaust gases pass through channels in the insert. The channel walls are covered by a thin layer of platina-palladium. These metals act as catalysts, permitting a chemical process without actually taking part in it.

The CO content will increase if the Catalytic Converter is damaged.

pg. 55 Emission Control Systems

NOTE:

Vehicles with Catalytic Converter must use unleaded fuel only. Otherwise the Catalytic Converter will be destroyed.

Torque catalytic converter mounting bolts (certain models)

The catalytic converter mounting bolts should be torqued every 15,000 miles.

VI Engine Evaporative Emissions

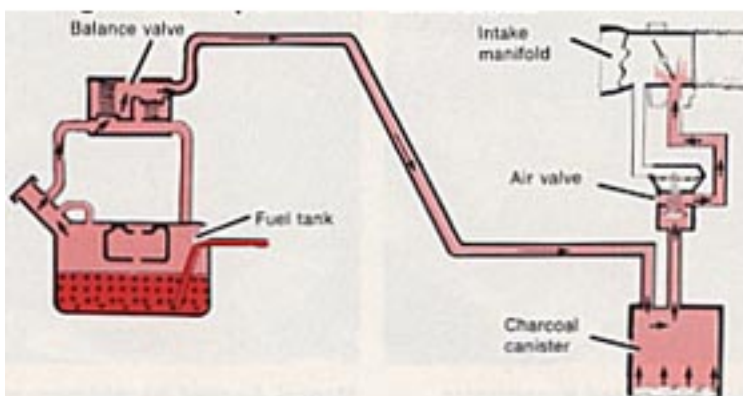

Evaporative Control Systems

Vehicles intended for the North American market are equipped with a gas evaporative control system, which prevents gas fumes from being released into the atmosphere.

The system comprises an expansion tank in the fuel tank, a check valve at the fuel tank and a charcoal filter in the engine compartment. The components are interconnected by hoses which convey fuel fumes from the gas tank to the charcoal filter where they are stored until the engine is started and then drawn into the engine.

Evaporative Control Canister

Replace the filter every 45,000 miles.



[Contents](#) | [Top of Page](#)



Manual transmission

A=level and filler plug

B=drain plug

The oil level should be up to the filler plug.

Top up with transmission oil SAE 80W/90 or SAE 80/90.

Drain the oil immediately after driving, while it is still hot.

Capacity: 0.8 US qts = 0.75 liters



Transmission with overdrive

A=level and filler plug

B=drain plug

See picture above.

The oil level should be up to the filler plug.

Transmission as well as the overdrive are lubricated by the same oil.

When draining, remove the drain plug. Also remove the cover for the overdrive strainer and clean the strainer.

Use transmission oil SAE 80W/90 or SAE 80/90.

Capacity: 2.4 US qts = 2.3 liters

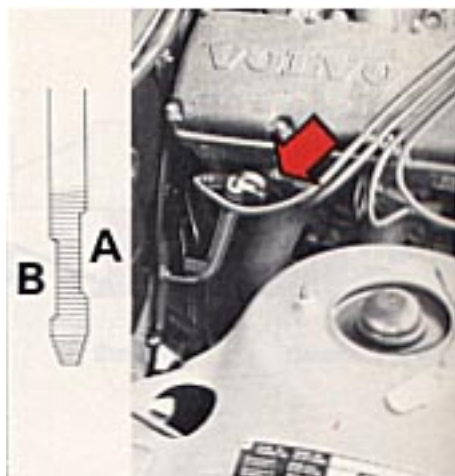

Automatic transmission

When checking oil level, park the vehicle on level ground with the engine idling. Move the gear selector slowly between all shift positions. Select position P, wait 2 minutes and check the oil level.

NOTE: The dipstick has graduations for hot (A) and cold (B) transmission oil.

Wipe the dipstick with a clean nylon rag or paper towel.

When necessary, top up with Automatic Transmission Fluid type F (FLM). Fill through the dipstick tube.

See also [page 44, note 1](#).

pg. 57 Rear axle, power steering, brake fluid



Rear axle oil

A=level and filler plug

B=drain plug

The oil level should be up to the filler plug.

When necessary, top up with rear axle oil, API GL-5 (MIL-L-2105 B), SAE 90 (SAE 80 W when the temperature is steadily below 15° F= -10° C). Cars equipped with limited slip differentials should use oils with proper additives.

The oil is changed at the 600 mile service inspection only.

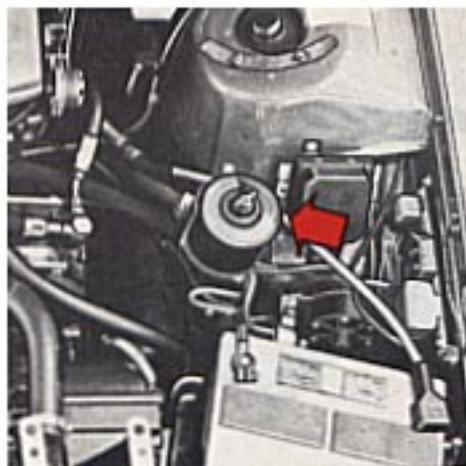

Power steering

Wipe the reservoir clean.

Check fluid level while the engine is idling.

The level should be at the level mark on the inside of the container.

The fluid level will rise when the engine is stopped. No fluid changes necessary.

When necessary, top up with Automatic Transmission Fluid.



Brake fluid

Each time you refill with gasoline, check that the brake fluid level exceeds the MIN mark.

When necessary, top up with brake fluid according to specifications DOT 3 or DOT 4 (SAE J 1703).

The brake fluid should normally be changed every third year or 45,000 miles.
 (Change brake fluid every year when driving under extremely hard conditions: mountain driving etc.)

pg. 58 Lubrication

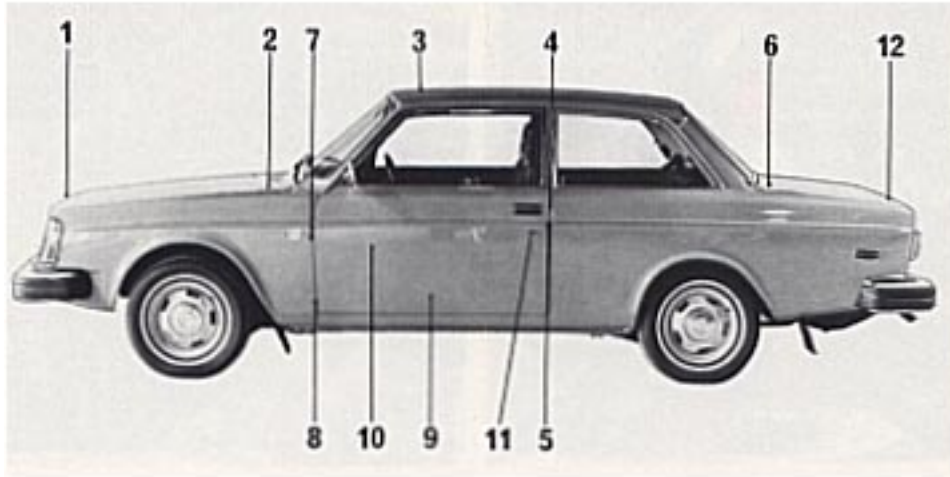

Chassis maintenance

To simplify maintenance of your Volvo, the vehicle has been equipped with ball joints, steering rods and propeller shafts that do not require regular lubrication.

To avoid rattles and unnecessary wear, the body should be lubricated once a year. The hinges on hood, doors and trunk lid as well as door stops should be lubricated every 7,500 miles. During the wintertime, the locks in the doors and trunk lid should be treated with special anti-freeze lubricant to prevent them from freezing up.

Door Hinges and door stop

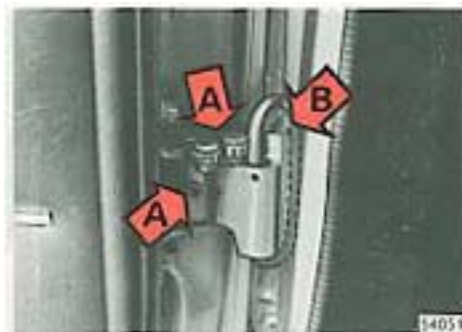

A. grease B. oil

No. Lubricating point

- 1 Hood lock
- 2 Hood hinges

Lubricant

- Paraffin wax
- Oil

3 Sun-roof wind deflector	Oil
4 Door lock outer sliding surfaces	Paraffin wax
5 Striker Plate	Paraffin wax
6 Trunk lid hinges	Oil
7 Door hinges	Grease
8 Door hinges	Grease
Door stop	Oil
9 Front seat slide rails and latch devices	Paraffin Wax, oil Silicon grease
10 Window regulator	Oil, Grease
Locking device (Accessible after door upholstery panels removed)	Silicone grease
11 Key holes	Lock oil
12 Trunk lid lock	Lock oil

pg. 59 Coolant

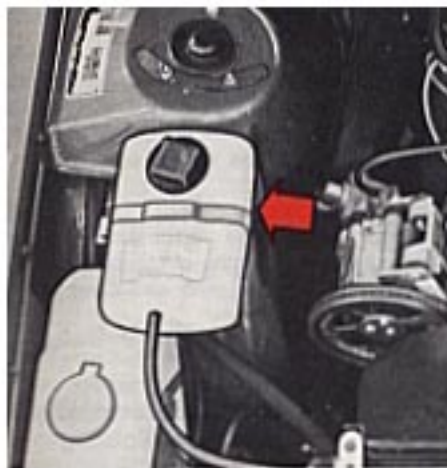

Check coolant level

The cooling system must be filled with coolant and not leak if it is to operate at maximum efficiency. Check the coolant level when filling up with fuel. The level should be between the "MAX" and "MIN" marks on the expansion tank. The check should be made with particular thoroughness when the engine is new or the cooling system has been drained.

Do not remove the filler cap other than for topping-up with coolant. Frequent removal may prevent coolant circulation between the engine and the expansion tank during engine warming up and cooling.

Top up with coolant

Top up with coolant by filling the expansion tank when level is at the "MIN" mark. Use a mixture of 50 percent anti-freeze/summer coolant and 50 percent water all the year round. Top up to the "MAX" mark.

NOTE: Do not top up with water only. Water by itself reduces both the rust-protective and anti-freeze qualities of the coolant. It can also cause damage to the cooling system if ice should form in the expansion tank.

NOTE: In warm climates where there is little risk of frost, water can be used without anti-freeze. We recommend, however, to add a rust inhibitor.

pg. 60 Note, Replacing bulbs

This car is equipped with an alternator

When changing the battery or when carrying out work involving the electrical system, the following should be observed:

- 1 A battery connection to the wrong terminal will damage the diodes. Before connections are made, check the polarity of the battery with a voltmeter.
- 2 If booster batteries are used for starting, they must be properly connected to prevent the diodes from being damaged.
The ground lead from the booster battery must be connected to the ground terminal of the car battery and the positive lead from the booster battery to the positive terminal.
- 3 If a fast charger is used for charging the battery, the battery leads should be disconnected.
- 4 Never disconnect the battery circuit (for example, to change the battery) while the engine is running, as this will immediately ruin the alternator.
Always make sure that all the battery connections are properly tightened.
- 5 If any electrical welding work is performed on the vehicle, the ground lead and all the connecting cables of the alternator must be disconnected and the welder wires placed as near the welding point as possible.

Replacing bulbs

The replacement of bulbs in the various lighting units is shown on the following pages. Make sure when installing bulbs, that the guide pin on the socket fits into its corresponding recess.

When installing bulbs, do not touch the glass with your fingers. The reason for this is that grease, oil or any other impurities can be carbonized onto the bulb and damage the reflector.

Replacing bulbs for instrument lighting and heater control lighting

Due to the location of these bulbs, their replacement should be carried out by a Volvo dealer.

Replacing bulbs for rear side marker lights

Remove the two Phillips screws which hold the lens. The bulb can now be removed by pressing it inwards and turning it slightly counterclockwise.

pg. 61 Replacing bulbs

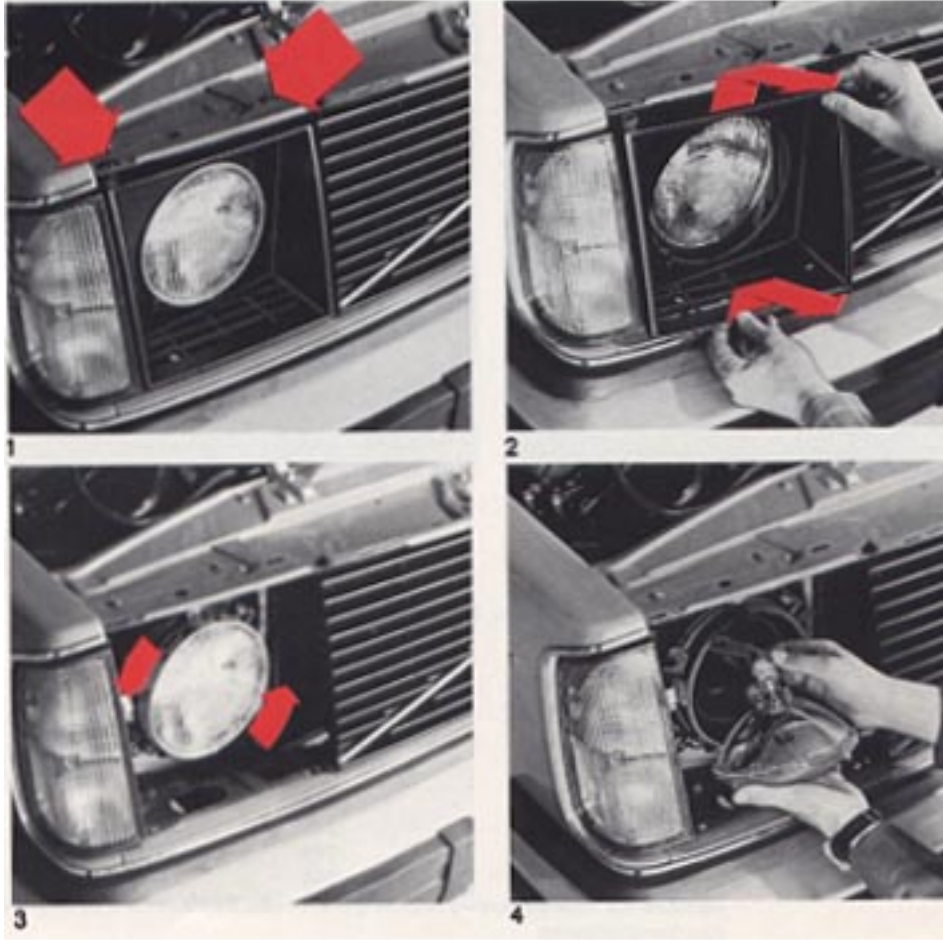

Replacing sealed beam headlamp units

1. Press the two plastic screws down and turn them 1/4 turn and remove them.
2. Lift up the rim slightly and remove it forwards.
3. Turn the chromed ring slightly counterclockwise. Remove the chromed ring and lift out the headlamp unit.
4. Disconnect the socket contact.

Installation is done in the opposite way. Check that chromed ring is retained by all four clips.

Check headlight alignment.

pg. 62 Replacing bulbs

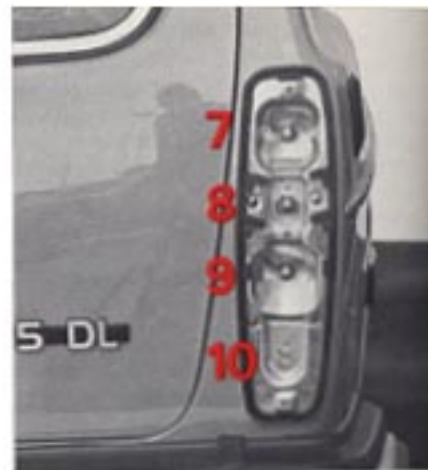
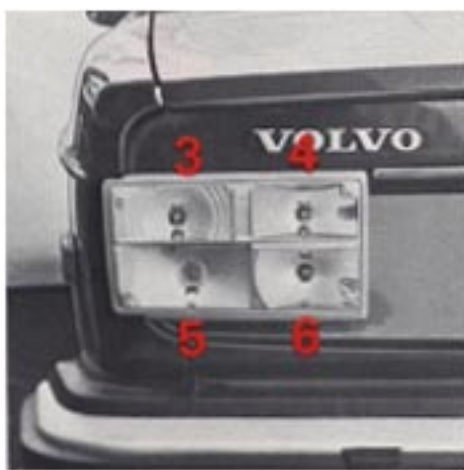
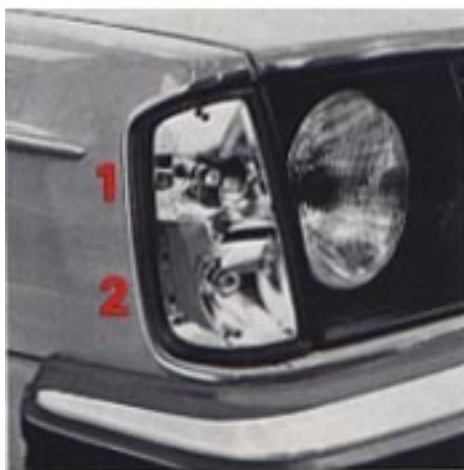

		Power W/cp	Socket	US bulb No
1 Front position, side marker light	242, 244, 245	5/4	Ba 15 s	67
2 Front turn signal	242, 244, 245	21/32	Ba 15 s	1073
3 Rear turn signal	242, 244	21/32	Ba 15 s	1073
4 Back-up light	242, 244	21/32	Ba 15 s	1073
5 Tail light	242, 244	5/4	Ba 15 s	67
6 Stop light	242, 244	21/32	Ba 15 s	1073
7 Rear turn signal	245	21/32	Ba 15 s	1073
8 Back-up light	245	21/32	Ba 15 s	1073
9 Stop light	245	21/32	Ba 15 s	1073
10 Tail light	245	5/4	Ba 15 s	67

Remove the Phillips screws retaining the lenses. Replace bulb by slightly depressing and turning counterclockwise.

pg. 63 Replacing bulbs



License plate light

Insert a screwdriver through the opening in the housing and depress the catch tab.
Pull out the housing assembly.

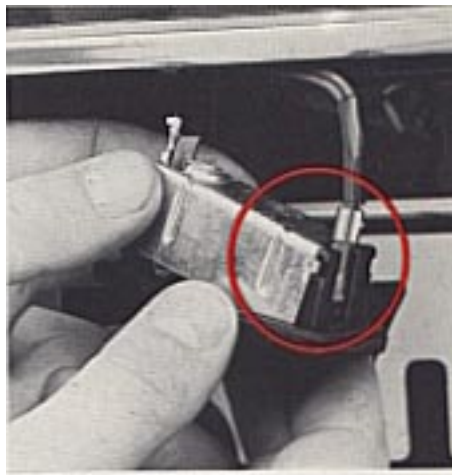

Pull out the cover end which is not provided with a lock pin.

Replace bulb.

When re-installing, first locate the lock pins (see picture) and then press on the cover.

Check that the rubber gasket is positioned and press the housing assembly into place.



Interior light

Insert a screwdriver through the opening in the right side of the housing and depress the catch tab. Pull down the housing assembly and replace the bulb.

pg. 64 Fuses



Replacing fuses

The fuse box is positioned in front of the front left door pillar.

The cover is removed by turning the small knob at the bottom a 1/4 turn.

When replacing fuses, check that right amperage is used.

Never use fuses of higher amperage. If one fuse often melts, take the car to your Volvo dealer for fault-tracing.

Reading downwards the fuses protect the following:

1 Lighter, Rear wiper/washer	8 A
2 Windshield wiper/washer, Heater fan, Horn	16A
3 Rear demist, Overdrive	16A
4 Glove compartment light, Back up lights, (El. heated seat), Air conditioning	8A
5 Instrument, Turn signals, Warning lights, Relay, fuel injection system, (Seat belt warning)	8A
6 Hazard, Engine compartment light	8A
7 Clock, Fuel pump	8A
8 Stop lights, interior light	8A
9 Spare	8A
10 Spare	8A

11 Left parking and side marker, (Rear fog lights)	8A
12 Right parking and side marker lights, Instrument and panel lights	8A

pg. 65 Wheels and tires

General

The car is equipped with pressed steel wheels.

If possible, the wheels should always be used on the same side throughout their lifetime. This is particularly important for studded winter tires, otherwise the studs may loosen and come off.

Snow tires

Studded snow tires should also have a running-in period of between 300-600 miles (500-1,000 km). During this period try to avoid driving hard round bends and at high speeds, also hard braking and acceleration. Radial type tires, with or without studs are recommended for winter use.

Tire **chains** can be used on the rear wheels only providing that the chains are **finelinked** and do not project so much from the tire that they can rub against the brake caliper or other components.

Strap-on emergency chains must not be used since the space between the brake calipers and the wheel rims does not allow sufficient clearance.

Check tire wear pattern

Check the tires at regular intervals for damage and abnormal wear, also for particles which can fasten in the tread. Have them balanced if necessary. Poorly balanced wheels will rapidly increase the wear on the tires and affect riding comfort.

Tire wear indicator

The tires have a so-called "wear indicator" in the form of a number of narrow strips running across or parallel to the tread. When about 1/16" (1.5 mm) is left on the tread, these strips show up and warn the car owner that the tire is ready to be replaced.

Check tire pressure

Check the tire pressure regularly when refueling. See [page 85](#) for the correct tire pressure. Do not forget the spare wheel when checking the pressure.

When driving, the tire temperature and pressure rises in relation to the speed of the vehicle and its load.

Normally the pressure should only be checked when the tires are cold. When the tires are warm, a change in pressure should take place only when air must be added into the tires.

Excessively low tire pressure is one of the most common reasons for tire wear. Tires which are insufficiently inflated will increase the required steering effort and cause higher fuel consumption. Too high air pressure tends to make traveling less comfortable.

pg. 66 Wheel changing



Changing a wheel

The spare wheel, jack and tool kit are stowed in the trunk compartment. When the car is to be raised up, the jack should be on level, firm ground.

Avoid creeping under the car when it is raised by the jack. There is a risk that the car may slide off the jack, especially if the ground is soft.

Before the vehicle is raised up, the parking brake should be applied and one of the gears engaged. Also block one of the wheels standing on the ground.



Removing

Remove the wheel cap with the screwdriver provided in the tool kit.

Loosen the wheel nuts 1/2-1 turn with the help of the box spanner. All of the wheel nuts have right hand

threads which can be loosened by turning the wrench counterclockwise.



Insert the lifting arm of the jack into the appropriate jack attachment next to the wheel to be changed.

pg. 67 Wheel changing

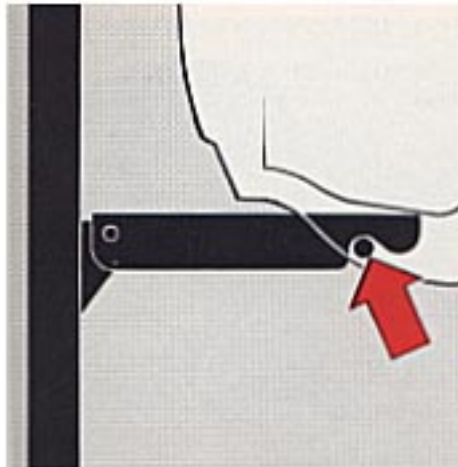

Make sure the arm goes in all the way.

Raise up the side of the car high enough to lift the wheel off the ground.

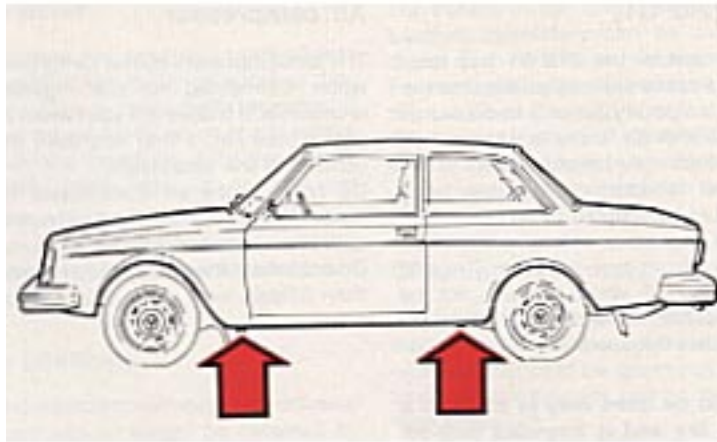

Unscrew the wheel nuts completely and remove the wheel. Be careful when removing the wheel that the stud threads are not damaged.

Installation

- Clean the contact surface between wheel and hub.
- Install the wheel.
- Tighten the nuts until the wheel makes good contact with the flange.
- Lower the vehicle and tighten the nuts alternately. (Tightening torque: 72-100 ft. lbs.)
- Fit the wheel cap.

Do not rotate the raised wheel if the car is equipped with a limited slip differential as this will also move the other rear wheel on the ground and the car may slide off the jack.



[Contents](#) | [Top of Page](#)

Washing

The car should be washed at regular intervals since dirt, dust, insects and tar spots adhere to the paint and may cause damage. During the winter, special care should be observed to wash off all road salt residue as soon as possible in order to prevent corrosion.

When washing the car, do not expose it to direct sunlight. Soften up the dirt on the underside with a water hose. Then rinse the entire body with a light spray until the dirt has loosened. Wash the dirt off with a sponge, using plenty of water. Use preferably luke-warm water.

A detergent can be used to facilitate washing.

Special detergents are now available on the market - even household detergent can be used.

A water soluble grease solvent may be used in cases of sticky dirt. However, use a washplace equipped with a drainage separator.

A suitable mixture is about 1 1/2 - 3 1/2 fl. oz. (5-10 cl) of fluid dish washer to 2.6 US gals. =2.2 Imp. gals (10 liters) of water. Asphalt spots and tar pittings can easily be removed with kerosene or Tar Removers but this should be done after washing. When a detergent is used, the car should be rinsed with clean water.

Then dry carefully with a soft clean chamois cloth. Use a separate chamois cloth for windows. Using the same chamois cloth can cause greasy smears on the windows. When washing the car, remember to clean the drain holes in doors and bottom rails.

Chromed parts

Chromium-plated and anodized parts should be washed with clean water as soon as they become dirty. This is particularly important if you drive on gravel roads which are treated with chemicals to keep the dust down or in the winter when salt is used to melt the snow. After the car has been washed, apply wax or an anti-rust preparation.

Stains on chrome trim can be removed with commercially available chrome cleaner. Do not use abrasive compounds or steel wool.

Polishing (waxing)

Polishing and waxing are not necessary unless a glossy surface can no longer be obtained by normal car washing.

Normally, polishing is not required during the first year after delivery, however, waxing may be beneficial.

Before applying polish or wax the car must be washed and dried. Tar spots can be removed with kerosene or tar remover. Difficult spots may require a fine rubbing compound.

After polishing use liquid or paste wax.

Several commercially available products contain both polish and wax. Waxing alone does not substitute for polishing of a dull surface.

pg. 69 Cleaning

Cleaning the upholstery

The upholstery in your Volvo is a combination of fabric and plastic or leather and plastic.

Generally the **fabric** can be cleaned with soapy water or a detergent. For more difficult spots caused by oil, ice cream, shoe polish, grease, etc. Use a stain remover.

The **Plastic** in the upholstery can be washed with a mild detergent or in more difficult cases with a household detergent.

Leather upholstery can be cleaned with a damp cloth, eventually with a mild soap solution.

For more difficult spots, consult an expert for the choice of cleaning agent.

On no account must gasoline, naphtha or similar cleaning agents be used on the plastic or the leather since these can cause damage the plastic and leather.

Cleaning floor mats

The floor mats should be vacuumed or brushed clean regularly, especially during the winter when they should be taken out for drying.

Spots on textile mats can be removed with a mild detergent.

Rubber mats can be washed with methylated spirit which must be subsequently washed off with water.

Anti-rust treatment

Your Volvo has been rust protected at the factory. On external surfaces a heavy coat of wear resistant material has been used, while on the internal surfaces a lighter rust protector is used.

The exterior rust protection should be inspected regularly or at least once per year. If the rust protection has been penetrated a repair should be made as soon as possible to prevent moisture from creeping between the metal and coating. Carefully clean and remove any rust prior to repair of the rust protective coating.

The internal rust protection should normally be renewed after three years and every two years thereafter.

pg. 70 Paint touch-up

Paint touch-up

Paint damage requires immediate attention to avoid rusting. Make it a habit to check the finish regularly and touch-up if necessary, for instance when washing the car.

Paint repairs require special equipment and skill and you should contact your Volvo dealer for any extensive damages.

Minor scratches can be repaired by using Volvo touch-up paint.

Note: Use the paint code which you will find on the Vehicle Designation plate on the wheel housing when ordering touch-up paint from your Volvo dealer.



Minor stone chips and scratches

Material:

Primer - brush on type

Surface finish - brush on type

(The paint pen head also contains grinding paste for subsequent treatment.)

Penknife or similar

Brush

Note: When touching-up, the car should be well cleaned and dry and have a temperature above +15°C (60°F).

Scratches on the surface where the paint has not been completely penetrated, can be repaired directly after light scraping to remove dirt.

Deep scratches down to the bare metal:

1 Scrape or sand the damaged surface lightly and break the edges of the scar.



2 Apply the rust remover. (watch eyes and skin!), wait a few minutes and then rinse carefully with water.

3 Thoroughly mix the primer and apply it with small brush or a match.



- 4 When the primed surface is dry, the paint can be applied by a brush.
Mix the paint thoroughly, apply several thin paint coats and let flush after each application.

pg. 71 Paint touch-up



- 5 If there is a longer scratch, you may want to mask to protect surrounding paint.

Touching-up flaking fender edges and sills

Material:

Primer - spray

Surface finish - spray

Sand paper (H 150 - 300 grit)

Thinner

Note: When touching-up the car, it should be well cleaned and dry and have a temperature exceeding +15°C(60°F).

Mask with tape and paper prior to painting larger surfaces. Remove the masking immediately after application of the last paint coat, before the paint starts to dry.

Touching-up is as follows:

1 Remove paint flakes.

2 Sand the damaged surface and wash it clean with thinner.

Apply the rust remover. (watch eyes and skin!), wait a few minutes and then rinse carefully with water.

3 Shake the spray can for at least 1 minute. Spray on the primer. Move the can slowly and evenly forwards and backwards over the spot and about 20-30 cm (8-12 in.) from the surface. Protect the surrounding surfaces with suitable paper.

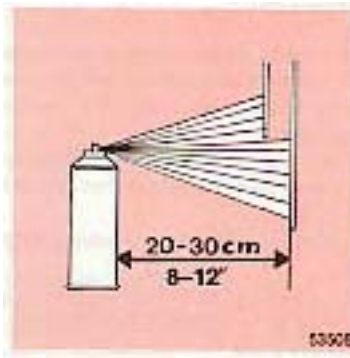

4 When the primer has dried apply the surface enamel in the same way. Spray on several times and allow the paint to dry a minute or so between each application.

pg. 72 Long distance trips

Before a long distance trip

Have your car checked at a Volvo dealer. Preventive maintenance will alleviate undue breakdown. Take along a Volvo dealer directory.

The main items to check are listed below:

1. Brakes, front wheel alignment and steering gear.
2. The engine running condition.
3. Fuel system operation.
4. Oil levels.
5. Cooling system. Check for leaks or doubtful hoses.
6. Tires. Replace worn tires.
7. Battery. Clean terminals.
8. Tool equipment.
9. Lighting.
10. Drive belts for tightness and wear.

pg. 73 Cold weather

During the fall have your Volvo dealer winterize your car.

Engine cooling system

A good quality anti-freeze/summer coolant should be used all the year round. Thus, the cooling system should always contain water plus anti-freeze and rust inhibitor, even during the summer. Experience has also shown that extremely weak anti-freeze solutions (10-25 percent) are very unfavorable from the point of view of rust protection. For this reason, the quantity of anti-freeze/summer coolant should amount to about 50 percent of the solution, that is 5.0 qts. = 4.3 Imp qts = 4.8 liters, this lowers the freezing point to -31°F (-35°C).

Alcohol must not be used as an anti-freeze agent since it evaporates at normal engine temperature.

Engine fuel system

During the wintertime with large variations in temperature, condensation forms in the fuel tank and can impair the running of the engine. This can be eliminated by adding special additives to the fuel. There is less risk of condensation forming in the fuel tank if it is kept full.

Engine lubricating system

During the winter, multigrade oil 10W-40 should be used in the engine. At very low temperatures (below 0° F), multigrade oil SAE 5W-20 is recommended. These oils reach the lubricating points in the engine more easily at low temperature and also facilitate cold starting. See [page 48](#).

Electrical system

The electrical system in the vehicle is subject to great stresses during the winter than during the warm summer months, because the electrical equipment and starter motor are used more often. Since the capacity of the battery is also considerably lower at low air temperature, the state of the charge must be checked more often and, if necessary, the battery charged. If the battery voltage is excessively low, there is a risk of the battery being damaged by frost.

Brake system

During cold weather the brakes are subject to splash and condensation which can result in the parking brake freezing up if applied for long periods of time. Use of first or reverse gear on a manual transmission or position "P" on an automatic transmission is preferable during these conditions. See [page 39](#).

Windshield washers

Just as anti-freeze is added to the cooling system during the winter to prevent frost damage, anti-freeze should also be added to the water container for the windshield (rear window) washer. This is particularly important during the winter because the windshield frequently becomes dirty and is often splashed with water which rapidly freezes and thus necessitates the frequent use of the windshield washer and wipers. Your Volvo dealer can supply you with suitable anti-freeze for this purpose.

Anti-freeze for door locks

Lubricate the outside locks with a suitable anti-freeze. Such agents are commercially available and should be used before the first frost.

pg. 74

This page left intentionally blank.

pg. 75 Service diagnosis

The diagnosis outlined below is only intended to serve as a guide to locate and temporarily correct minor faults. Causes of unsatisfactory performance should be investigated and corrected by your Volvo dealer.

NOTE: The points indicated by an asterisk (*) should be checked by your Volvo dealer.

Condition: Starter fails to operate (or operates very slowly)

Possible cause	Correction
Weak battery or dead cell.	With the ignition switch in the "Driving" or "On" position, check to see if the warning lights on the dashboard come on and if they go off when the starter is engaged. If the lights do not come on or if they go out when the starter is engaged, the battery is discharged or see below.
Loose or corroded battery cable terminals.	Check battery terminals and clamps, clean or replace if necessary. Check that the starter cable is tightened. The ground strap, which connects the body to the rear of the engine, should also be checked for corrosion and looseness.
Open circuit between ignition/starter switch and ignition terminal on starter.	The circuit is closed if a clicking sound is heard from the starter when it is engaged. If no clicking sound is heard, check that the blue wire at the starter is tightened. If still no clicking sound is heard, the ignition switch or the wire is defective.
Starter motor defective.	If the above checks have been performed, and no fault is evident, the starter may be defective.
	NOTE: In this case the headlight intensity will not dim when the starter is engaged.

pg. 76 Service diagnosis

Condition: Starter motor operates but engine does not start

Possible cause	Correction
Intake system leaking.	Check that the flexible air intake hose, connecting the air cleaner and intake manifold is tight and not damaged.

No fuel reaching engine.	Check for fuel in the tank. Check fuses No 7.
No spark.	Remove one spark plug wire and unscrew the radio interference suppressor. Hold the wire approx. 3/8" from the valve cover and run the starter. If there is no spark, check: that the high tension lead from the coil to the distributor cap is connected and that the wires to the distributor and coil are connected.
Spark plugs, high tension leads or distributor cap worn (defective).	Clean the parts with a dry cloth or spray with a moisture remover.
Cold start injector out of order.	Test the cold start injector function with cold and hot engine.*
Rest pressure incorrect.	Test rest pressure and the fuel system for leaks.*
	If no fault is found, according to the above, see a Volvo dealer.

pg. 77 Service diagnosis

Condition: Erratic idle (misfiring)

Possible cause	Correction
Intake system leaking.	Check that the flexible air intake hose, connecting the air cleaner and intake manifold is tight and not damaged.
Exhaust Gas Recirculation Valve leaking.	Test the valve function.*
Spark plugs, high tension leads or distributor cap worn (defective)	Clean cap and leads, check the cap for cracks.
Worn spark plugs.	Remove, clean or replace spark plugs.
Cold start injector leaking.	Test the injector function.*
Uneven compression.	Test compression.*

Condition: Engine stalls at irregular intervals

Possible cause	Correction

Defective wires.	Check wire terminals at: fuel pump, fuse No. 7, coil, distributor, ignition switch, relays and air flow sensor.
Intake system leaking.	Check that the flexible air intake hose, connecting the air cleaner and intake manifold is tight.
Low idle.	Adjust.*
Fuel filter clogged.	Clean fuel tank filter and replace line fuel filter.
Exhaust Gas Recirculation Valve seizing.	Replace valve.* (Engine will die at idle.)

pg. 78 Service diagnosis

Condition: Low top speed, loss of power

Possible cause	Correction
Air filter clogged.	Check air filter.*
Throttle misadjusted.	Check that the throttle touches the high speed stop when the accelerator is fully depressed.*
Fuel filter clogged.	Clean fuel tank filter and replace fuel line filter.*
Incorrect timing or dwell angle.	Check and adjust.*

Condition: Excessive fuel consumption

Possible cause	Correction
Fuel lines leaking.	Check tightness.
Spark plugs worn.	Replace plugs.
Incorrect timing.	Check/adjust.*
Air filter clogged.	Check/replace.*
Control pressure incorrect.	Check/replace control pressure regulator.*
Cold start injector leaking.	Replace injector.* (A leaking cold start injector also causes uneven idle and hard starting.)

pg. 79 Service diagnosis

Condition: Dieseling

Possible cause	Correction
Injector leaking.	Check air flow sensor plate and rest pressure.*

Condition: Misfiring at highway driving speed

Possible cause	Correction
Spark plugs fouled.	Drive the vehicle in a lower gear and keep the engine rpm higher for a few miles in order to remove carbon deposit on the spark plugs. If this procedure is not effective, clean or replace the spark plugs if necessary.

Condition: Deceleration backfiring

Possible cause	Correction
Diverter valve faulty.	Check diverter valve operation.*

pg. 80 Specifications

Type designations

In all correspondence concerning your vehicle with the dealer and when ordering parts, the V.I.N number should always be quoted.

1 V.I.N. (Vehicle Identification Number)

V.I.N. plate is located on the body on the left windshield pillar. The V.I.N. is also stamped on the right hand door pillar.

2 Vehicle Emission Control Information

Your Volvo has been built to comply with all North American safety and anti-pollution regulations and evidence of this can be verified from the certification labels on the left wheel housing. For further information regarding these regulations, please consult your Volvo dealer.

3 Model Plate

Vehicle type designation, code number for paint color and upholstery: on wheel housing.

4 Loads and Tire Pressures

5 FMVSS specifications

These two labels are located on the left front door opening.

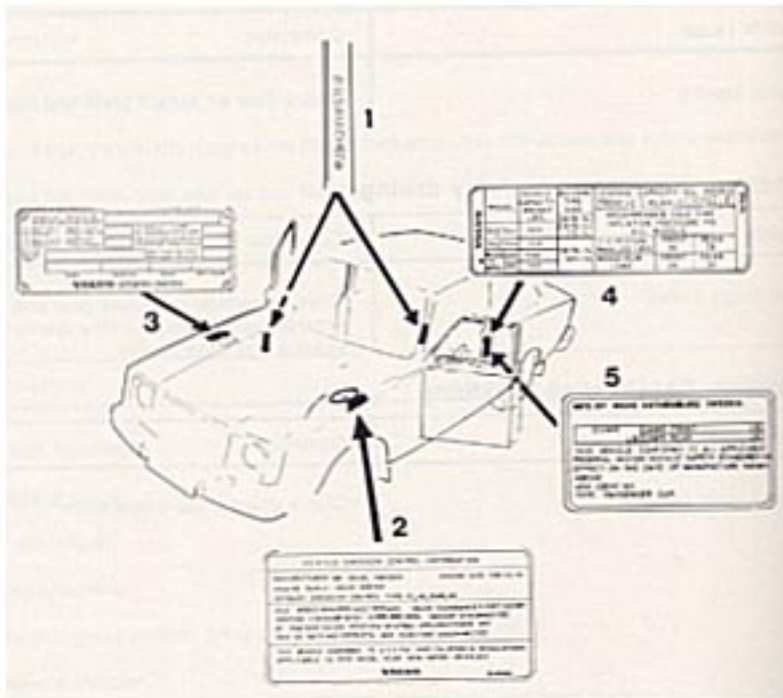

[Contents](#) | [Top of Page](#)

1 9 7 6 VOLVO 242, 244, 245

pg. 81 Specifications

Dimensions and weights	242	244	245
Length	192.6" (489 cm)	192.6" (489 cm)	192.6" (489 cm)
Width	67.3" (171 cm)	67.3" (171 cm)	67.3" (171 cm)
Height, curb weight	56.5" (144 cm)	56.5" (144 cm)	57.5" (146 cm)
Wheelbase	104.0" (264 cm)	104.0" (264 cm)	104.0" (264 cm)
Ground clearance (full load)	4.9" (12.5 cm)	4.9" (12.5 cm)	
Track, front	55.9" (142 cm)	55.9" (142 cm)	55.9" (142 cm)
Track, rear	53.1" (135 cm)	53.1" (135 cm)	53.1" (135 cm)
Turning circle (between curbs)	32.5' (9.8 m)	32.5' (9.8 m)	32.5' (9.8 m)
Curb weight (depending on type)	2844-3060 lbs (1291-1389 kg)	2886-3106 lbs (1310-1410 kg)	3071-3271 lbs (1394-1485 kg)
Gross vehicle weight (GVW)	4030 lbs (1830 kg)	4030 lbs (1830 kg)	4300 lbs (1950 kg)
Capacity weight	920 lbs (420 kg)	920 lbs (420 kg)	1120 lbs (520 kg)
Permissible axle weight, front	1885 lbs (855 kg)	1885 lbs (855 kg)	1885 lbs (855 kg)
Permissible axle weight, rear	2180 lbs (990 kg)	2180 lbs (990 kg)	2600 lbs (1180 kg)
Max. trailer weight	2000 lbs (908 kg)	2000 lbs (908 kg)	2000 lbs (908 kg)
Max. hitch load	160-200 lbs. (75-90 kg)	160-200 lbs. (75-90 kg)	160-200 lbs. (75-90 kg)

Cargo Space	245
Length with rear seat up	44.5" (113 cm)
Length with rear seat down	74.0" (188 cm)
Maximum width	52.4" (133 cm)

Height	33.0" (84 cm)
Volume with rear seat up	53 cu. ft. (1.5 m ³)
Volume with rear seat down	67 cu. ft. (1.9 m ³)
Cargo opening, maximum width	45.7" (116 cm)
Cargo opening, maximum height	30.7" (78 cm)

Capacities

Fuel tank	15.8 US gals/13.2 Imp. gals. 60 liters
Cooling system	10 US qts/8.5 Imp. qts 9.5 liters (of which expansion tank = 1 US qts/0.5 Imp. qt. (0.6 liter))
Oil capacity:	
- engine, oil change	3.5 US qts/3.0 Imp. qts. (3.35 liters)
- engine, incl. oil filter	4.0 US qts/3.4 Imp. qts. (3.85 liters)
transmission(M45)	0.8 US qts /0.7 Imp. qts. (0.75 liters)
(M46)	2.4 US qts/2.2 Imp. qts. (2.3 liters)
(BW 55)	5.9 US qts/4.9 Imp. qts. (5.5 liters)
rear axle	1.4 US qts/1.2 Imp. qts. (1.3 liters)
steering gear, power	1.15 US qts/1.0 Imp. qts. (1.1 liters)

pg. 82 Specifications

ENGINE

4-cylinder in-line fluid-cooled gasoline engine. Cylinder block in special cast iron, bores directly in the block.

Cylinder head in light-alloy, separate inlet and exhaust passages.

Single, overhead camshaft.

Engine oiling is provided by a gear pump driven from the crankshaft. Full-flow type oil filter. Exhaust emission control accomplished by fuel injection. Air Injection Reactor and Exhaust Gas Recirculation (some models also equipped with catalytic converter). Closed crankcase ventilation system and evaporative emission control system.

Type designation

Volvo B21 F

Output (SAE J 245) at/rpm

102 hp¹/5200

Max. torque (SAE J 245) at/rpm	114 lb.ft. (16.3 Nm)/2500
Number of cylinders	4
Bore	3.62" (92 mm)
Stroke	3.15" (80 mm)
Displacement	2.13 liters
Valves	overhead
Valve clearance, inlet and exhaust, warm engine	0.012-0.020" (0.30-0.50 mm) when checking 0.010-0.018" (0.40-0.45 mm) when adjusting

1) With catalytic converter: 99 hp

Cooling system

Type:	Positive pressure, closed system
Thermostat begins to open at	189°F (87°C)
fully open at	207°F (97°C)
Fan belts, designation	HC-38 X 925

Fuel system

The engine is equipped with fuel injection system.

pg. 83 Specifications

Ignition System

Firing order	1-3-4-2
Ignition setting, vacuum regulator disconnected	15°+/-2° B.T.D.C. (at 9000+/-50 rpm)
Spark plugs	Volvo Part No. 273545 (Bosch W 175 T 30*)
Spark plug gap	0.028-0.032" (0.7-0.8 mm)
Tightening torque	14.5-21.7 ft. lbs. (20-30 Nm)
Distributor, direction of rotation	Clockwise

ELECTRICAL SYSTEM

12 V, negative ground.

Voltage-controlled alternator. Single-wire system with chassis and engine used as conductors.

Voltage	12 V
---------	------

Battery, type	Tudor 6 EX 45 o.p. *
-Capacity	60 Ah
-Electrolyte, specific gravity	1.28
-Recharge at	1.21
Alternator , rated output	770 W
- max. current	55 A

* or corresponding

Lights, 12 V	US bulb No.	Power	Socket	No. of bulbs
Headlights	7" Type 2	Sealed Beam		2
Position Lights, front	67	5 W/4 cp	Ba 15s	2
Turn Signals, front	1073	21 W/32 cp	Ba 15s	2
Turn Signals, rear	1073	21 W/32 cp	Ba 15s	2
Tail lights	67	5 W/4 cp	Ba 15s	2
Stop Lights	1073	21 W/32 cp	Ba 15s	2
Back-up Lights	1073	21 W/32 cp	Ba 15s	2
Side Marker Lights	57	3 W/2 cp	S 8.5	2
The following bulbs may be obtained from your nearest Volvo dealer.				
Rear Ash Tray Light		1.2 W	W1.8d	1
License Plate Light		5 W	S 8.5	2
Interior Light		10 W	S 8.5	1(245:2)
Glove Locker Light		2 W	Ba9s	1
Instrument Panel Light		2 W	Ba7s	3
Control Panel Light		1.2 W	W1.8d	3
Shift positions, Auto Transmission		1.2 W	W1.8d	1
Engine Compartment Light		15 W	S 8.5	1
Warning Lamps				
Charging		1.2 W	W1.8d	1

Turn Signals	1.2 W	W1.8 d	2
Brake Failure	1.2 W	W1.8 d	1
Parking Brake	1.2 W	W1.8 d	1
Headlights	1.2 W	W1.8 d	1
Oil Pressure	1.2 W	W1.8 d	1
Overdrive	1.2 W	W1.8 d	1
Warning Flashers	1.2 W	W1.8 d	1
El. Heated Window	1.2 W	W1.8 d	1
EGR Reminder	1.2 W	W1.8 d	1
Seat Belts	2 W	Ba9s	1
Bulb Failure	1.2 W	W1.8 d	1

pg. 84 Specifications

Front End

Suspension is of the McPherson type with the shock absorber mounted in a strut in the coil spring.

Rack and pinion steering gear.

Some models come equipped with power steering.

Safety steering column.

Front wheel alignment

The alignment specifications apply to an unloaded car but include fuel, coolant and spare wheel.

Toe-in : 0.17+/- 0.06" (4.5 +/- 1.5 mm)

0.12+/- 0.06" (3.0 +/- 1.5 mm)

(models equipped with power steering)

Camber : +1° to +1 1/2°

POWER TRANSMISSION

Cable-operated clutch of the single, dry-plate type.

Floor-shift operated manual transmission has four synchromesh forward gears and one reverse.

Overdrive available on some models.

Optional automatic transmission.

Hypoid type final drive. Limited slip differential is optional.

Clutch

Clutch release arm play approx 1/8" (3mm)

Transmission

Type designation: **M45 M46 BW55**

Reduction ratios:

1st gear	3.71:1	3.71:1	2.45:1
2nd gear	2.16:1	2.16:1	1.45:1
3rd gear	1.37:1	1.37:1	1.00:1
4th gear	1.00:1	1.00:1	-
Overdrive	-	0.80:1	-
Reverse	3.68:1	3.68:1	2.21:1

Rear axle

USA (not California), Canada 3.91:1 4.10:1 3.91:1

California 4.10:1 4.10:1 4.10:1

Speeds in mph (kmph) at 1000 engine rpm

Transmission:	M45	M45	M46
Rear axle ratio	3.91:1	4.10:1	4.10:1
1st gear	5.0(8.1)	4.8(7.7)	4.8(7.7)
2nd gear	8.6(13.9)	8.3(13.4)	8.3(13.4)
3rd gear	13.6(21.9)	13.0(20.8)	13.0(20.8)
4th gear	18.7(30.0)	17.9(28.7)	17.9(28.7)
Overdrive	---	---	22.3(35.9)
Reverse	5.1(8.2)	4.9(7.8)	4.9(7.8)

Recommended max. and min. speeds, mph (kmph)

Rear axle ratio	1st gear	2nd gear	3rd gear	4th gear
3.91:1	-25(-40)	10-44(20-70)	20-70(30-110)	25- (40-)
4.10:1	-25(-40)	10-44(20-70)	20-68(30-105)	25- (40-*)

*40 mph(60 km/h) with overdrive engaged

Tool kit

Wheel nut and spark plug wrench.

2 screwdrivers (1 Phillips, 1 standard)

Tommy bar.

2 open end wrenches

Tires

Car model	Tire	Recommended tire infl. pressure cold tires, psi (kp/cm ²)				Max. permitted inflation pressure psi (kp/cm ²)	Capacity weight, lbs
		1-3 persons		Full load			
		Front	Rear	Front	Rear		
242/244	CR 78-14 175 R 14	26 (1.8)	28 (1.9)	26 (1.8)	32 (2.2)	32 (2.2)	920
245	DR 78-14 185 R 14	26 (1.8)	28 (1.9)	26 (1.8)*	32 (2.2)*	32 (2.2)	1095

* For driving with full load, speed must be limited to 75 mph.

pg. 86 Customer information

Consumer information**Acceleration and passing ability**

Vehicle stopping distance

Tire reserve load

The information concerning the 1976 Volvo 242, 244 and 245 shown in the following pages is presented in accordance with Federal requirements for comparison with other makes and models. The exacting test procedures established by the National Highway Traffic Safety Administration were followed to obtain the figures.

Notice: This information represents results recorded by skilled drivers under controlled road and vehicle conditions and the information may not be applicable to other conditions.

Acceleration and Passing ability

This chart indicates passing times and distances that can be met or exceeded by 1976 Volvo 242, 244 and 245 in the situations diagramed below.

Low speed

Initial speed: **20 mph**

55' Truck

The low-speed pass assumes an initial speed of 20 mph and a limiting speed of 35 mph.

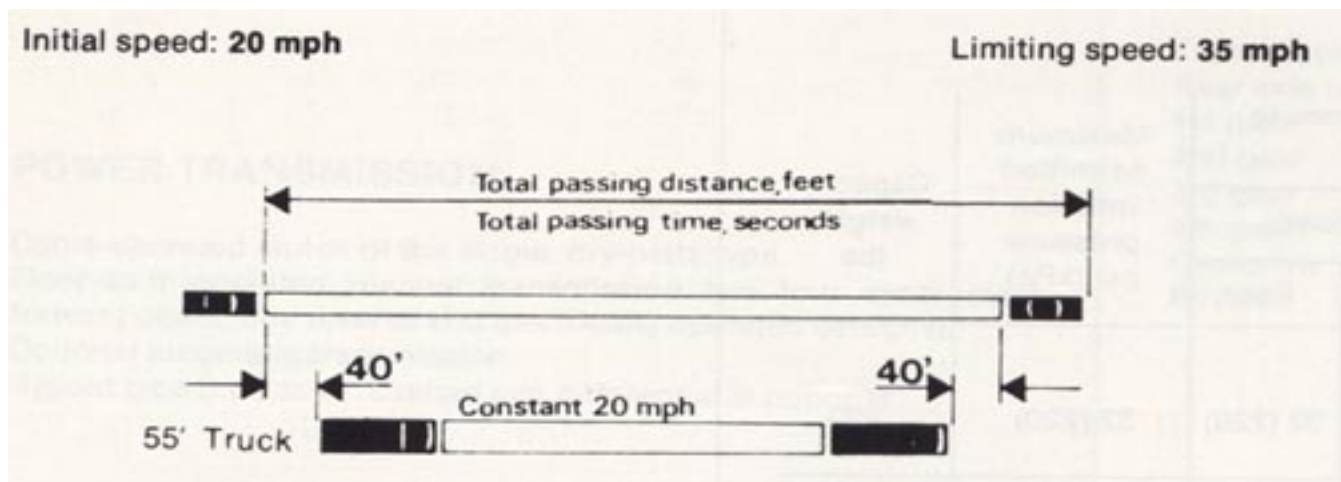

Model (vehicle without catalytic converter)	Low speed	
	Feet	Seconds
242/244 Std Transmission	414	8.8
242/244 Overdrive	414	8.8
242/244 Automatic	420	9.0
245 Std Transmission	414	8.8
245 Overdrive	414	8.8
245 Automatic	424	9.1

Model (vehicle with catalytic converter)	Low speed	
	Feet	Seconds
242/244 Std Transmission	414	8.8
242/244 Overdrive	414	8.8
242/244 Automatic	424	9.1
245 Std Transmission	414	8.8
245 Overdrive	414	8.8
245 Automatic	427	9.2

pg. 87 Customer information

High speed

The high speed pass assumes an initial speed of 50 mph and a limiting speed of 80 mph.

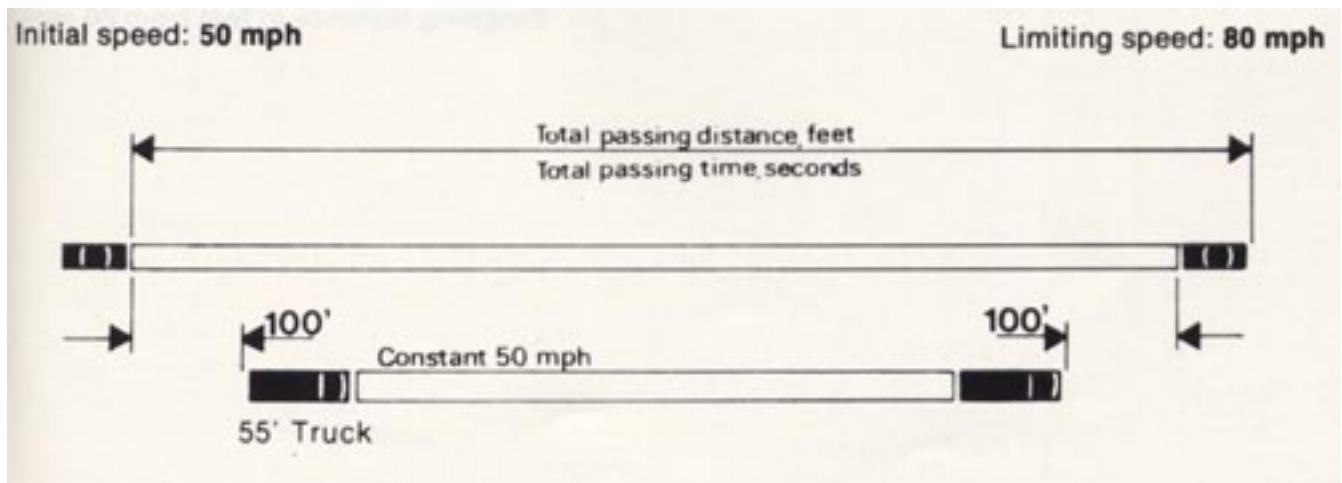

Model (vehicle without catalytic converter)	High speed	
	Feet	Seconds
242/244 Std Transmission	1349	14.5
242/244 Overdrive	1349	14.5
242/244 Automatic	1437	15.6
245 Std Transmission	1368	15.0
245 Overdrive	1368	15.0
245 Automatic	1470	16.1

Model (vehicle with catalytic converter)	High speed	
	Feet	Seconds
242/244 Std Transmission	1378	14.9
242/244 Overdrive	1359	14.6
242/244 Automatic	1444	15.8
245 Std Transmission	1454	15.9
245 Overdrive	1398	15.1
245 Automatic	1483	16.3

pg. 88 Customer information

Vehicle Stopping Distance

This chart indicates braking performance that can be met or exceeded by 1976 Volvo 242 and 244 without locking the wheels, under different conditions of loading and with partial failures of the braking system. This information represents results recorded by skilled drivers under controlled road and vehicle conditions and the information may not be applicable to other conditions.

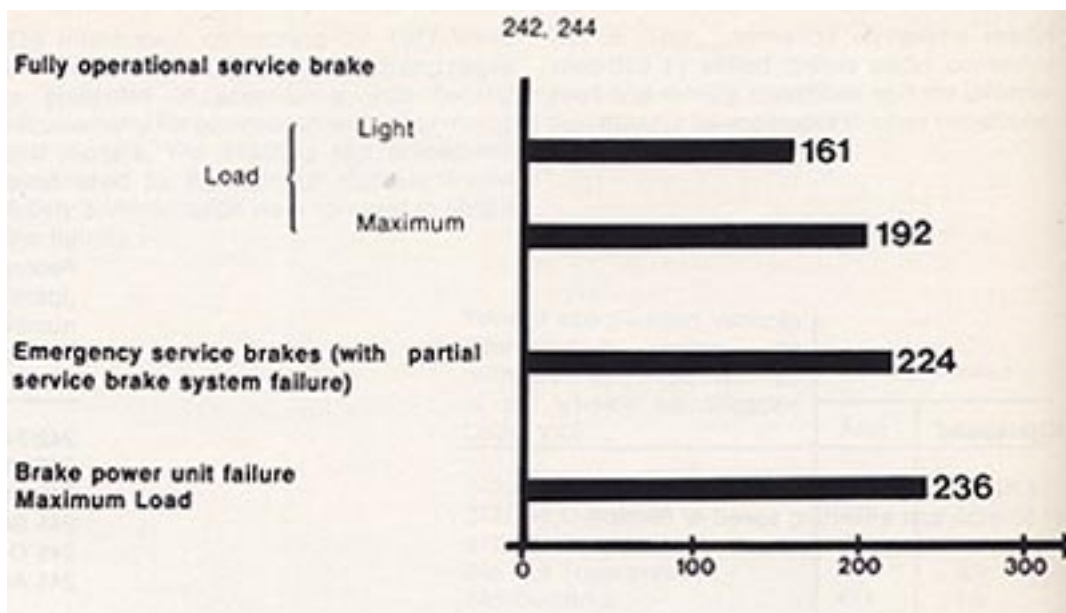

Stopping distance in feet from 60 mph

pg. 89 Customer information

Vehicle Stopping Distance

This chart indicates braking performance that can be met or exceeded by 1976 Volvo 245 without locking the wheels, under different conditions of loading and with partial failures of the braking system. This information represents results recorded by skilled drivers under controlled road and vehicle conditions, and may not be applicable to other conditions.

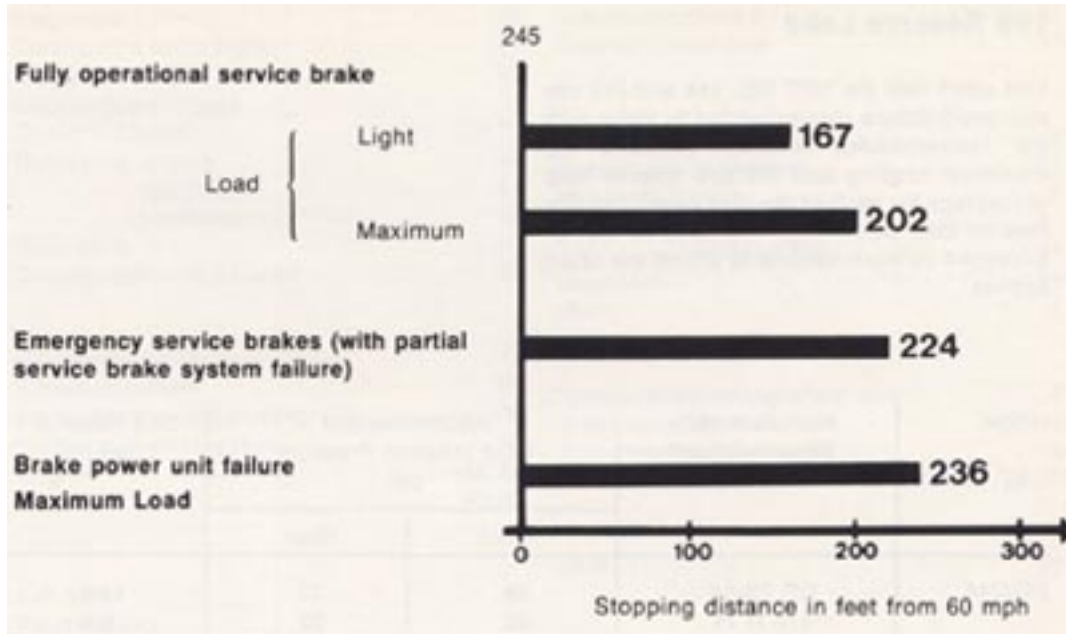

Stopping distance in feet from 60 mph

pg. 90 Customer information

Tire Reserve Load

This chart lists the 1976 242, 244 and 245 tire size designations recommended by Volvo with the recommended inflation pressure for maximum loading and the tire reserve load percentage for each of the tires listed. The tire reserve load percentage indicated is met or exceeded by each vehicle to which the chart applies.

Model	Manufacturer's Recommended Tire Size	Recommended Cold Inflation Pressure psi		Tire Reserve Load (%)
		Front	Rear	
242/244	CR78-14	26	32	11.4
	175 R 14	26	32	8.5
245	DR78-14	26	32	1.5
	185 R 14	26	32	4.4

The difference, expressed as a percentage of tire load rating, between (a) the load rating of a tire at the vehicle manufacturer's recommended inflation pressure at the maximum loaded vehicle weight and (b) the load imposed upon the tire by the vehicle at that condition.

WARNING. Failure to maintain the recommended tire inflation pressure or to increase tire pressure as recommended when operating at maximum loaded vehicle, or loading the vehicle beyond the capacities specified on the tire placard affixed to the vehicle, may result in unsafe operating conditions due to premature tire failure, unfavorable handling characteristics and excessive tire wear. The tire reserve load percentage is a measure of tire capacity not of vehicle capacity. Loading beyond the specified vehicle capacity may result in failure of other vehicle components.



[Contents](#) | [Top of Page](#)

1 9 7 6 VOLVO 242, 244, 245

pg. 91-92 Index

A

Air Conditioning	16
Alternator, important note	60
Anti-freeze	59
Anti-rust treatment	69
Ash trays	12
Automatic transmission, driving	34
Automatic transmission, oil	56

B

Battery	42
Body and chassis	58
Brake fluid	42 , 57
Brakes	39
Breaking in	31
Bulb failure warning light	7
Bulbs	60 , 83

C

Capacities	81
Chassis number	80
Checking coolant	42 , 59
Checking oil	48
Child safety locks	23
Cigarette lighter	12
Clock	12

Cold start	32
Cold weather driving	73
Consumer Information	86
Control lights	6
Coolant	59
Coolant, drain	49
D	
Defroster	14
Dimensions and weights	81
Dipstick	48
Door lock anti-freeze	73
Doors and locks	22 , 73
Drain plug, engine	48
Drain plug, rear axle	57
Drain plug, transmission	56
Drive belts	49
Driving with trunk lid open	39
E	
Electrically heated rear window	13
Electrical system	83
Emergency towing(pulling)	36
Emission control system	50
Engine oil	42 , 48
F	
Fan belt	49
Fault tracing	75
Federal Clean Air Act	41
Fresh-air controls	15
Front seats	18
Front wheel alignment	84
Frozen locks	22

Fuel	26 , 42
Fuel gauge	6
Fuel tank cap	26
Fuses	64
G	
Gas filler cap	26
Gasoline	26 , 42
Gas station checks	42
Gear shift positions	33
H	
Hand brake	8
Hazard warning flasher	13
Headlight flasher	9
Headlights	61
Headlights replacement	61
Hood lock	24
Horn	4
I	
Ignition and steering wheel lock	8
Instrument lights	9
Instruments and controls	4
Interior light	26 , 63
J	
Jack	66 , 85
K	
Keys	3
Kick-down	35
L	
License plate lights	63
Lighting	9
Limited slip differential	57

Locks	22
Long distance trips	72
Lubrication	58
Lumbar support	18
M	
Maintenance Service	41
O	
Odometer	6
Oil change, engine	48
Oil change, rear axle	57
Oil change, transmission	56
Oil filter	48
Oil pressure	7
Overdrive	33
P	
Paint touch-up	70
Parking brake	8
Parking lights	9
Polishing	68
Power steering	57
R	
Rear axle oil	57
Rear seat, 245	27
Rear view mirrors	25
Rear Window heating	13
S	
Seat belts	20
Seats	18
Service diagnosis	75
Servicing	42
Shift positions	33
Snow chains	65

Snow tires, studded tires	65
Spare wheel	29
Spark plugs	83
Specifications	80
Speedometer	6
Starting engine	32
Starting key	3
Steering wheel lock	8
Storage space, 245	29
Sun roof	26
T	
Tachometer	6
Tail gate	28
Tail gate window washer/wiper	13
Temperature gauge	6
Tire pressure	65
Tire reserve load	90
Tires	65
Tire wear indicator	65
Tools	85
Touch-up	70
Trailer hauling	38
Transmission oils	56
Trunk, 242, 244	23
Turn signals	10
Type designations	80
U	
Upholstery, cleaning	69
V	
Vehicle Identification Number	80
Ventilation outlets	14
Vent windows	25

W

Warning lights	7
Warranty	41
Warranty inspection	31
Washer fluid	43 , 73
Washer nozzles	11
Washing	68
Waxing	68
Weights	81
Wheel change	66
Wheels and tires	65
Wintertime driving	73
Wipers	11

Back Cover

Tire Pressures

Car model	Tire	Recommended tire infl. pressure cold tires, psi (kp/cm ²)				Max. permitted inflation pressure psi (kp/cm ²)	Capacity weight, lbs
		1-3 persons		Full load			
		Front	Rear	Front	Rear		
242/244	CR 78-14 175 R 14	26 (1.8)	28 (1.9)	26 (1.8)	32 (2.2)	32 (2.2)	920
245	DR 78-14 185 R 14	26 (1.8)	28 (1.9)	26 (1.8)*	32 (2.2)*	32 (2.2)	1095

* For driving with full load, speed must be limited to 75 mph.



[Contents](#) | [Top of Page](#)

