

# 1 9 8 9 VOLVO 240

## Important

**You should be familiar with the information in the first two chapters before you operate the car. Information contained in the balance of the manual is extremely useful and should be studied shortly after operating the vehicle for the first time. The manual is structured so that it can be used for reference. It should thus be kept in the car for ready access.**

## Contents

### [Introduction to the manual](#)

### [Before you drive](#)

This section provides a detailed description of the vehicle's instruments and controls.

### [Operating the car](#)

This section contains items such as starting the engine, operating gear selector, towing trailers.

### [Service and maintenance](#)

An investment which will pay dividends in the form of improved reliability, durability, and resale value.

### [Specifications](#)

All specifications are subject to change without notice. Consult your Volvo dealer for information.

### [Index](#)

Should you require more detailed information please contact your Volvo dealer.

All information, illustrations and specifications contained in this manual are based on the latest product information available at the time of publication. Volvo reserves the right to make model changes at any time, or to change specifications or design, without notice and without incurring obligation.

pg. 2 This manual deals with the operation and care of your Volvo

Welcome to the world-wide family of Volvo owners. We trust that you will enjoy many years of safe driving in your Volvo, an automobile designed with your safety and comfort in mind. To ensure your satisfaction with this vehicle, we encourage you to familiarize yourself with the equipment descriptions, operating instructions, and maintenance requirements/recommendations in this manual. We also urge you and your passengers to wear seat belts at all times in this (or any other) automobile. And, of course, please do not operate a vehicle if you may be affected by alcohol, medication, or any impairment that could hinder your ability to drive.

Your Volvo is designed to meet all applicable safety and emission standards, as evidenced by the certification labels attached to the door opening sheet metal and on the left wheel housing in the engine compartment. For further information regarding these regulations, please contact your dealer.

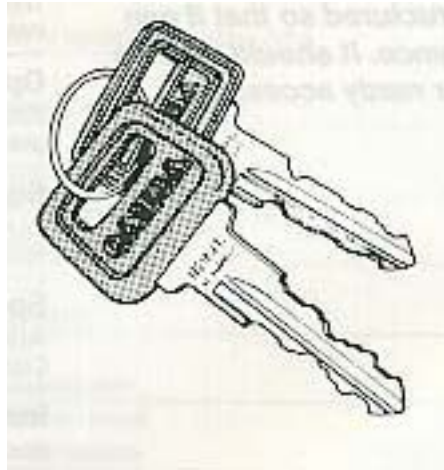

### pg. 3 Seatbelts: "Something We Believe In"

Despite our strongest recommendation, and your best intentions, not wearing a seatbelt is like believing "it'll never happen to me!", Volvo urges you and all adult occupants of your car to wear seatbelts and ensure that children are properly restrained, using an infant, car or booster seat determined by age, weight and height.

**Fact:** In every state, some type of child-restraint legislation has been passed. Additionally, some states are seriously considering, or have already made it mandatory for occupants of a car to use seatbelts.

So, urging you to 'buckle up' is not just our recommendation - its becoming the law! The few seconds it takes to buckle up may one day allow you to say, "Its a good thing I was wearing my seatbelt."



## pg. 4 General Information

Do not export your Volvo to another country before investigating that country's applicable safety and exhaust emission requirements. In some cases it may be difficult or impossible to comply with these requirements. Modifications to the emission control system(s) may render your Volvo non-certifiable for legal operation in the U.S., Canada and other countries

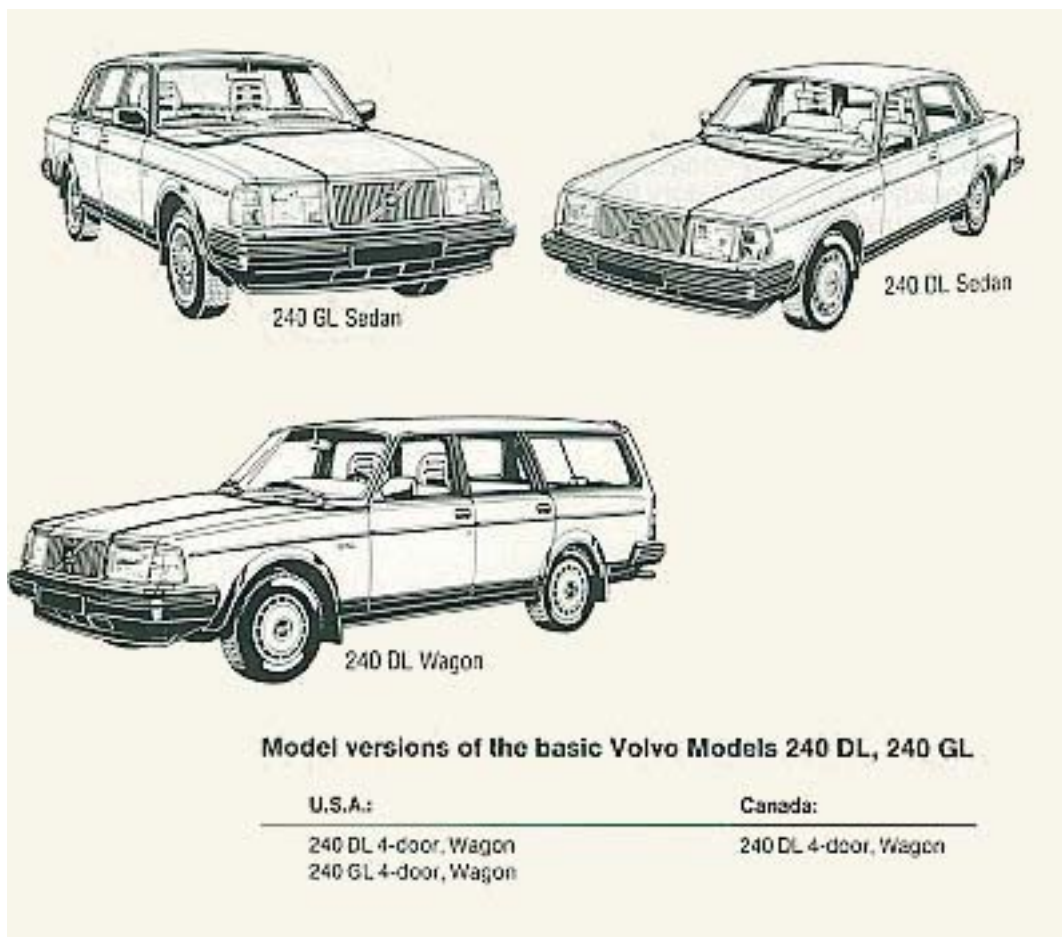

## pg. 5 Keys

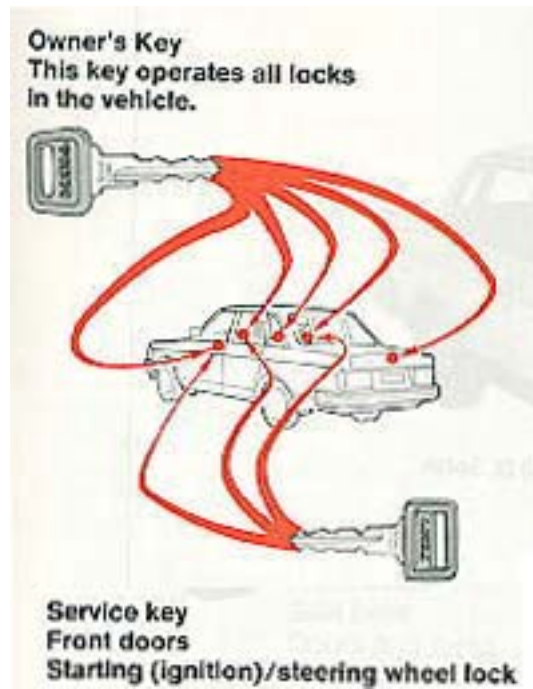

The key number codes are stamped on a separate tag supplied with the keys. This tag should be separated from the key ring and kept in a safe place.

The double-sided tape on the back of the tag can be used to secure it safely.

In the event the original keys are lost, duplicates may be ordered from your Volvo dealer.



[Top of Page](#)

# 1989 VOLVO 240

## Before you drive

pg. 6 240 DL Sedan



pg. 7 Before you drive

Instruments and controls 8

Instruments 10

Warning lights 11

Clock, ambient temperature gauge 12

Oil pressure gauge, voltmeter 13

Ignition switch, turn signals 14

Lighting 15

Windshield wipers, washer nozzles 16

<u>Washer fluid reservoir</u>	<u>17</u>
<u>Rear window demister, heated seat, hazard warning flasher</u>	<u>18</u>
<u>Parking brake</u>	<u>19</u>
<u>Cigarette lighter, ash trays</u>	<u>20</u>
<u>Electrically operated windows</u>	<u>21</u>
<u>Heating and ventilation</u>	<u>22</u>
<u>Air conditioning</u>	<u>24</u>
<u>Radios, AM-FM-FM stereo/tape players</u>	<u>25</u>
<u>Front seats</u>	<u>26</u>
<u>Seat belts</u>	<u>28</u>
<u>Doors and locks</u>	<u>30</u>
<u>Trunk lid</u>	<u>31</u>
<u>Hood release, long load storage</u>	<u>32</u>
<u>Rear/side view mirrors</u>	<u>33</u>
<u>Interior light, sun roof, fuel tank cap</u>	<u>34</u>
<u>Rear seat (wagon)</u>	<u>35</u>
<u>Tailgate (wagon)</u>	<u>36</u>
<u>Cargo compartment (wagon)</u>	<u>37</u>

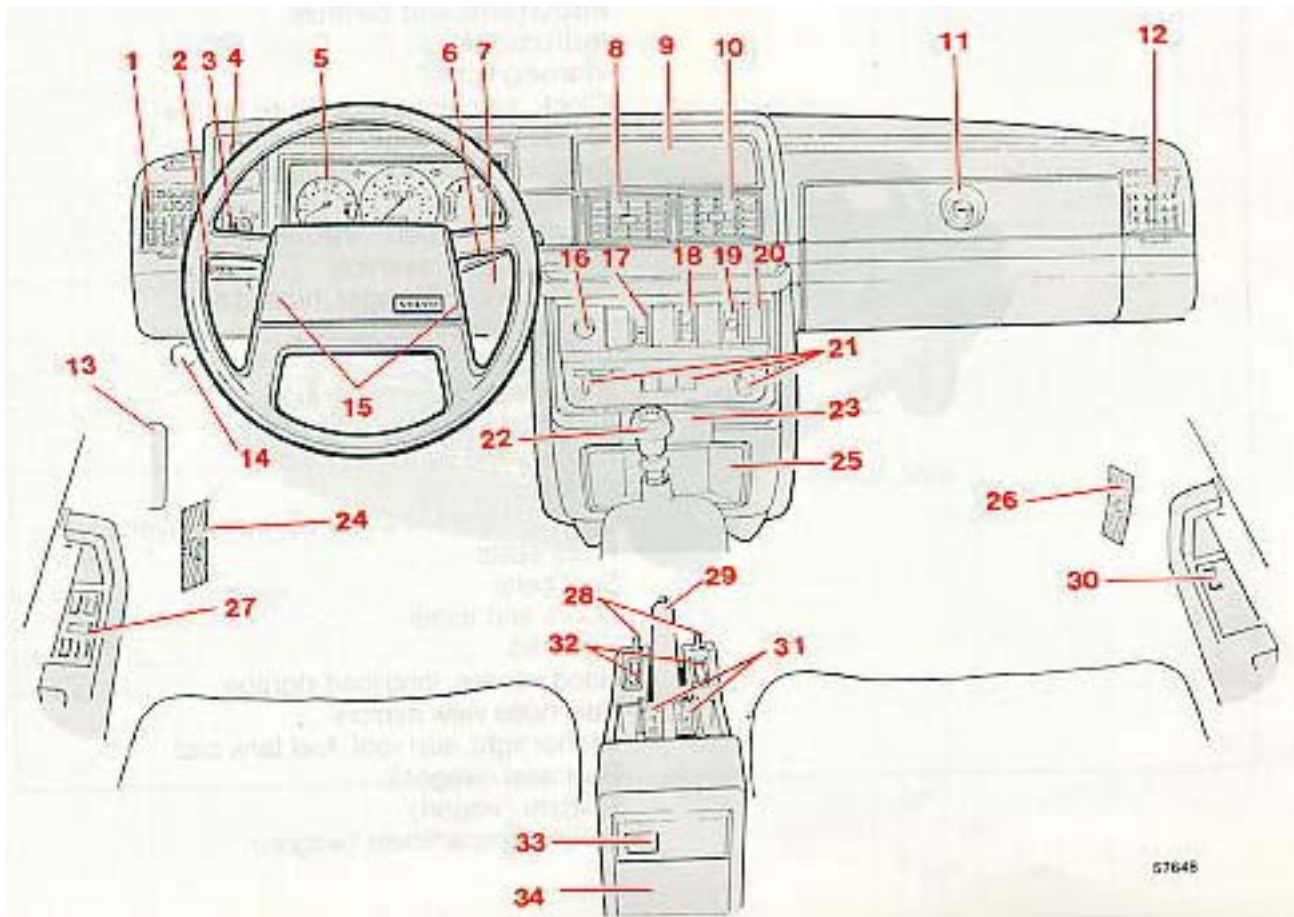

pg. 9 Instruments and controls

See page

- 1 Air louver [23](#)
- 2 Turn signals [14](#)
- 3 Headlights, parking lights [15](#)
- 4 Instruments, lights [15](#)
- 5 Instruments [10](#)
- 6 Wiper/washer, tailgate window wiper/washer (wagon) [16, 17](#)
- 7 Starting (ignition) switch/steering wheel lock [14](#)
- 8 Air louver [23](#)
- 9 Storage compartment (extra instrument or radio location) [25](#)
- 10 Air louver [23](#)
- 11 Glove box -
- 12 Air louver [23](#)
- 13 Fuse box [79](#)
- 14 Hood release handle [32](#)
- 15 Horn -

	<b>16 Cigarette lighter</b>	<b><a href="#">20</a></b>
	<b>17 Rear window demister</b>	<b><a href="#">18</a></b>
	<b>18 Hazard warning flashers</b>	<b><a href="#">18</a></b>
<b>19 Air conditioning</b>	<b>(some models)</b>	<b><a href="#">24</a></b>
	<b>20 Seat belt reminder light</b>	<b><a href="#">28</a></b>
	<b>21 Heating and ventilation</b>	<b><a href="#">22</a></b>
	<b>22 Gear lever or gear selector</b>	<b><a href="#">43, 44</a></b>
	<b>23 Ash tray</b>	<b><a href="#">20</a></b>
<b>24 Fresh air louver</b>	<b>(except models with air conditioning)</b>	<b><a href="#">23</a></b>
	<b>25 Storage compartment -</b>	
	<b>26 Fresh air louver</b>	<b><a href="#">23</a></b>
	<b>27 Electrically-operated windows (240 GL)</b>	<b><a href="#">21</a></b>
<b>28 Control for electrically operated side mirrors</b>	<b>(certain models only) -</b>	
	<b>29 Parking brake</b>	<b><a href="#">19</a></b>
<b>30 Electrically-operated window, right front door (240 GL)</b>		<b><a href="#">21</a></b>
	<b>31 Seat belt release buttons</b>	<b><a href="#">28</a></b>
	<b>32 Seat heaters</b>	<b><a href="#">19</a></b>
	<b>33 Seat belt reminder light</b>	<b><a href="#">24</a></b>
	<b>34 Ash tray</b>	<b><a href="#">20</a></b>

The pages in this section provide a detailed description of the vehicle's instruments and controls.

Note that some vehicles may be equipped differently, depending on model, special legal requirements, etc.

## pg. 10 Instruments

### **A Clock or Tachometer (depending on model)**

Tachometer reads thousands of engine rpm. Engine should not be operated in red range.

### **B Direction indicator (green)**

### **C Speedometer**

In kilometers and miles per hour (U.S. models) In kilometers per hour (Canadian models)

### **D Odometer**

Total reading in miles (U.S. models) Total reading in kilometers (Canadian models)



## E Temperature gauge

The gauge pointer should remain **Inside the black range during normal operation.**

If the pointer enters the red range repeatedly, check coolant level and fan belt tension (See sections titled "Cooling system and coolant")

### **WARNING!**

allow engine to cool before adding fluid.

**Do not continue to drive the car with the pointer in the red zone.**

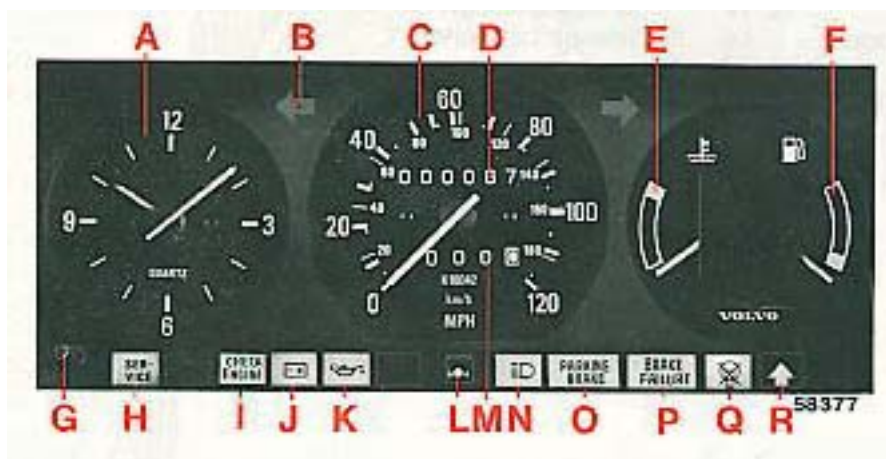

## F Fuel gauge

The fuel tank capacity is approx. 60 liters 15.8 US gals. See "Fuel requirements".

## G Clock reset knob (DL)

## H Service reminder light

## I Check engine (red)

## J Alternator warning light (red)

## K Oil pressure warning light (red)

Do not drive the car with this light on.

## L Trip odometer reset knob

Push in to reset

**M Trip odometer**

**N High beam indicator (blue)**

**O Parking brake reminder light (red)**

**P Brake failure warning light (red)**

**Q Bulb failure warning light (yellow)**

**R Overdrive OFF indicator light (yellow)**  
(automatic transmission models)

**Shift indicator light (yellow)**  
(manual transmission models)

pg. 11 Warning lights

## The warning lights described on this page should never be on when driving

When the ignition is turned on, and before the engine starts, all of the warning lights should be on to test the function of the bulbs. Should a light not go off after the engine has started, the system indicated should be inspected. (However, the parking brake reminder light will not go off until the parking brake is fully released.)



**Alternator warning light (red)**

If the light comes on while the engine is running, check the tension of the alternator drive belt as soon as possible. (See section titled "Cooling system".)

NOTE: This warning light is illuminated if the alternator is not charging. However, **alternator, parking brake, brake failure, and bulb failure will be illuminated at the same time** due to the design of the system.



**Oil pressure warning light (red)**

If the light comes on during driving, the oil pressure is too low. Stop the engine immediately and check the engine oil level. See section titled "Engine Oil". Do not continue to drive the car with this light on. After hard driving, the light will come on occasionally when the engine is idling. This is normal, provided it goes off when the engine speed is increased.



### **Parking brake reminder light (red)**

This light will be on when the parking brake (hand brake) is applied. The parking brake lever is situated between the front seats.



### **Brake failure warning light (red)**

If the light comes on while driving and the brake pedal can be depressed further than normal, it is an indication that one of the brake circuits is not functioning. **Stop immediately, open engine hood and check brake fluid level** (see section "Brake fluid, power steering").

**Reservoir empty:** do NOT drive. Tow car to shop for check/repair of brake system. **Reservoir not empty:** proceed immediately and with **caution** to a Volvo dealer for an inspection of the brake system.



### **Bulb failure warning light (yellow)**

The light will come on if any of the following bulbs are defective:

one of the lower beams

one of the tail lights

one of the brake lights (when the brake pedal is depressed).

See section on "Replacing Bulbs".

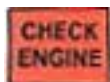

### **Check Engine warning light**

If the light comes on (or stays on after the vehicle has started), the Engine Check diagnostic system has detected a fault. Drive to an authorized Volvo dealer for inspection.

pg. 12 Service reminder light, Clock, ambient temperature gauge



### **Service reminder light**

This light will come on at 5,000 mile (8,000 km) intervals. It is a reminder to the driver that the 5,000

mile (8,000 km) service interval has been exceeded. The light will stay on 2 minutes after start until reset by the servicing dealer.



### **Quartz crystal clock**

To reset the hands, push in the reset knob and turn.



### **Ambient temp. gauge (accessory)**

An electronic thermometer that indicates ambient temperature just above the road surface. Warns you of icy road conditions

pg. 13 Oil pressure gauge, Voltmeter



### Oil pressure gauge (accessory)

The oil pressure gauge indicates the pressure of the oil in the lubricating system of the engine. The pressure is dependent on the speed of the engine, the oil temperature and the viscosity of the oil.

**The gauge pointer must not go down to the red field while driving.**

**Do not continue to drive the car with the pointer in the red zone.**

**Note:** While idling with a hot engine the pointer may go into the red field. This is not a cause for concern providing the pointer rises to the normal driving range again when you increase the engine speed.

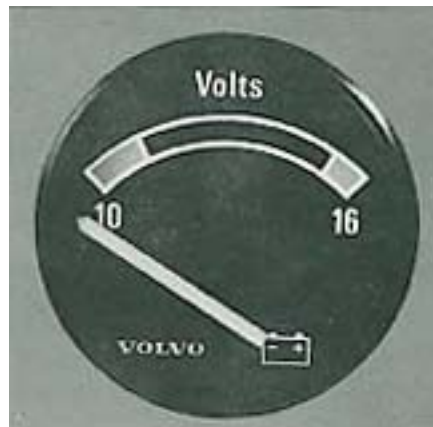

### Voltmeter (accessory)

The voltmeter indicates the voltage in the electrical system and thereby also the state of the battery.

While the car is being driven the pointer should be within the black field.

Should the pointer point to the upper or lower red field when driving, this may indicate some fault in the electrical system,

**Note:** While idling with a hot engine (especially with air conditioning ON), the pointer may indicate low voltage. This is not a cause for concern provided that the indicated voltage increases when you increase

engine speed.

## pg. 14 Starting (ignition) switch, Turn signals

### Starting (ignition) switch/steering wheel lock

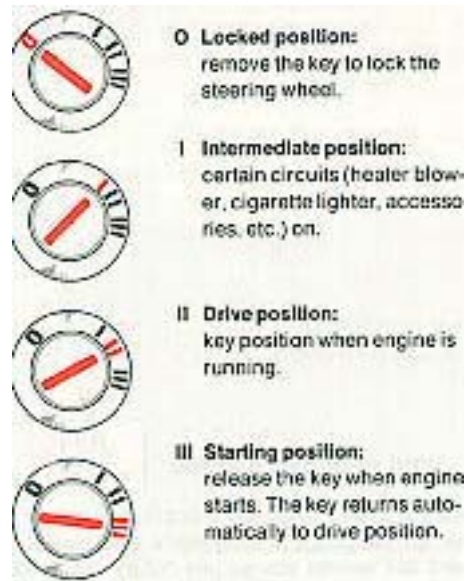

The steering wheel lock may be under tension when the car is parked. Turn the steering wheel slightly to free the ignition key.

A chime will sound if the starting key is in the ignition lock and the front door on the driver's side is open. The chime will also sound if the headlights or parking lights are on when the door is open.

The chime goes off when the front door is closed.



### Turn signals

**1 Signal lever engaged for normal turns.**

**Note:** A defective turn signal bulb will cause turn signal indicator and remaining signal lights to flash more rapidly than normal.

**2 Lane change position.** In maneuvers such as lane changing, the driver can flash the turn signals by moving the turn signal lever to the first stop and holding it there. The lever will return to the neutral position when released.



**3 High and low beam switching (headlights on).**

Move the lever towards the steering wheel and release it.

**3 Headlight flasher (headlights off).**

Move the lever towards the steering wheel. The headlight high beam will be on until the lever is released.

pg. 15 Lighting



## Headlights and position lights

▣ All lights off

 Parking lights on

 Headlights and parking lights on

Switch from upper to lower beams, and vice versa, by moving the turn signal switch lever on the left side of the steering column towards the steering wheel. The parking lights can be used without switching on the starting (ignition) key.



A chime will sound if the starting (ignition) key is in the switch lock when the door is open. The chime goes off when the driver's door is closed.

If the headlight is in position , all lights will go out when starting (ignition) switch is switched off.



### Instrument panel lamps rheostat

Clockwise - brighter

Counterclockwise - dimmer.



pg. 16 Windshield wipers, Tailgate window wiper, Washer nozzles

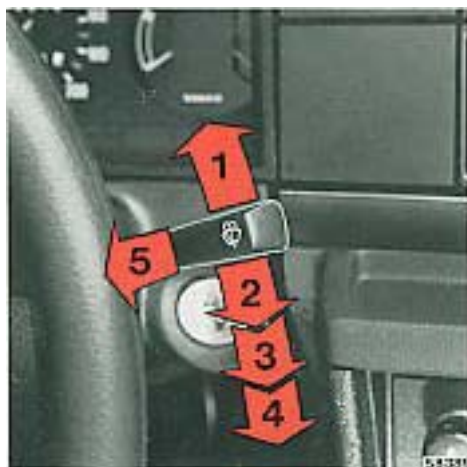

## Wiper/washer

### 1 Intermittent wiper.

With switch in this position, the wipers will make a stroke approx. every seventh second.

### 2 "Single stroke" position.

Switch returns automatically when released.

### 3 Wipers, low speed.

### 4 Wipers, high speed.

### 5 Windshield wiper/washer.

The wiper will make 2-3 complete stroking cycles after the lever is released.

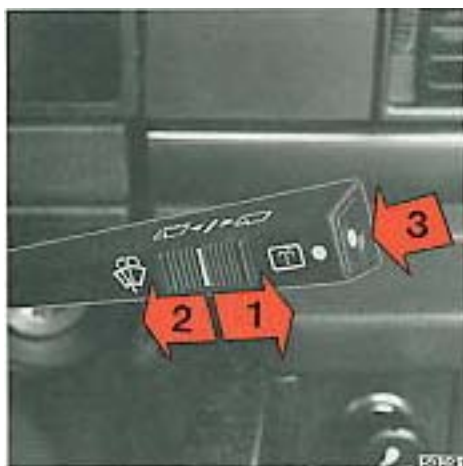

## Tailgate window wiper/washer, wagon

Operated by the switch at the end of the windshield wiper/washer operating lever.

### 1 Tailgate wiper

### 2 Interval position

With the switch in this position, there is one stroking cycle approx. every fifteen seconds.

### 3 Tailgate washer

Depress the button to start the-wiper/washer.

The wiper will complete 2-3 stroking cycles after the button is released.

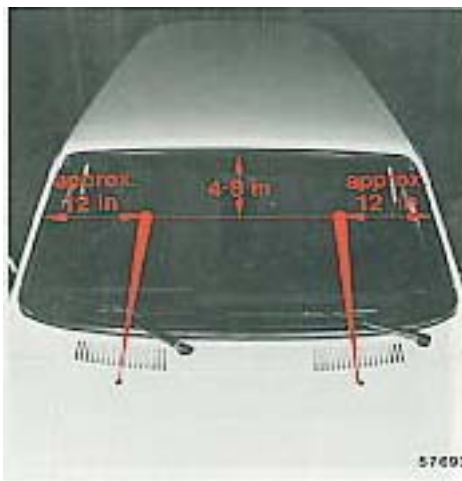

### Adjusting washer nozzles

The fluid spray may be adjusted by carefully inserting a needle into the metal nozzle and rotating nozzle to desired position.

4-8" = 10-20 cm. 12" = 30 cm.



### Washer fluid reservoir

The washer fluid reservoir for the windshield and tailgate washer (wagon) is located in the engine compartment and holds approx. 0.8 US gals = 3.2 liters.

During wintertime, the reservoir should be filled with anti-freeze washer Fluid specified in section titled "Cold weather".



### Rear fog lights

The rear fog lights are considerably brighter than the normal tail lights and should be used only when atmospheric conditions, such as fog, rain, snow, smoke or dust reduce the daytime or night time visibility of other vehicles to less than 500 ft. (152 meters). (The headlights must be switched on.)

Note that local regulations governing the use of these lights may vary.



### Rear window demister

To operate depress the switch. The indicator lamp in the switch will come on. The system will be switched off automatically after 10-15 minutes or when the starting (ignition) key is switched off. Do not place items against the inner surface of the rear window that may damage the printed circuit. Do not scrape the inner surface of the rear window glass with a hard object or use an abrasive window cleaner, otherwise damage to the printed circuit will occur.

### Hazard warning flasher

The four-way flasher should be used to indicate that the vehicle has become a traffic hazard.

**Note:** Regulations regarding the use of the hazard warning flasher may vary from state to state.

pg. 19 Parking brake



### Parking brake (hand brake)

The lever is situated between the front seats. The brake is applied to the rear wheels. The PARKING

**BRAKE** reminder light on the instrument panel comes on whenever the parking brake lever is not fully released and the ignition is on.

Always use the parking brake (hand brake) when parked.

In order to obtain the best possible performance of the parking brake, the brake linings should be broken in. (See section titled "Break-in period".)



### Seat heaters

The front seats are equipped with electrically- heated backrests and seat cushions. The switches engage the heating which then is thermostatically controlled. It switches on automatically when the temperature drops below 60°F (15°C) and switches off at approx. 95°F(35°C).

pg. 20 Cigarette lighter, Ash trays

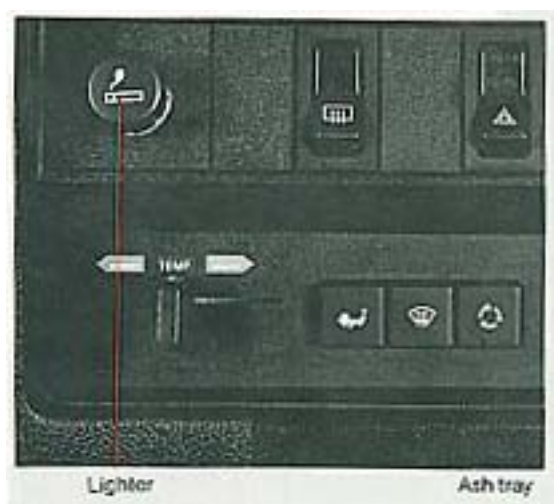

### Cigarette lighter

To operate, depress the knob fully. When the knob automatically releases, the cigarette lighter is ready for use.

The starting (ignition) switch must be ON for the cigarette lighter to function.



### Ash trays

To remove the ash trays depress the center spring and remove.

pg. 21 Electrically operated windows

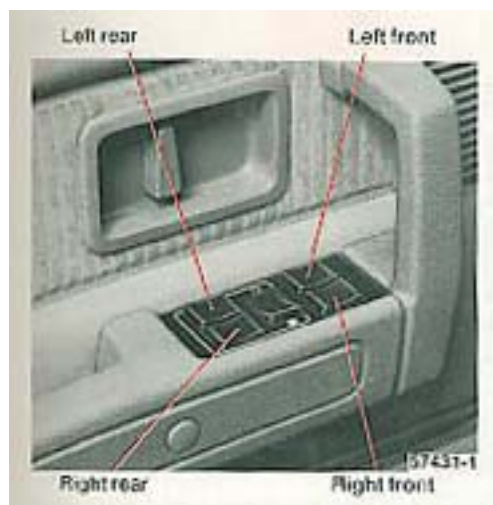

### Electrically operated windows (standard on certain models)

The electrically-operated windows are controlled by switches set in the door arm rests. All the windows can be controlled from the driver's arm rest as shown in the above illustration.

The starting (ignition) switch must be ON for the electrically-operated windows to function. The window is lowered if the rear part of the switch is pressed and raised if the front part of the switch is pressed.

## **WARNING!**

Remove the starting (ignition) key from the car when children are left alone in the car.



### **Cut-out switch for rear-door electrically-operated windows**

If the car is equipped with rear-door power windows, this function can be disabled by a switch located on the driver's door armrest.

This switch is positioned 90° in relation to the other switches.

- The rear door windows can be raised or lowered with the respective door switch on the driver's door.
- The rear door windows **cannot** be raised or lowered with the respective door switch but instead **only** with the corresponding switch on the driver's door.

pg. 22 Heating and ventilation

## **Heating system**

### **1 TEMP**

Left = cool

Right = warm

### **2 FLOOR**

Out = no air to floor

In = full flow of air to front and rear floor

### 3 Defrost

Out = low volume air flow to defroster

In = full flow

### 4 REC (recirculation)

To be used only on cars equipped with air conditioning.

Do not use for heating.



Out = full flow of outside air

In = air is recirculated for faster cooling

### 5 Blower motor

Has 4 speeds and is shut completely off when the knob is turned to the left.

### 6 Air louvers - dash

The air flow through the louvers is decreased when the  and/or  controls are depressed.

### 7 Fresh air louvers - floor (except models with air conditioning)

Lever placed forward = louver opens

Lever placed rearward = louver closes

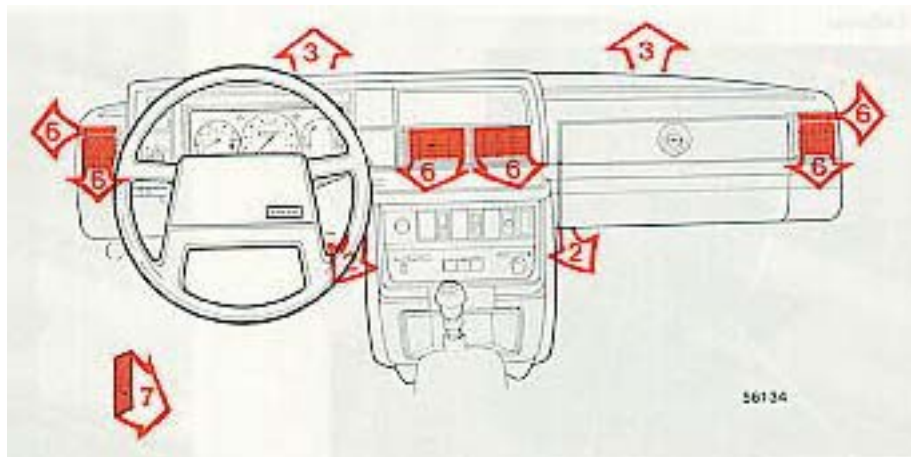



## How to . . .

### . . . obtain max. heat

1 TEMP -> WARM

2  depressed

5 FAN  -> 3(or 4)

6 All dash louvers halfway open and floor air louver closed.

### . . . remove condensation

1 TEMP ->WARM

3 DEF  depressed

5 FAN  -> 3 (or 4)

6 All louvers closed as well as the floor fresh air louver.

Always keep front external inlet grille (in front of the windshield) clear of obstructions (snow, ice, etc.).

### Maximum defroster action

For maximum defroster capacity at very low ambient temperatures, use the recirculation control (button depressed).

If **not** using air conditioning, the recirculation feature should not be used in humid climates and at temperatures about +23°F (-5°C).

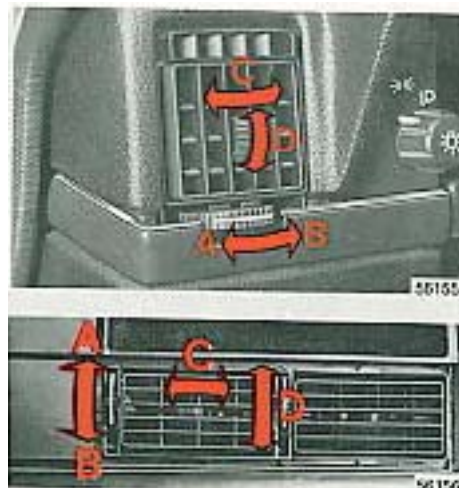

### Air louvers - dash

- A Closed
- B Open
- C Directing air flow horizontally
- D Directing air flow vertically



**Fresh air louver - floor** (except models with air conditioning)

There is a floor-directed fresh air louver on the driver and passenger sides of the vehicle (driver's side only on some models). Airflow is controlled by the lever at the center of the louver.

- Lever placed forward = louver opens
- Lever placed rearward = louver closes

Maximum airflow is obtained with louver fully open and the fan (blower motor) shut completely off. (The fan forces the air through the dash louvers.)



[Contents](#) | [Top of Page](#)



## Air conditioning

Air conditioning (standard on certain models) How to use the air conditioner:

### 1 Fan

Position 4 for rapid cooling.

### 2 AIR COND



Start the air conditioning compressor by turning the control knob clockwise toward MAX.

For rapid cooling, position the knob into the orange range beyond MAX. After desired temperature is reached re-position the control knob into the blue range.

**At cruising speeds, the knob should be kept within the blue range.** If it remains in the orange range, icing may occur resulting in decreased cooling capacity.

### 3 Recirculation

Push in for rapid cooling and during high humidity conditions.

**4 TEMP** To obtain rapid cooling, all windows must be closed and buttons  and  out. Close the floor fresh air louvers.

Cool air will then be discharged through the four dash outlets which should be fully open.

**Note:** For rapid removal of condensation from inside glass surfaces, the air conditioner can be switched on even when not required for interior cooling. The air conditioner will dehumidify the air inside the vehicle.

Have your Volvo dealer check the system for correct operation yearly. The air conditioning system should be operated periodically to ensure trouble-free performance year round.

## pg. 25 Audio systems

### **Operating instructions**

Operating instructions are contained in the manuals associated with each model.

These manuals are placed in the cars when the equipment is installed.

Your Volvo Dealer will be able to assist you with any questions regarding the operation of this equipment.

### **Radio antenna mast**

**Note:** Always lower the antenna mast when entering automatic car wash. The antenna should be cleaned and lubricated every 5,000 miles (8,000 km).

The following information may help to explain differences between car radio reception and radio reception in the home.

#### **Signal sending**

FM waves do not follow the earth's surface and do not bounce against the atmosphere as AM waves do.

#### **Cross modulation**

When receiving a weak signal in the vicinity of another, stronger signal, both stations may be received simultaneously.

#### **Weak reception (fading)**

Because of the limited range of FM senders and the way FM waves spread, this problem usually occurs with FM reception.

Mountains or similar obstacles can sometimes cause disturbances.

#### **Multipath Distortion**

FM Signals are typically "line-of-sight", and very reflective. Their reflectivity to objects such as buildings, mountains, even other passing vehicles, causes the condition known as multipath distortion. This distortion is the result of the reflected signal, and the direct signal reaching your antenna at slightly different times causing a cancellation of all signals. This condition will sound like hissing, or static. Very little can be done to eliminate this problem, however, lowering the treble on your radio could help mask these disturbances thereby allowing you to achieve optimum pleasure from your audio system

## pg. 26 Front seats

### **Driver seat height**

There are two levers, each with three positions, for adjusting the height of the seat (front and/or back of cushion).

This allows adjustment of the seat cushion angle for added comfort.

After adjusting the seat check that it is securely latched.

**Note:** Do not attempt to raise seat height while seated.

### Horizontal seat adjustment

Pull control upward, then slide seat forward or rearward to desired position.

**Make sure that the seat is properly secured when you release the control.**

### **WARNING!**

For your safety, never adjust seat while driving. The seat should be adjusted so that the brake (and clutch) pedal can be depressed fully.

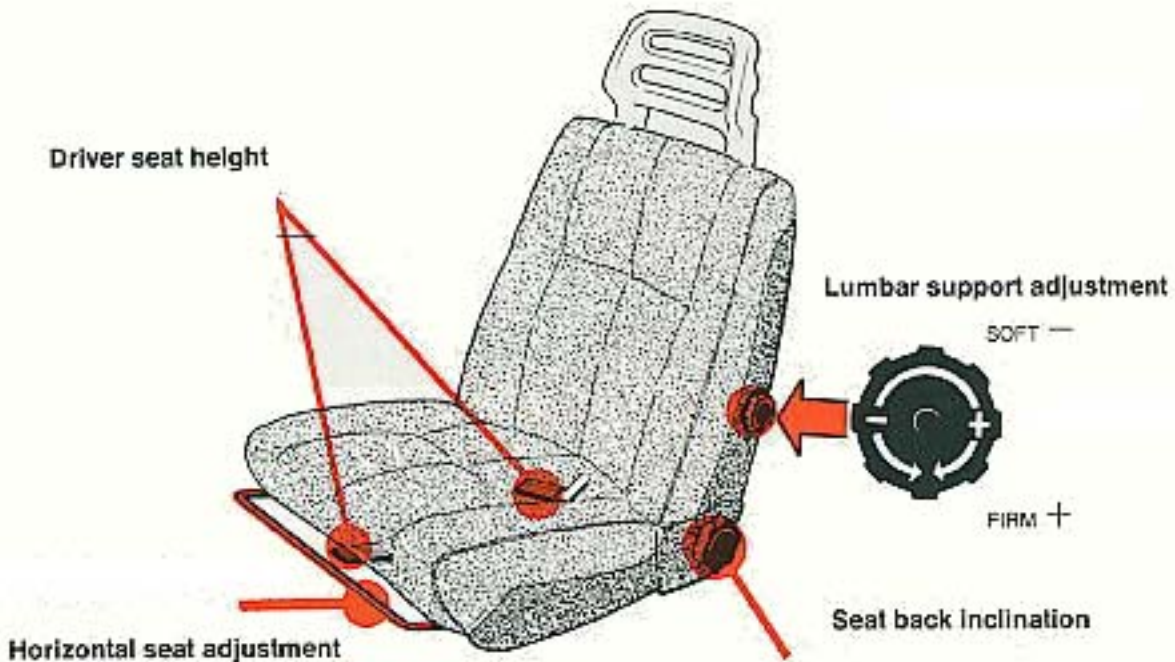

### Passenger seat height

The front passenger seat is retained by four brackets. There are two height positions at the front and three at the rear. However this adjustment must be accomplished manually, using appropriate hand tools.

### Seat back inclination

Rotate control clockwise to tilt seat back rearward. Rotate counterclockwise to tilt seat back forward.

**Note:** Body weight must be shifted to allow seat back to move forward or rearward.

pg. 27 Child safety

### Child safety

Volvo recommends the proper use of restraint systems for all occupants, including children. Remember

that regardless of age and size, a child should always be properly restrained in a car. Restraint systems for children are designed to be secured in the vehicle by lap belts or the lap portion of a lap-shoulder belt. Such child restraint systems protect children in cars in the event of an accident only if they are used properly. However, children could be endangered in a crash if the child restraints are not properly secured in the vehicle. Failure to follow the installation instructions for your child restraint can result in your child striking the vehicle's interior in a sudden stop.

Holding a child in your arms is NOT a suitable substitute for a child restraint system. In an accident, a child held in a person's arms can be crushed between the vehicle's interior and an unrestrained person. The child could also be injured by striking the interior, or by being ejected from the vehicle during a sudden maneuver or impact. The same can also happen if the infant or child rides unrestrained on the seat or in the cargo section of a station wagon. Other occupants should also be properly restrained to help reduce the chance of injuring or increasing the injury of a child.

All states and provinces have legislation governing how and where children should be carried in a car. Recent accident statistics have shown that children are safer in rear seating positions than front seating positions when properly restrained.

A child restraint system can help protect a child in a vehicle. Here's what to look for when selecting a child restraint system:

- It should have a label certifying that it meets applicable Federal Motor Vehicle Safety Standards (FMVSS 213-80) - or in Canada, CMVSS 213.
- Make sure the child restraint system is appropriate for the child's height, weight and development - the label required by the standard or regulation, or instructions for infant restraints, typically provide this information.
- **In using any child restraint system, we urge you to carefully look over the instructions that are provided with the restraint. Be sure you understand them and can use the device properly and safely in this vehicle.**
- A misused child restraint can result in increased injuries for both the infant or child and other occupants in the vehicle.

When a child has outgrown the child safety seat (approximately 4-5 years of age, depending on size) you should use the rear seat with the standard seat belt fastened. The best way to protect the child here is to place the child on a cushion so that the seat lap belt is as far down on the hips as possible. A specially designed and tested safety cushion for this purpose can be obtained from your Volvo dealer.

If necessary, an extra seat is available for use in the luggage compartment of station wagon models. This seat is designed for two children, each up to 80 lbs. in weight and up to 53 inches in height.

**Additional child restraint Information regarding seat anchorage can be found on [page 104](#).**

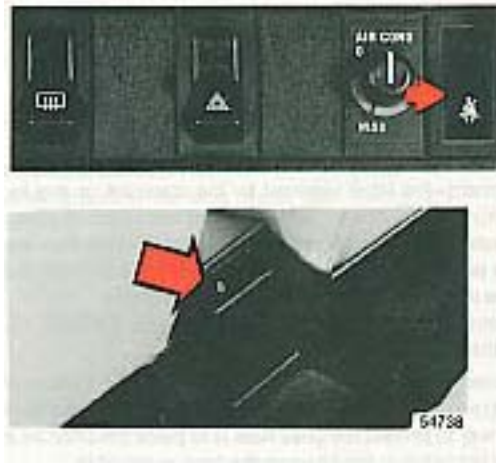

## Seat belts, retractable

### Always fasten the seat belts before you drive or ride.

Two lights will be illuminated for 4-8 seconds after the starting (ignition) key is turned to driving position. One light is located in the instrument cluster and one in the console between the front seats. A chime will sound at the same time if the driver has not fastened his seat belt. The front and rear outboard seats are provided with self-retracting inertia-reel belts.



### To buckle:

Pull the belt out from the retractor far enough to insert the latch plate into the buckle until a distinct snapping sound is heard. The belt should not be twisted or turned.

**Note:** The lap belt should sit low and tight under abdomen.

To unfasten, depress red push-button in buckle and let the belts rewind into their retractors.

Before exiting the car, check that the seat belt retracts fully after being unbuckled. If necessary, guide the belt back into its retractor slot.



The seat belt retractors are normally "unlocked". The retractors will lock up as follows:

- if belt is pulled out rapidly
- during braking and acceleration
- if the vehicle is leaning excessively
- when driving in turns

Check seat belt mechanism function as follows:

1. Attach the seat belt. Pull rapidly on the strap.
- 2.

**WARNING!**

Check other traffic before performing this check.

Brake firmly from approximately 30 mph (50 km/h) or turn in a tight circle while pulling on the belt.

In all the above checks you should not be able to pull the belt out.

pg. 29 Seat belts





**Seat belts, manually adjustable** The center rear seat belt is manually adjustable. It should always be adjusted to the correct length.

**To lengthen**, angle the buckle as shown in the upper illustration and pull the belt through.

**To shorten**, pull the upper part of the double webbing until snug.



The lap belt should sit low under abdomen

### **During pregnancy**

Pregnant women should always wear seat belts. Remember that the belt should always be positioned in such a way as to avoid any possible pressure on the abdomen. The lap belt should be located low, as shown in the above illustration.

### **WARNING!**

Never use any single seat belt for more than one occupant. Never wear the shoulder portion of the belt under the arm or otherwise out of position. Such use could, in event of accident, cause injury. Volvo recommends that all occupants fasten their seat belts.

Aftermarket devices used to induce slack into the shoulder belt portion of Volvo's three-point belt system will have a detrimental effect on the amount of protection available to you in the event of a collision

**Note:** Legislation in your state or province may mandate seat belt usage.

### **Maintenance**

Check periodically that the anchor bolts are secure and that the belts are in good condition. Use water and a mild detergent for cleaning.

**As the seat belts lose much of their strength when stretched, they should be replaced after collision, even though they may appear to be undamaged.**

Never modify or repair the belt on your own. If repair is required, have the work performed by an authorized Volvo dealer.

## pg. 30 Doors and locks, Child safety lock



### **Unlocking front doors**

Both front doors can be unlocked by using the starting (ignition) key. Turning the key 1/4 turn counter-clockwise (right door: clockwise) lifts the lock buttons on the window ledge and the door can be opened by pulling the handle.

To open a door from inside, the lock button must first be pulled up.

In wintertime, if the lock is frozen, be careful not to break the key in the lock. Thaw the ice by heating the lock or the key. Use an electric heater with blower to prevent paint damage when thawing lock.

### **Central lock**

The vehicle is equipped with a central lock system. This means the lock on the driver's door automatically controls the locks on the other doors (including the trunk on Sedan models and the tailgate on the wagon model).

If the driver's door is locked or unlocked, the other doors will automatically be locked or unlocked.

### **Locking doors**

Both front doors can be locked by using the key. Turning the key 1/4 turn clockwise (left door) or counter-clockwise (right door) locks the door.

**NOTE:** The driver's door can only be locked using the key.

**The lock buttons should not be in the down (locked) position during driving. In case of an accident, this may hinder rapid access to the occupants of the vehicle.**

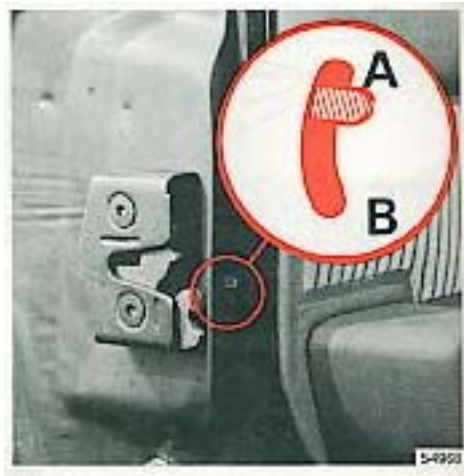

### Child safety locks

The buttons are located on the rear door jambs.

**A** The lock functions normally.

**B** The door cannot be opened from the inside.

### **WARNING!**

In the event of an accident, the rear seat passengers cannot open the doors from the inside with the buttons in position B.

Wagon model contains child safety lock on tailgate. The lock differs from that shown above. See section titled "Wagon, tailgate".

pg. 31 Trunk lid/light



## Trunk lid

The trunk lock is incorporated in the central locking system. This means that you can either lock or unlock the trunk by means of the driver's door lock.

You can also operate the trunk lock directly with the owner's key even if the vehicle is centrally locked.

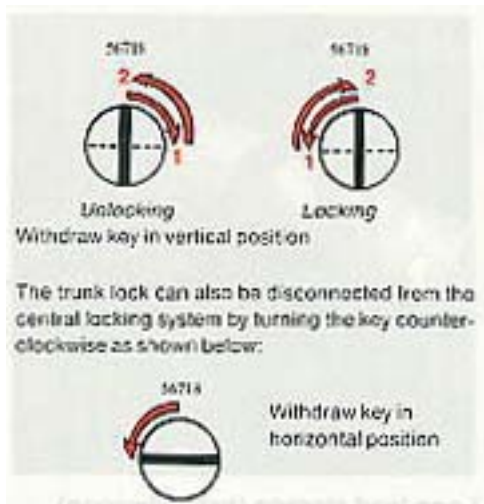

The trunk lock can also be disconnected from the central locking system by turning the key counterclockwise as shown below:

The trunk is now always locked.

This option can be used if for example, you lend your car to somebody. If you give only the service key to the driver it will not be possible to open the trunk.

To reconnect the lock to the central locking system:



## Trunk light

**A** Light always off.

**B** Light on when trunk lid is open.

pg. 32 Hood, Long load storage



**To open the hood**

Pull the release handle (located under the left side of the dash).

Lift the hood slightly, insert a hand under the center line of the hood and depress the safety catch handle.

Open the hood.

**Check that the hood locks properly when closing.**



**Long load storage (except wagon)** A flap in the rear seat makes it possible to carry "long loads" such as skis, etc.

**WARNING!**

When braking rapidly the load could be displaced and cause injury to occupants. Sharp edges on the load should be covered for protection. It is essential that the "load" be secured safely. Use belts locked around the folded down armrest (see illustration).

**WARNING!**

Do not place heavy objects on the rear window shelf. These objects can become dangerous projectiles in the event of sudden braking. Always secure large or heavy objects with the seat belts.

An optional, specially designed, storage bag should also be used to avoid soiling or tearing the upholstery. Please note that the flap in the rear seat is intended only for light loads such as skis, wood etc.

Max. length of load 6 1/2 ft = 2 m.

Max. weight of load 33 lbs = 15 kg.

**WARNING!**

Take care when loading/unloading the vehicle. Always turn off the engine and apply the parking brake. Place automatic transmission gear shift selector in position P (Park). This will prevent accidental movement of the gear shift selector to position D (Drive).

pg. 33 Rear/side view mirrors



**Rear view mirror**

A Normal position

B Night position, reduces glare from following headlights



### Side-view mirrors

A Adjustment up/down

B Adjustment sideways



### Power mirrors

A Adjustment up/down

B Adjustment sideways

Avoid using ice scrapers made of metal as they can easily scratch the mirror surface.

### **WARNING!**

The mirrors should always be adjusted before driving. Objects seen in the wide angle right side view mirror are closer than they appear to be.



### Interior light

1 Light always on.

2 Light always off.

3 Light is on when either of the front or rear doors are opened.

The wagon model has a slightly different kind of interior lamp housing.

On certain models a time delay device illuminates the interior light for approx. 15 seconds after closing the driver's door. This facilitates finding starting (ignition) switch, etc., during darkness.



### Sunroof (certain models)

The sunroof is operated by a handle located between the sun visors.

Unfold the handle and turn it counter-clockwise to open, clockwise to close.

**For safety reasons, the handle should always be folded when driving.**





## Refueling

The fuel tank cap is located behind the door on the right rear fender. Open cap slowly during hot weather.

When filling, position the cap in the special bracket on the door.

After filling the tank, install the cap and turn until a "click" is heard.

The tank holds 15.8 gallons (60 liters).

An optional locking cap is also available.

Refer to section titled "Fuel requirements" for additional information.

pg. 35 Rear seat (wagon)



## Folding rear seat

Depress either lever located at the front bottom edge of the rear seat cushion (right or left side)

**Note:** It may be necessary to move front seat; forward or raise the seat backs slightly to allow rear seat to fold down.



Remove the head restraints from the rear seat by grasping the restraint and lifting straight up. Pull the handle on the rear side of the seat back upwards, and fold the seat back forward and down so that it lies flat. The rear seat back and cushion are held automatically in their respective positions.

**WARNING!**

When returning the rear seat to its normal position, make sure the latches are securely locked and the seat belts are easily accessible for use



**Removing seat cushion**

The seat cushion can be easily removed to provide a slightly larger cargo storage area. To remove, lift the seat cushion out of the hinges.

**WARNING!**

When the rear seat is folded down do not place heavy objects against the backs of the front seats. This places a severe strain on the folded down backrest of the rear seat. Do not load luggage higher than the seat backs to avoid luggage being thrown forward in the event of sudden braking and causing injury to passengers.

pg. 36 Tailgate (wagon)



**To open from the outside**

Depress the release button located under the tail gate handle



**To open from the inside**

Pull out the T-handle located at the bottom of the, tailgate.



### Safety catch

A The lid cannot be opened from the inside.

B The lock functions normally.

pg. 37 Cargo compartment (wagon)



### Spare wheel, jack

The spare wheel and jack are stored under the hatch to the left in the cargo compartment.

Loosen the two clips 1/4 turn and lift off the hatch.

### **WARNING!**

Unless the station wagon is equipped with a cargo compartment seat (Volvo accessory), occupants should not ride in this section of the car



### **Concealed storage space**

There are two concealed storage areas under the cargo compartment floor.

### **Locking floor lid**

The larger lid is lockable and should be used when increased security for stored articles is desirable.



### **Eyelets**

Six eyelets are provided in the cargo compartment for anchoring cargo.

Four eyelets are shown in the illustration. The remaining two are accessible when the seat back is folded forward.

**Note:** The eyelets are not to be used as occupant restraints.

### **WARNING!**

Luggage or other cargo should not be stowed higher than the seat backs. All items should be secured in place.



[Contents](#) | [Top of Page](#)

# 1989 VOLVO 240

## Operating the car

pg. 39 Operating the car

[Service inspection](#) [40](#)

[Break-in period](#) [40](#)

[Driving economy, shift indicator light](#) [41](#)

[Starting the engine](#) [42](#)

[Manual transmission](#) [43](#)

[Automatic transmission](#) [44](#)

[Emergency towing](#) [46](#)

[Towing information](#) [47](#)

[Trailer hauling](#) [48](#)

[Automatic transmission, brake  
system](#) [49](#)

[Catalytic converter](#) [50](#)

pg. 40 Break-in period, Service inspection

## A new car should be broken-in!

### Manual transmission

During the break-in period do not exceed the following speeds\*

## **First 600 miles (1,000 km)**

1st gear 20 mph (30 km/h)  
2nd gear 30 mph (50 km/h)  
3rd gear 50 mph (80 km/h)  
4th gear 70 mph (110 km/h)  
5th gear 80 mph (130 km/h)

## **600-1,200 miles (1,000-2,000 km)**

1st gear 25 mph(40 km/h)  
2nd gear 40 mph (65 km/h)  
3rd gear 60 mph (100 km/h)  
4th gear 80 mph (130 km/h)  
5th gear 90 mph (150 km/h)

Avoid driving at low speed in high gear.

\* These are the maximum speeds recommended by the factory. Note that legislation in different countries and states can stipulate other max. speeds than those given here.

## **Automatic transmission**

Do not depress the accelerator to the extent that "kick-down" is actuated during the first 1,200 miles (2,000 km) when driving a car equipped with an automatic transmission.

## **Breaking in parking brakes**

To obtain best parking brake performance, the brake linings should be broken in. Stop 5-7 times from 30 mph (50 km/h), transmission in neutral, applying the parking brake with the release button pressed in during the stop. The force must not lock the rear wheels. If this happens, release the brake enough to let the wheels rotate. Drive a mile between each stop to cool the brakes. Check for proper parking brake operation.

**Note:** The brake lights are not illuminated when applying the parking brake. To warn traffic from behind it is therefore advisable to depress the brake pedal slightly to illuminate the brake lights.

## **600-1,200 mile maintenance service**

To ensure proper operation the car should be taken to a Volvo dealer between the first 600-1,200 miles (1,000-2,000 km) for a maintenance service. The oil in the engine, manual transmission and rear axle will then be changed. This is very important since the oil rapidly collects impurities during the break-in period.



**Economical driving does not necessarily mean driving slowly**

Better driving economy may be obtained by thinking ahead, avoiding rapid starts and stops and adjusting the speed of your vehicle to immediate traffic conditions. Observe the following rules:

- Bring the engine to normal operating temperature as soon as possible by driving with a light foot on the accelerator pedal instead of allowing the engine to idle for a prolonged period. A cold engine uses more fuel and is subject to increased wear.
- When possible avoid using the car for driving short distances. This does not allow the engine to reach normal operating temperature.
- Drive carefully and avoid rapid acceleration and hard braking.
- Do not exceed speed limit.
- Avoid carrying unnecessary items (extra load) in the car.
- Check tire pressures regularly (cold tires).
- Remove snow tires when threat of snow or ice has ended.
- Note that roof racks, ski racks, etc., increase air resistance and thereby fuel consumption.
- Avoid using automatic transmission kick-down feature unless necessary.

Other factors which decrease gas mileage are:

- Worn or dirty spark plugs
- Incorrect spark plug gap
- Dirty air filter
- Incorrect valve clearance
- Incorrect idle speed
- Dirty engine oil and clogged oil filter
- Dragging brakes
- Incorrect front end alignment
- Low tire pressure

**Shift indicator light****(manual transmission models only)**

The Volvo shift indicator light (S.I.L.) is a device designed to help you get even better gas mileage from your Volvo car. Studies have shown that the best fuel economy is obtained by shifting gears at low engine rpm and high relative engine load. The Volvo S.I.L. is calibrated to show you when to shift for improved mileage without sacrificing smooth acceleration.

Use of the S.I.L. is simple. Shift to next higher gear as soon as the light comes on. You may find after using the S.I.L. for some time that your natural shifting rhythm will adapt to the S.I.L.'s suggestion. Some drivers may even shift before the light comes on.

Obviously, there will be times when you need to shift later than the light would indicate (for example, when climbing hills or trailer towing). Using the light regularly, however, should result in a mileage

improvement of six percent or more, depending on how you normally drive.

### **Programming instructions for shift indicator**

If the current supply to the control unit is cut (battery disconnected), the control unit will have to be re-programmed as the control unit memory will be erased.

Drive the car in each gear (first gear not necessary) for approximately 8 seconds. The gear change indicator light will flicker once (0.5 seconds), as each gear is programmed.

**Note:** Remove foot completely from the clutch pedal after each gear change when programming the control unit.

## pg. 42 Starting the engine

### **To start the engine;**

1 Enter the car and check that the seat is adjusted properly. Make sure that the brake (and clutch) pedal can be depressed completely. Move the seat closer if necessary.

2 Fasten the seat belt.

3 Apply the parking brake if not already set. Depress the brake pedal with your right foot.

4 Place the gear selector lever in neutral (position N or P, automatic transmission).

5 Depress the clutch pedal (manual transmission).

6 Without touching the accelerator pedal turn the ignition key to starting position. Release the key as soon as the engine starts. Avoid repeated short attempts to start (fuel is injected every time the starter is engaged when engine is cold).

Allow the starter to operate for a longer time (but not more than 15-20 seconds).

**Do not race a cold engine immediately after starting.**

### **Engine warm-up - initial driving procedure**

Experience shows that engines in vehicles driven short distances are subject to abnormally rapid wear because the engine never reaches normal operating temperature.

It is therefore beneficial to reach normal operating temperature as soon as possible by driving with a light foot on the accelerator pedal.

**WARNING!**

Always open the garage doors fully before starting the engine inside the garage to ensure adequate ventilation. The exhaust gases contain carbon monoxide, which is invisible and odorless but very poisonous.

pg. 43 Manual transmission

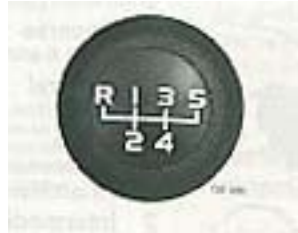
**5-speed manual transmission**

Depress the clutch pedal fully when changing gears.

Remove the foot from the clutch pedal after every gear shift.

See "Shift indicator light" section for more information on economical use of the manual transmission.

Recommended minimum and maximum speeds for each gear are listed in the specification section.

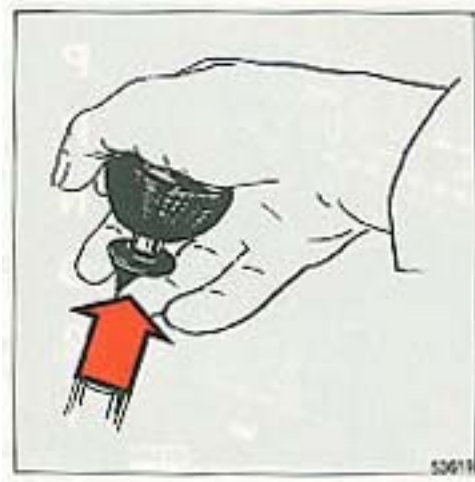
**Reverse gear (R)**

The detent collar on the gear shift lever must be lifted prior to engaging reverse gear. This prevents inadvertent selection of reverse gear

pg. 44 Automatic transmission

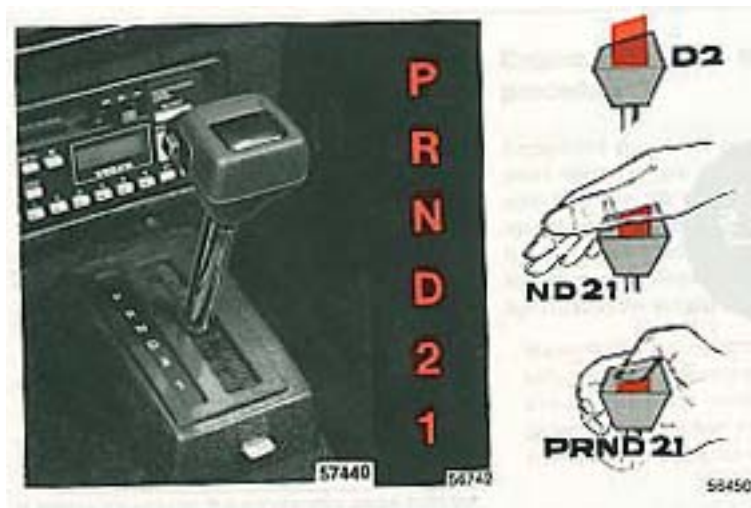

## Shift positions

- P park
- R reverse
- N neutral
- D drive
- 2 intermediate
- 1 low

The gear selector can be moved freely between D and 2. Selections of other positions are obtained by depressing the selector knob prior to moving the selector.

Depressing the selector knob slightly allows selection of positions **N** and **1**.

Depressing the selector knob fully allows selection of positions **R** and **P**. This is also necessary when initially bringing the selector out of position **P**.

Depressing the selector knob fully thus permits shifting freely between all positions.

### **P Park**

Use this position when parked with the engine running or stopped.

**Never use P while car is in motion.**

The transmission is mechanically locked in position P. Also use the parking brake when parking on grades for added safety.

### **R Reverse**

**Never use R while car is moving forward.**

### **N Neutral**

Neutral position = no gear is engaged. Use parking brake.

### **D Drive**

D is the normal driving position. Upshift and downshift of the forward gears occurs automatically and is governed by acceleration and vehicle speed.

### **2 Intermediate position**

Upshift and downshift of first two gears (low and intermediate) occurs automatically.

**No** upshift to 3rd (top) gear occurs. Position 2 may be used to obtain forced downshift to 2nd gear for

increased engine braking effect. Position 2 can also be used...

- for relatively slow highway driving.
- for city driving.
- when driving on mountain roads where precise speed control is desirable.
- for passing.

### 1 Low position

If position 1 is selected when driving at high speeds, 2 is engaged first and 1 when the speed has dropped to approx. 30 mph (50 km/h).

**NOTE:** No upshift once 1 is engaged.

Use position 1 to select low gear with no upshift. Use for instance, when ascending and descending steep grades.

---

### CAUTION:

- **Never select P or R while the car is in motion.**
- **When initially selecting D,2,1 or R, your right foot should press firmly on the brake and the engine must be idling.**
- **Never downshift to 2 or 1 at speeds above 75 mph(125km/h)\*.**

\*Always observe local speed limits!

pg. 45 Automatic transmission



### Disengaging 4th gear

The transmission will engage 4th gear automatically after upshifting through first, second and third gears unless the disengagement button on the side of the gear selector knob is pushed.

When the button is pushed to disengage 4th gear, the transmission operates as a 3-speed unit. If the button is pushed while 4th gear is engaged, then a downshift to 3rd gear will occur. The transmission, then, cannot upshift to 4th gear until the button is pushed again. As a reminder, when 4th gear is disengaged, the indicator light (  ) in the instrument panel is illuminated. Be aware that, if 4th gear is disengaged (reminder light illuminated) when the engine is switched off, the transmission will revert automatically to 4-speed operation (reminder light not illuminated) when the engine is restarted.

Disengage 4th gear (reminder light illuminated) when:

- \* towing a trailer
- \* driving on hilly roads where precise speed control is desired.

### **Kick-down**

Automatic shift to a lower gear is achieved by depressing the throttle pedal fully and briskly.

An up-shift will be achieved when approaching the top speed for a particular gear or by releasing the throttle pedal slightly.

Kick-down can be used for maximum acceleration or when passing at highway speeds.

### **Starting and stopping a car equipped with automatic transmission**

1. Enter the car and check that the seat is adjusted properly. Make sure that the brake (and clutch) pedal can be depressed completely. Move the seat closer if necessary.
2. Fasten the seat belt.
3. Apply the parking brake if not already set. Depress the brake pedal with your right foot.
4. Place the gear selector in Park (or neutral).
5. Without touching the accelerator pedal, turn the ignition key to the starting position. Release the key as soon as the engine starts.
6. Select the desired gear. There is a slight delay before the gear engages which is most noticeable when selecting Reverse. Do not accelerate until you have felt the gear engage!

**Note:** Too-rapid acceleration immediately after selecting a gear will cause harsh engagement and premature transmission wear.

7. Release parking brake, then foot brake, and accelerate. To stop the car release the accelerator and apply the brakes with your right foot.

It is not necessary to move the gear selector as the transmission will downshift automatically.

When idling for extended periods of time, select position N to prevent unnecessary heating of the transmission.

### **WARNING!**

Always place gear selector in Park and apply parking brake before leaving vehicle. Never leave car unattended with engine running.

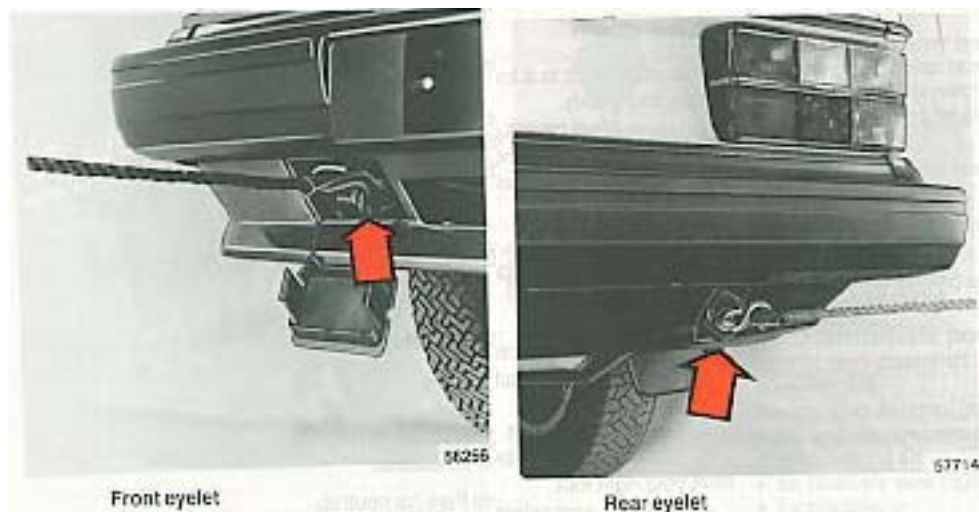

### Precautionary steps to observe when towing

Please check with state and local authorities before attempting this type of towing as vehicles being towed are subject to regulations regarding maximum towing speed, length and type of towing device, lighting, etc.

- Steering must be unlocked.
- Remember that power brake and power steering assists will not be available when engine is inoperative. Pedal pressure required is 3—4 times above normal and greater steering effort must be employed.
- Towing cars equipped with automatic transmission:
  - Gear selector in position N. Check transmission oil level (see section titled "Transmission oil").
  - Maximum speed: 20 mph (30 km/h).
  - Maximum distance with rear wheels on ground: 20 miles (30 km).

### CAUTION!

Do not attempt to start the car by pushing or pulling as damage to catalytic converter can result.

**Jump starting, see section titled "alternator, jump starting"**

**NOTE:** Refer to the section regarding "On-Call"

pg. 47 Tow-truck information

**Only use wheel lift or flat bed equipment.**

**CAUTION:**

Sling-type equipment applied at the front will damage radiator and air conditioning lines. It is equally important not to use sling-type equipment at the rear or apply lifting equipment inside the rear wheels: serious damage to the rear axle may result.

pg. 48 Trailer hauling

**When preparing for trailer hauling, observe the following:**

- Use a trailer hitch which meets Federal Safety Standards for rear end collisions (FMVSS 301-75). For trailer weights exceeding 2,000 lbs (908 kgs) use only a trailer hitch offered as a Genuine Volvo Accessory.
- Maximum trailer weight recommended by Volvo is 3,300 lbs (1,500 kg). However, for cars with **automatic transmission**, an optional Volvo automatic transmission oil cooler must be installed when trailer weight exceeds 2,000 lbs (908 kgs). With manual transmission, **5th gear should not be used while towing**. Observe legal requirements of the state in which the vehicles are registered.

All Volvo models are equipped with energy absorbing shock mounted bumpers. Trailer hitch installation should not interfere with the proper operation of the bumper system.

**WARNING!**

Bumper-attached trailer hitches must not be used on Volvos, nor should safety chains be attached to the bumper. Trailer hitches attaching to the vehicle rear axle must not be used.

**WARNING!**

Never connect a trailer's hydraulic brake system directly to the vehicle brake system, nor a trailer's lighting system directly to the vehicle lighting system. Consult your nearest authorized Volvo dealer for correct installation.

Trailer hauling does not normally present any particular problems, but take into consideration:

- Recommended hitch tongue load is 110 lbs (50 kgs) for trailer weights below 2,650 lbs (1,200 kgs) and 143-154 lbs (65-70 kgs) for trailer weights above 2,650 lbs (1,200 kgs). However, it must not exceed 200 lbs (90 kgs).
- For trailer weights between 2,650-3,300 lbs (1,200-1,500 kgs) a top speed of 50 mph (80 km/h) should never be exceeded.
- Engine and transmission are subject to increased loads. Therefore, engine coolant temperature should be closely watched when driving in hot climate or hilly terrain. Use lower gear and turn off air



conditioner if temperature gauge pointer enters the red range.

- Avoid overload and other abusive operation.
- Hauling a trailer affects handling, durability and economy. Trailer air dam (Volvo accessory) will improve mileage.
- It is necessary to balance trailer brakes with the towing vehicle brakes to provide a safe stop (check and observe State regulations).
- More frequent vehicle maintenance is required.
- Remove the ball and drawbar assembly when the hitch is not being used.
- Increase tire pressure to recommended full-load pressure See section "Wheels and Tires"

**Note:** Refer to section entitled "Automatic transmission" for additional trailer hauling tips.

**WARNING!**

Do not drive with trunk lid or tailgate open!

Poisonous exhaust gases may enter via the open trunk lid or tailgate. (This is especially true for wagon models.) If the trunk lid or tailgate for any reason must be open, proceed as follows:

- Close the windows.
- Set the heating system controls for floor and defroster to max. and the blower to full speed (4). See section titled "Heating and Ventilation".

**Handling, roadholding**

Vehicle load, tire design and inflation pressure are important for proper handling. Therefore check that the tires are inflated to the recommended pressure according to the vehicle load. Loads should be distributed so that capacity weight or maximum permissible axle loads are not exceeded.

It is recommended to use tires of the same make and dimensions on all four wheels.

**WARNING!**

Do not mix radial ply and bias ply tires as this will adversely alter the vehicle handling characteristics.

**Roof rack**

Permanent and removable roof racks are available from Volvo Accessories. Observe the following points when in use.

- Avoid point loads. Distribute the load evenly.
- Place the heavy cargo at bottom of load.
- Observe that center of gravity and handling are influenced by the load weight.

- Increasing load size increases wind resistance.
- Anchor the cargo correctly with a cord.
- Drive carefully. Avoid rapid starts, heavy cornering and heavy braking.
- Max. roof load is 220 Lbs (100 kg); use a roof rack with a sufficient load rating.

## pg. 49 Automatic transmission, Brake system

### **The following "Special Tips" apply to cars with automatic transmission**

- For steep hills and when driving for prolonged periods at low speeds, position 1 should be selected. Avoid, however, repeated changes since this can cause overheating of the transmission oil. For driving on mountain roads with long persistent uphill gradients, select position 2.
- When negotiating long, steep, downhill slopes, position 1 should be selected and position 2 for less severe inclines, in order to obtain the best possible engine braking effect.
- Do not hold the car stationary on an incline by using the accelerator pedal. Instead, engage the handbrake. This prevents the transmission oil from becoming overheated.
- 4th gear must be disengaged when hauling a trailer!
- If an additional transmission oil cooler is installed you can haul a trailer with the overdrive engaged. See next "special tip".
- When driving with heavy trailers, it is recommended that an additional oil cooler be installed. This applies especially when driving under severe conditions e.g. mountain driving or prolonged driving at high speeds without breaks. The additional oil cooler is available as a genuine Volvo accessory. Regarding oil change, see section titled "Transmission oil".

### **Moisture on brake discs and brake pads affects braking.**

Driving in rain and slush or passing through a normal car wash can cause water to collect on the brake discs and pads. This will cause a delay in braking effect when the pedal is depressed. To avoid such a delay, when the brakes are needed, depress the pedal occasionally when driving in rain or slush. This will remove the water from the brakes. This should also be done after washing or starting in very damp weather.

### **If the brake power assist does not function-**

**The power assist to the brakes functions only when the engine is running.** When the car is moving without the engine running the brake pedal pressure required to stop the car is increased 3 - 4 times.

### **The brake pedal feels stiff and hard.**

**Disc brake noise:** A slight-to-moderate amount of disc brake "squeal" is considered normal.

### **Air dam (front spoiler)**

A non-factory air dam can negatively influence the normal flow of cooling air to the front wheel brakes. (See section titled "Wheels and Tires").

### **If one of the brake circuits should malfunction the red warning light will come on**



(See section titled "Warning Lights".)

The pedal stroke increases slightly and the pedal feels softer but the pedal pressure required does not increase noticeably.

If the light comes on while driving and the brake pedal can be depressed further than normal, it is an indication that one of the brake circuits is not functioning. **Stop immediately, open engine hood and check brake fluid level.**

**Reservoir empty;** do NOT drive. Tow car to shop for check/repair of brake system. **Reservoir not empty:** proceed immediately and with **caution** to a Volvo dealer for an inspection of the brake system.

### Severe strain on the brake system.

The brakes will be subject to severe strain when driving in mountains or hilly areas. The speed is usually low which means that the cooling of the brake is less efficient than when driving on level roads.

To reduce the strain on the brakes it is advisable not to use the brakes excessively.

Instead, shift into a lower gear and let the engine help with the braking. A good rule is to use the same gear downhill as would be used ascending the same grade. For vehicles with automatic transmission use position 2, or in some cases, 1.

pg. 50 Catalytic Converter

### Catalytic Converter Cautions

(all U.S.A. and certain Canadian models)

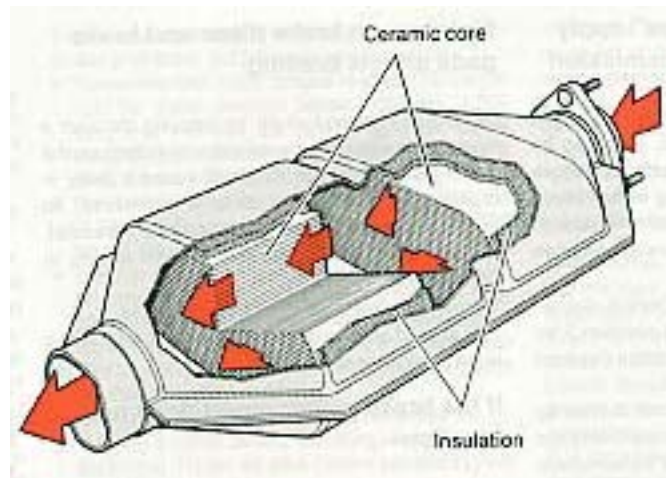

- Keep your engine properly tuned. Certain engine malfunctions, particularly involving the electrical, fuel or ignition systems, may cause unusually high converter temperatures. Do not continue to operate your vehicle if you detect engine misfire, noticeable loss of power or other unusual operating conditions, such as engine overheating or backfiring. A properly-tuned engine will help in avoiding malfunctions that could damage the Catalytic Converter.
- Remember that tampering with or unauthorized modifications to the engine or the vehicle may be

illegal and can cause catalyst or exhaust system overheating. This includes: Altering fuel injection settings or components. Adjusting ignition timing beyond specified limits.

Altering emission system components or location or removing components. Repeated use of leaded fuel.

- Do not park your car over combustible materials, such as grass or leaves, which can come into contact with the hot exhaust system and cause such materials to ignite under certain wind and weather conditions.

- Excessive starter cranking (in excess of one continuous minute) with an intermittently firing or flooded engine, can cause catalyst or exhaust system overheating. This also applies to lengthy pushing or towing of vehicle to start (manual transmissions only). Do not attempt to start a car with automatic transmission by pushing or towing.

**NOTE: Unleaded fuel is required for cars with catalytic converter. A label on the instrument panel and rear fender, near the filler inlet, will remind owners and filling station attendant of this requirement. Important! It is unlawful to dispense leaded fuel into any vehicle labeled "unleaded gasoline only".**



[Contents](#) | [Top of Page](#)

---

# 1989 VOLVO 240

## Service and maintenance

pg. 51 Service and maintenance

<u>Maintenance services</u>	<u>53</u>
<u>Service requirements</u>	<u>54</u>
<u>Engine B230F</u>	<u>56</u>
<u>Road assistance</u>	<u>57</u>
<u>Fuel requirements</u>	<u>58</u>
<u>Engine fluids</u>	<u>59</u>
<u>Engine oil, Oil/oil filter change interval</u>	<u>60</u>
<u>Cooling system</u>	<u>61</u>
<u>Servicing</u>	<u>63</u>
<u>Transmission oil</u>	<u>68</u>
<u>Rear axle, power steering, brake fluid</u>	<u>70</u>
<u>Lubrication</u>	<u>71</u>
<u>Coolant</u>	<u>72</u>
<u>Alternator, jump starting</u>	<u>73</u>
<u>Replacing bulbs</u>	<u>74</u>
<u>Fuses</u>	<u>79</u>
<u>Wheels and tires</u>	<u>80</u>
<u>Wheel changing</u>	<u>82</u>
<u>Replacing wiper blades</u>	<u>84</u>
<u>Washing, cleaning</u>	<u>85</u>
<u>Cleaning, anti-rust treatment</u>	<u>85</u>
<u>Paint touch-up</u>	<u>86</u>
<u>Long distance trips, cold weather</u>	<u>89</u>
<u>Service diagnosis</u>	<u>90</u>
<u>Label information</u>	<u>94</u>



## MAINTENANCE

### Maintenance services

Your Volvo has passed two major inspections before it was delivered to you, according to Volvo specifications. When driven 600-1,200 miles (1,000-2,000 km), your car should be brought to the Volvo dealer for a maintenance service. Engine, manual transmission and rear axle oils, will be changed at this time.

**Following this inspection, maintenance inspections as outlined in this book should be performed every 5,000 miles (8,000 km).**

**Engine oil and oil filter changes should be performed every 5,000 miles (8,000 km), or at the time intervals outlined on page 60.**

The extended maintenance inspection intervals make it even more advisable to follow this program.

Inspection and service should also be performed any time a malfunction is observed or suspected. It is recommended that receipts for vehicle emission services be retained in the event questions arise concerning maintenance. See your "Warranty Information and Maintenance Records Booklets"

### Maintenance inspection intervals

Volvo advises you to follow the inspection program at 5,000 mile or 8,000 km intervals which is outlined in the "Warranties and Maintenance Records Manual". This maintenance program contains inspections and services necessary for the proper functioning of your car over the next inspection interval.

The maintenance inspections contain several checks which require special instruments and tools and therefore must be performed by a qualified technician.

To keep your Volvo in top condition, specify time tested and proven Genuine Volvo Parts and Accessories.

### THE FEDERAL CLEAN AIR ACT (USA)

The Clean Air Act requires vehicle manufacturers to furnish written instructions to the ultimate purchaser to assure the proper functioning of those components that control emissions.

The maintenance instructions listed in the "Servicing" section of this Manual represent the minimum maintenance required. These services are not covered by the warranty. You will be required to pay for labor and material used. Refer to your "Warranties and Maintenance Records Manual" for further details.

In accordance with Federal Regulations, your Volvo is warranted to meet certain Emission Performance Standards. Refer to your Warranty Information Manual for detailed information concerning:

- Emissions Performance Warranty (USA)
- Limited 5-Year/50,000-Mile Emission System Warranty (USA)
- 5-Year/80,000-Kilometer Emission System Warranty (Canada)

**A**= Adjust (Correct if necessary)  
**R**= Replace  
**I**= Inspect (Correct or Replace if necessary)  
**L**= Lubricate

Maintenance Operation	Miles	600-1,200	5,000	10,000	15,000	20,000	25,000	30,000	35,000	40,000	45,000	50,000	55,000	60,000 <sup>2</sup>
	(Km)	(1,000-2,000)	(8,000)	(16,000)	(24,000)	(32,000)	(40,000)	(48,000)	(56,000)	(64,000)	(72,000)	(80,000)	(88,000)	(96,000)
<b>EMISSION SYSTEM MAINTENANCE</b>														
Engine oil and Oil filter <sup>1</sup>	R	R	R	R	R	R	R	R	R	R	R	R	R	R
Cooling System Hoses and Connections <sup>4</sup>	I													
Engine Drive Belts	A							I						I
Torque Manifold Nuts	A													
Valve Clearance								I						I
Timing Belt	A											R <sup>3</sup>		
Vacuum Fittings, Hoses and Connections <sup>4</sup>	I													
Air Cleaner Filter								R						R
Idle RPM	I													
Fuel System Cap, Tank, Lines and Connections <sup>4</sup>	I <sup>3</sup>													
Spark Plugs								R						R
Catalytic Converter Mounting Bolts	A													
Manual Transmission Oil <sup>5</sup>	R	I	I	I	I	I	I	I	I	I	I	I	I	I
Automatic Transmission Oil <sup>5</sup>	I	I	I	I	R	I	I	I	R	I	I	I	I	R
Rear Axle Oil <sup>5</sup>	R	I	I	I	I	I	I	I	I	I	I	I	I	I

- 1) See section in Owner's Manual for "Engine Oil" for detailed information
- 2) For services beyond 60,000 miles (96,000 km), consult your Maintenance Service Chart.
- 3) Recommended, but not mandatory to maintain Volvo emission warranty.
- 4) Does not pertain to B230F/Renix, B230F/EGR.
- 5) B230F/Renix, B230F/EGR inspect every 10,000 miles (16,000 km).

**1989**  
**MAINTENANCE SCHEDULE**  
**240**

**A**= Adjust (Correct if necessary)  
**R**= Replace  
**I**= Inspect (Correct or Replace if necessary)  
**L**= Lubricate

<b>Maintenance Operation</b>	<b>Miles</b>	600-1,200	5,000	10,000	15,000	20,000	25,000	30,000	35,000	40,000	45,000	50,000	55,000	60,000 <sup>1</sup>
	<b>(Km)</b>	(1,000-2,000)	(8,000)	(16,000)	(24,000)	(32,000)	(40,000)	(48,000)	(56,000)	(64,000)	(72,000)	(80,000)	(88,000)	(96,000)
<b>MISCELLANEOUS MAINTENANCE</b>														
<b>ENGINE</b>														
Engine Coolant	I		I		I		R		I		I		R	
Fuel (Line) Filter														R
PCV Nipple (Orifice)														I
Ventilation Hoses														I
<b>BRAKES</b>														
Inspect Brakes. Replace components as necessary.			I		I		I		I		I		I	
Change Brake Fluid							R							R
<b>STEERING</b>														
Tire Wear (Align front end if needed.)	I		I		I		I		I		I		I	
Check power steering fluid level.	I	I	I	I	I	I	I	I	I	I	I	I	I	I
<b>BODY</b>														
Trunk, Door and Hood Hinges and Latches.	L		L		L		L		L		L		L	

1) For services beyond 60,000 miles (96,000 km), consult your Maintenance Service Chart.

## pg. 56 Service Engine

The following items should be checked wee by the owner. (This only takes a few moments.)

Engine oil level

Brake fluid

Radiator coolant level

Tire pressures (including spare)

Operation of all lights

Horns

Windshield wipers

Level of windshield fluid

The following should also be carried out regular intervals.

Washing

Polishing

Cleaning

Rust protection inspection

Description on page

[59](#)

[70](#)

[72](#)

[80, 101](#)

-

-

-

Description on page

[84](#)

[85](#)

[85](#)

[85](#)

## pg. 57 Service Engine



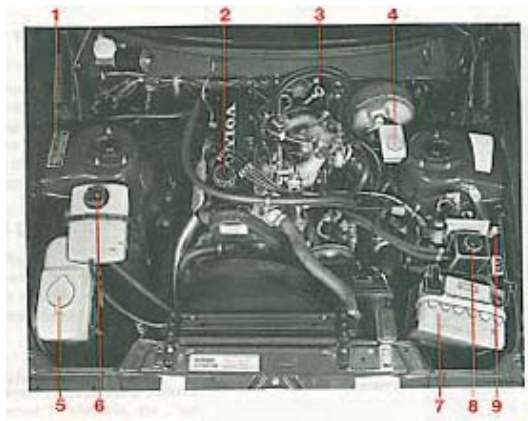

### Engine B230F

- 1 Data plate
- 2 Oil filler cap, engine
- 3 Oil dipstick, engine
- 4 Brake fluid reservoir
- 5 Washer fluid reservoir
- 6 Expansion tank, coolant
- 7 Oil reservoir, power steering
- 8 Battery
- 9 Fuse engine control

pg. 58 Fuel requirements

### Unleaded Fuel

Each Volvo has a catalytic converter and must use only unleaded gasoline (as specified on the instrument panel and by a label near the filler inlet). U.S. and Canadian regulations require that pumps delivering unleaded gasoline be labeled "UNLEADED". Only these pumps have nozzles which fit your car's filler inlet. It is unlawful to dispense leaded fuel into a vehicle labeled "unleaded gasoline only".

Leaded gasoline damages the catalytic converter and the oxygen sensor system. Repeated use of leaded gasoline will lessen the effectiveness of the emission control system and could result in loss of emission warranty coverage. State and local vehicle inspection programs will make detection of misfueling easier, possibly resulting in emission test failure for misfueled vehicles.

### Octane Rating

Volvo engines require unleaded gasoline with an (R+M)/2 octane rating (also called the Anti Knock Index, or AKI) of 87 or higher. This is generally equivalent to a Research Octane Number (RON) of 91 or higher. Volvo recommends the use of premium unleaded gasoline with an (R+M)/2 rating of 91, for improved performance and driveability at high altitudes and in hot climates.

### Detergent or Injector Cleaning Gasoline

The use of specially formulated gasoline which contains so called "detergent" or "injector cleaning" additives is allowed and recommended by Volvo. The use of these detergent additives in gasoline has been shown to be effective in reducing the build-up of certain injector deposits.

### Gasoline Containing Alcohol

Some fuel suppliers sell gasoline containing alcohol without advertising the presence of alcohol if you are not sure whether there is alcohol in the gasoline you buy, check with the service station operator.

Blends of unleaded gasoline and ethanol (ethyl alcohol, grain alcohol), sometimes called "gasohol", are available in some areas. Gasohol, if used, must contain no more than 10 percent ethanol and must have an (R+M)/2 rating of 87 or higher. If you experience problems with starting, driveability, or fuel economy with gasohol, you should discontinue its use. Take care not to spill gasoline during refueling. Gasolines containing alcohol can cause damage to painted surfaces, which may not be covered under the New Vehicle Limited Warranty.

### Caution:

Do not use gasolines containing methanol (methyl alcohol, wood alcohol). This practice can result in vehicle performance deterioration and can damage critical parts in the fuel system. Such damage may not be covered under the New Vehicle Warranty.

## Fuel Tank

The fuel tank is designed to hold approx. 15.8 US gal. (60 liters), with sufficient volume left over to accommodate possible expansion of the fuel in hot weather.

Be aware that the "usable" tank capacity will be somewhat less than the 15.8-US gal. (60-liter) maximum. When the fuel level is low, such factors as ambient temperature, the fuel's "vapor pressure" characteristics, and terrain can affect the fuel pumps' ability to supply the engine with an adequate supply of fuel. Therefore, it is advisable to refuel as soon as possible when the needle nears the red zone. After the needle enters the red zone, you should be able to drive approx. 25 miles (40 km) depending on driving style and conditions.

pg. 59 Engine fluids

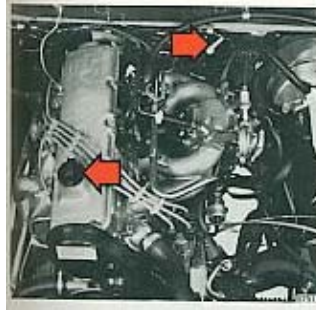

## Checking oil level

The oil level should be checked each time the fuel tank is refilled. Be sure the oil level is maintained between the upper and lower marks on the dipstick. Low oil level can cause internal damage to the engine and overfilling can result in high oil consumption. The distance between the dipstick marks represents approx. 1 quart (1 liter) of oil.

## Changing oil filter

Replace the oil filter at every oil change. If the oil filter is changed separately 1/2 US qt = .5 liters of oil should be added.

## To add oil or change oil

engine oil of the same kind as already used. See engine oil section.

## Coolant

Maintain fluid level between MAX and MIN marks on expansion tank.

Mixture of 50 percent Volvo anti-freeze type C (blue-green) or corresponding and 50 percent water should be used. See "Coolant" section.

## Brake fluid

Check that the level is above the MIN mark, without removing the cap.

Brake fluid DOT 4. See "Brake fluid" section.

## Battery

Check level in conjunction with normal service or once a year. Electrolyte level 1/4 - 1/2 (5-10 mm) above plates Use distilled water. **Never add acid.**

### WARNING!

Battery gases are explosives if brought in contact with open flame or sparks.



### Washer fluid

Washer fluid reservoir.

Water and solvent (wintertime use windshield washer anti-freeze). See "Washer fluid reservoir" section.

pg. 60 Engine Oil, 5,000 mile (8,000 km) Oil/oil filter change interval

### Oil quality

Meeting API specification SF (CCMC class G3)

\*Oils with designations SF/CC and SF/CD comply with these requirements

### Viscosity (stable ambient temperatures):

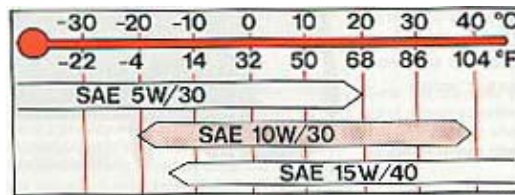

Volvo recommends the use of energy-conserving oils. When using these oils, the Volvo recommended oil-change intervals must be followed. Synthetic or semisynthetic oils may be used if their specifications comply with the oil quality requirements.

**Volvo does not recommend oil additives, as they can adversely affect the engine.**

### Changing oil and oil filter

Oil and oil filter are first changed at the 600-1,200 mile (1,000-2,000 km) service. Thereafter, changes should be made as specified by this table:

### Capacity

**Including oil filter:** 4.0 US qts - 3.85 litres

### Check oil level when filling fuel.

SAE 15W/40 is recommended for use in driving conditions that raise engine temperature and increase oil consumption (i.e., mountain driving; trailer towing).

**Note:** SAE 15W/40 must not be used at low ambient temperatures; see viscosity chart.



Volvo recommends the use of oils with the American Petroleum Institute (API) label.

This label certifies that the oil conforms to the applicable standards and specifications of the API.

**If driving conditions include:**

**Then the correct oil, oil filter change interval is:**

- Extended periods of idling and/ or low-speed operation
- Frequent short trips (less than 7 miles = 11 km)
- Extended periods of driving in dusty and/or sandy areas
- Trailer towing
- Driving mountainous areas

**EVERY  
3 MONTHS  
or 5,000 miles = 8,000 km  
WHICHEVER COMES FIRST**

- Primarily highway driving
- Frequent trips of longer than 7 miles = 11 km

**EVERY 6 MONTHS  
or 5,000 miles = 8,000 km**

## pg. 61 Cooling system



### Changing coolant

Every two years or 30,000 miles (48,000 km) the cooling system should be drained, flushed and refilled. Remove the expansion tank cap. Open the drain cock on right side of the engine block and disconnect the lower radiator hose.

**Fill coolant through the expansion tank. The heater controls should be fully open when draining and filling.**

ADD coolant until the level is up to the MAX mark or slightly above.



Start engine and run until hot. Check the cooling system connections for tightness. Also re-check the coolant level. Capacity: 9.9 US qts. = 9.4 liters (manual transmission models); 9.7 US qts = 9.2 liters (automatic transmission models)

### Cooling system, hoses and connections

Check all cooling system hoses and connections for defects or deterioration of hoses and loose clamps or fittings.

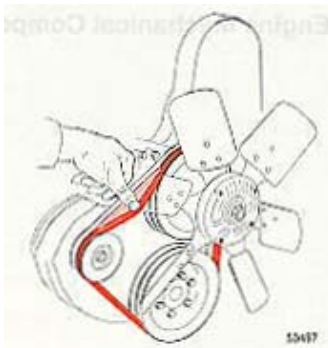

**Drive belts**

The belt tension can be checked by depressing the fan belt at a point midway between the alternator and fan pulleys as illustrated. It should be possible to press down the belt about 1/4" - 1/2" (5-10 mm). This also applies to other drive belts on the engine.

If drive belts are replaced, recheck belt tension after driving 600-1,200 miles (1,000-2,000 km).

pg. 62 Service requirements

**Engine Mechanical Components****Torque manifold nuts**

The manifold nuts should be torqued at the 600-1,200 mile (1,000-2,000 km) inspection. A loose manifold could alter air/fuel ratio and cause an increase in emission and/or poor driveability.

**Valves**

The valve clearance should be checked every 30,000 miles (50,000 km).

**Vacuum fittings, hoses and connections**

Unstable idle, misfiring or poor emission control is often caused by leaking vacuum hoses or connections. Check hoses and connections on distributor vacuum unit, EGR valve (where applicable) and connections on heater control servo systems and hydraulic brake servo.

**Exhaust Gas Recirculation (EGR)**

This system operates by returning some of the exhaust gases to the engine to be recombusted: since this lowers the combustion temperature the amount of nitrogen oxides released into the atmosphere is reduced.

The EGR valve should be inspected every 12,000 miles (20,000 km) and cleaned every 24,000 miles (40,000 km).

**Timing belt**

The timing belt tensioner should be adjusted at the 600-1,200 mile (1,000-2,000 km) inspection.

pg. 63 Servicing

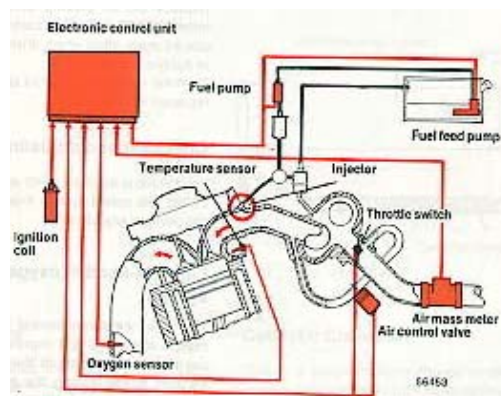
**Engine Fuel System****LH-Jetronic B230F engine**

The LH-Jetronic fuel injection system is all-electronic and is microprocessor controlled. It can continually compensate for variations in engine load, speed and temperature to give the best economy and power. The most unique feature of the system is the air mass meter which measures the mass of the inducted air instead of the volume. In this way the system can make instantaneous adjustments for changes in air temperature or density, thus always assuring the best economy with the lowest possible exhaust emissions.

pg. 64 Servicing

**Special instructions for work on the fuel injection system**

Extreme cleanliness is essential when working on the injection system. Great care must be observed.

Injection system service should be handled by qualified technicians, using equipment intended for this service.

**Fuel (line) filter**

We recommend that this filter be changed every 60,000 miles (96,000 km). The filter is replaced as one complete unit. Replace more frequently if contaminated fuel was introduced into the tank.

**Fuel system cap, tank, lines and connections**

The ability of the fuel system to control hydrocarbon emissions is dependent largely on a leak-free system. Check for proper sealing of gasoline filler cap which contains "O"-ring type seals. Check all evaporative hoses in vehicle for tightness. Check fuel lines under vehicle. Repair if necessary.

**Air cleaner**

Replace the air cleaner cartridge every 30,000 miles (48,000 km). The cartridge should be replaced more often when driving under dirty and/or dusty conditions. The filter cannot be cleaned and should always be replaced with a new one.

**Checking and adjusting idle speed**

Your Volvo is equipped with an electronically controlled idle speed system that requires no period checking or adjustment.

**Lambda-sond® (oxygen sensor) system**

This is an emission control system designed to reduce emissions and improve fuel economy. An oxygen sensor monitors the composition of the exhaust gases leaving the engine. The exhaust gas analysis is fed into an electronic unit which continuously influences the amount of fuel injected. This adjusts the air-fuel ratio to provide optimum conditions for combustion and efficient reduction of the three major pollutants (hydrocarbons, carbon monoxide and nitrogen oxides) through a 3-way catalytic converter.

pg. 65 Servicing

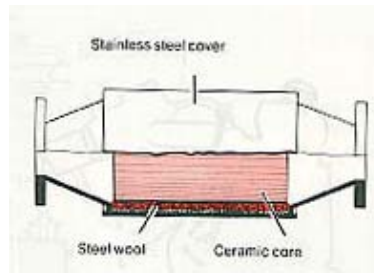
**Oxygen Sensor**

On the B230F engines, the oxygen sensor (Lambda-sond®) is electrically heated. The use of a PTC (Positive Temperature Coefficient) element to heat the Lambda-sond ensures a shorter warm up time and continuous operation at its working temperature.

**This type of Lambda-sond® does not require periodic replacement.**

**Catalytic Converter**

This is a supplementary device in the exhaust system, designed to reduce exhaust emissions. This device is mainly a container with a ceramic material insert, designed to let the exhaust gases pass through channels in the insert. The channel walls are covered by a thin layer of platinum and rhodium. These metals act as catalysts, permitting a chemical action to occur without actually taking part in it. The carbon monoxide content will increase if the Catalytic Converter is damaged.

**CAUTION:**

Vehicles with Catalytic Converter must use unleaded fuel only. Otherwise the Catalytic Converter will become damaged and ineffective.

**Torque catalytic converter mounting bolts**

The Catalytic Converter mounting bolts should be re-torqued at the 600-1,200 mile (1000-2000) km inspection.

pg. 66 Servicing

**Engine Crankcase Ventilation System**

## Crankcase ventilation

The engine is provided with positive crankcase ventilation (PCV) which prevents crankcase gases from being released into the atmosphere. Instead, the crankcase gases are admitted to the intake manifold and cylinders.

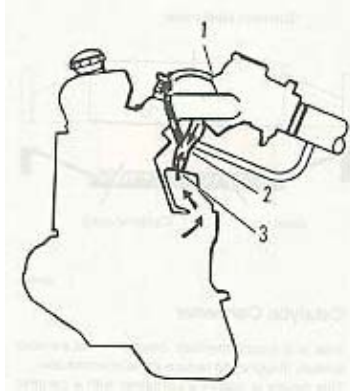

### B230F

1. PCV nipple
2. Flame Guard
3. Oil trap

### PCV system, B230F engine

The PCV nipple in the intake manifold should be cleaned after 60,000 miles (96,000 km).

pg. 67 Servicing

## Engine Evaporative Emissions

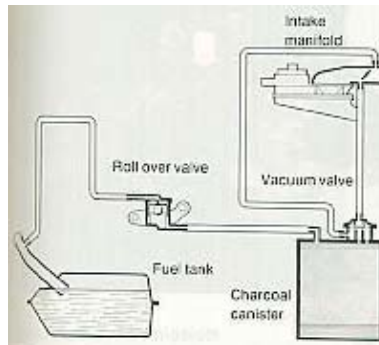

### Evaporative control systems

Vehicles intended for the North American market are equipped with a fuel vapor evaporative control system, which prevents gasoline fumes from being released into the atmosphere.

The system is comprised of an expansion chamber in the fuel tank, a roll-over valve on the cross member in front of the fuel tank, and a charcoal canister with built-in vacuum valve. The components are interconnected by hoses which channel fuel vapor from the gas tank to the charcoal filter where they are stored until the engine is started and then drawn into the engine fuel induction system.

## Engine Ignition

### Change spark plugs

The spark plugs should be changed every 30,000 miles (48,000 km).

However, prolonged city driving or fast highway driving may necessitate changing spark plugs after 10,000 miles (16,000 km) of driving. When installing new plugs, be sure to fit the right type and use the correct torque, see "Specifications". When changing the spark plugs, check that the suppressor connectors are in good condition. Cracked or damaged connectors should be replaced.

When changing spark plugs, clean the cables and cable terminals, also the rubber seals. If the car is driven on roads where salt is used during the winter, coat the cables with silicone.

**WARNING!**

The ignition system operates at very high voltages. Special safety precautions must be followed to prevent injury:  
Always turn the ignition off when:

- connecting engine test and diagnostic equipment to the vehicle (timing light, tach-dwell tester, ignition oscilloscope, etc.).
- Replacing ignition components e.g. plugs coil, distributor, high-tension leads etc.



[Contents](#) | [Top of Page](#)

---



# 1989 VOLVO 240

pg. 68 Manual transmission

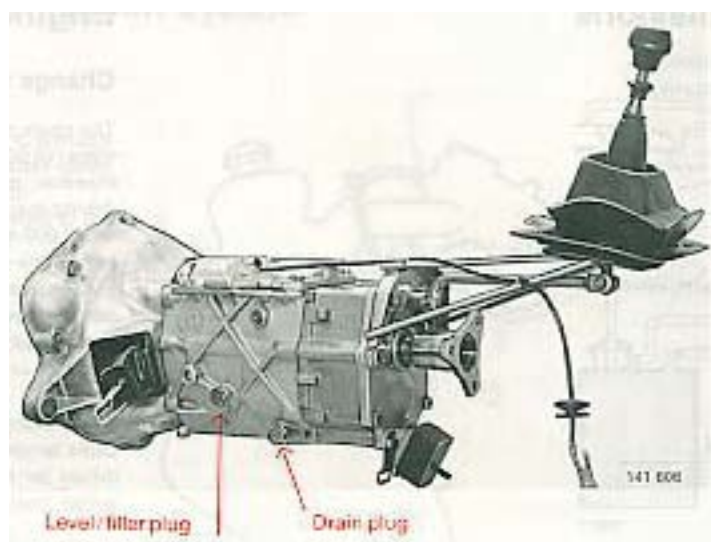

## Manual transmission with overdrive, M47 II

Capacity: 1.6 US qts = 1.5 liters.

Fluid type: Automatic Transmission Fluid Type F

Replace: at 600-1,200 mile (1,000-2,000 km) service only.

The oil level should be up to the level/filler plug.

When replacing transmission oil, drain the oil immediately after driving, while it is still hot, by removing the drain plug.

### **WARNING!**

Use care to prevent possible burning from hot transmission oil.

pg. 69 Automatic transmission

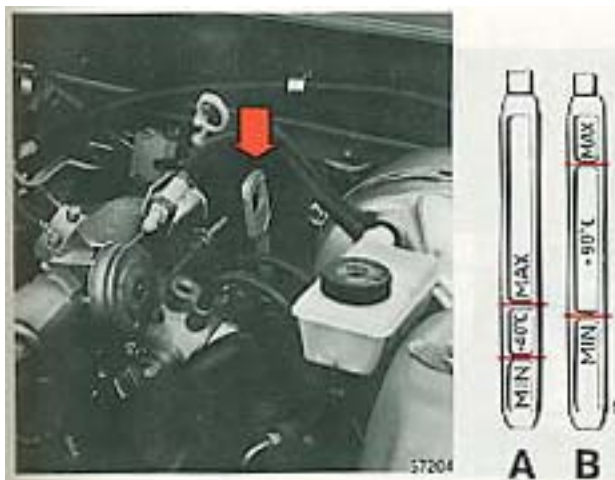

### Automatic transmission

Capacity: 7.8 US qts (7.4 liters)

Fluid type: Automatic Transmission Fluid type Dexron II D.

Replace: every 20,000 miles (32,000 km).

**A Cold transmission: oil temperature = +105° F (+40° C).**

This is a normal temperature for the transmission after idling for about 10 minutes. At oil temperature below +105° F(+40° C), the level may be below the MIN mark.

**B Warm transmission: oil temperature = +195° F(+90° C).**

This temperature is obtained when driving for about 30 minutes.

At oil temperature above +195° F(+90° C), the level may be above the MAX mark.

**Note!** The engine should be idling when checking transmission fluid level.

**Check the oil level as follows:**

**Park the car on level surface with the engine idling.**

Slowly move the selector lever through all the gear positions and then to position P. Wait 2 minutes before checking the oil level. As the illustration shows, the dipstick has a "Cold" and a "Warm" side. The oil level should be between the MIN and MAX marks. Wipe the dipstick with a clean cloth.

### **WARNING!**

The oil may be very hot!

Do not use rags which can leave lint on the dipstick.

The transmission is topped up via the dipstick tube.

The space between the MIN and MAX marks on the dipstick corresponds to 0.5 US qts (0.5 liter). Do

not fill the transmission with too much oil, since this can result in oil being ejected from the transmission. Too little oil, on the other hand, can negatively affect transmission operation, particularly in very cold weather.

pg. 70 Rear axle oil, Power steering fluid, Brake fluid



### Rear axle oil

Capacity: 1030 1.4 US qts - 1.3 liters

1031 1.7USqts - 1.6 liters.

Oil type: API GL-5 (MIL-L-2105 B or C) or Volvo Rear Axle Oil 1161329

Viscosity: SAE 90 or 80W/90

Replace: at 600-1,200 mile (1,000-2,000 km) service only.

The oil level should be up to the filler plug (A).

Drain rear axle oil through drain plug (B).

When the temperature is consistently below 15° F (-10° C), use API GL-5 SAE 80/90 W oil.

Cars equipped with limited slip differentials should use oils with proper additives.

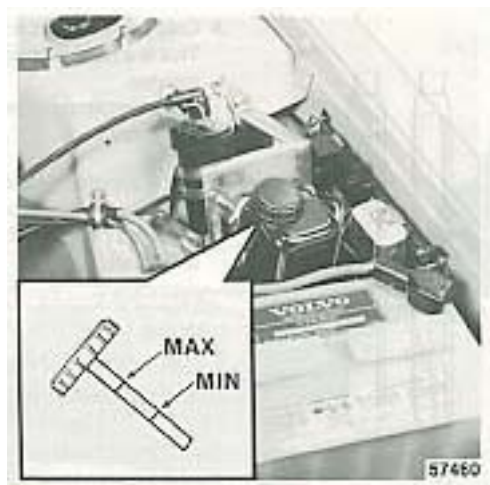

### Power steering fluid

Capacity: 0.8 US qts = 0.75 liters.

Fluid type: ATF

Replace: no fluid change required.

The dipstick is attached to the cap. Fluid level should be between MIN and MAX marks. Add fluid when the level is at the ADD mark



### Brake fluid

Fluid type: DOT 4

Replace: every 2 years or 30,000 miles (48,000 km).

Check, without removing the cap, that the level is above the "MIN" mark of the fluid reservoir. Always entrust brake fluid changing to a Volvo dealer.

Change brake fluid every year when driving under extremely hard conditions (mountain driving etc.) and if the car is equipped with a non-factory air dam.

pg. 71 Body lubrication



### Chassis maintenance

To simplify maintenance, your Volvo has been equipped with ball joints, steering rods and propeller shafts that do not require regular lubrication.

Points that normally require lubricating have been packed with very durable grease at the factory and then carefully sealed, eliminating the need for subsequent lubrication.

### Lubricate body

To avoid rattles and unnecessary wear, the body should be lubricated once a year. Hinges on hood, doors and trunk lid as well as door stops should be lubricated every 10,000 miles (16,000 km).

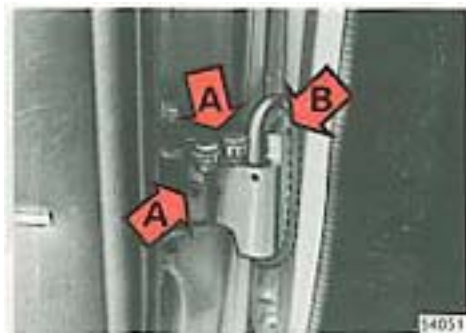

### NO. Lubricating point

- 1 Trunk lid lock keyhole
- 2 Trunk lid hinges
- 3 Door lock keyhole outer sliding surfaces
- 4 Sunroof wind deflector
- 5 Hood hinges
- 6 Hood lock
- 7 Front seat slide rails and latch devices
- 8 Window regulator
- Locking device (Accessible after door upholstery panels removed)
- 9 Door hinges
- Door stop

### Lubricant

- Low temperature grease
- Oil
- Paraffin wax
- Oil
- Oil
- Paraffin wax
- Oil
- Oil, grease
- Silicon grease
- Grease
- Oil



### Check coolant level

The cooling system must be filled with coolant and not leak to operate at maximum efficiency. Check the coolant level whenever you refuel. The level should be between the "Max" and "Min" marks on the expansion tank. The check should be made with particular thoroughness when the engine is new or the cooling system has been drained.

Do not remove the filler cap other than for topping-up with coolant. Frequent removal may prevent coolant circulation between the engine and the expansion tank during engine warm-up and cooling.

### CAUTION

The cooling system must always be kept filled to the correct level.

If it is not kept filled, there can be high local temperatures in the engine which could result in damage.

### Top up with coolant

Top up with coolant by filling the expansion tank when level is at the "Min" mark. Use a mixture of 50 percent Volvo Type C coolant and 50 percent water all the year round. Top up to the "Max" mark.

**If the engine is warm, and you are going to add coolant, unscrew the cap slowly in order to allow any excess pressure to escape.**

**Note:** Do not add water only. Water by itself reduces the rust-protective and anti-freezing qualities of the coolant and has a lower boiling point. It can also cause damage to the cooling system if it should freeze.

See "Specifications" section of the manual to type of coolant recommended.

### Cooling system

The risk of overheating is greatest, especially in hot weather, when:

- towing a trailer up steep inclines for prolonged periods at full throttle, and at low engine rpm.
- idling for prolonged periods while the air conditioning system is in operation.

- stopping the engine suddenly after high speed driving, so-called after-boiling.

To avoid overheating, the following rules should be followed.

- Reduce speed and downshift when towing a trailer up long steep inclines. The risk of overheating can be reduced by switching off the air conditioning system for a short while.
- Do not let the engine idle unnecessarily.
- Do not stop the engine immediately after highspeed driving, but allow the engine to idle for 1/2 - 1 minute before switching off.

When the risk of overheating is imminent, or in the event of overheating, (the temperature gauge goes repeatedly into, or stays continually in, the red section) the following precautions should be taken:

- Switch off the air conditioning system.
- Stop the car and put the gear lever into neutral position-position N. **Do not stop the engine!**
- Increase the engine speed to approx. 2000 rpm (twice idling speed).
- Check the level of coolant in the expansion tank. Top-up, if necessary.

pg. 73 Alternator, Jump starting

### Electrical System cautions

When changing the battery or when carrying out work involving the electrical system, the following should be observed:

- 1 A battery connection to the wrong terminal will damage the diodes. Before connections are made, check the polarity of the battery with a voltmeter.
- 2 If booster batteries are used for starting, they must be properly connected to prevent the diodes from being damaged. For correct connection, see "Jump starting".
- 3 The battery leads should be disconnected any time the battery is being charged.
- 4 Never disconnect the battery circuit (for example, to change the battery) while the engine is running, as this will immediately ruin the alternator. Always make sure that all the battery connections are cleaned and properly tightened.
- 5 if any electrical welding work is performed on the vehicle, the ground lead and all the connecting cables of the alternator must be disconnected and the welder wires placed as near the welding point as possible.

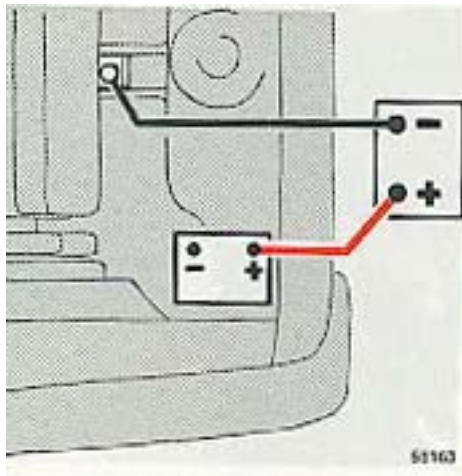

## Jump starting

---

**CAUTION:** Improper hook-up of jumper cables or the use of other than 12 volt batteries could result in damage to equipment and/or battery.

---

Check that cars are not touching to prevent premature completion of negative circuit. Note the position of the battery terminals. When using jumper cables, first connect booster battery positive (+) terminal to car battery positive (+) terminal. Then connect booster battery negative (-) terminal to a stationary solid metal part on the engine at a point away from the battery. Do not connect booster cable to any part of fuel system or any moving parts. Avoid touching hot manifolds.

### **WARNING!**

To prevent possible explosion, never expose battery to open flame or electric spark. Do not smoke near battery. Batteries generate hydrogen gas which is flammable and explosive.

Battery fluid contains sulfuric acid which can cause serious injury.

Do not allow battery acid to contact eyes, skin, fabrics or painted surfaces. If contact occurs, thoroughly flush affected area immediately with water. Obtain medical attention immediately if eyes are affected.

After engine has started first remove negative (-) jumper cable, then positive (+) terminal jumper cable.

pg. 74 Replacing bulbs

## Replacing bulbs



The replacement of bulbs in the various lighting units is shown on the following pages. Make sure when installing bulbs, that the guide pin on the socket fits into its corresponding recess.

When installing bulbs, do not touch the glass with your fingers. The reason for this is that grease, oil or any other impurities can be carbonized onto the bulb and damage the reflector.

Use bulbs of correct type and voltage. Failure to do so could activate the bulb failure warning light.

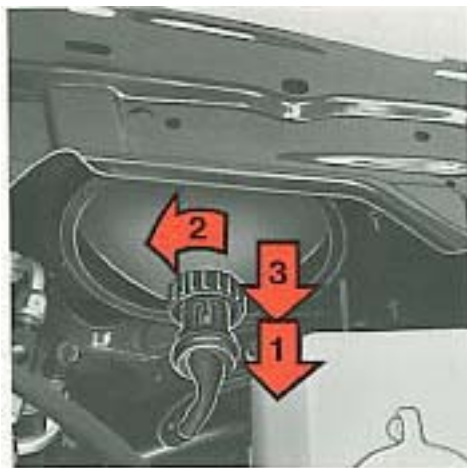

**Replacing headlight bulbs** Working inside the engine compartment, separate the socket contact from the bulb holder (1). Unscrew and remove the bulb holder retaining ring (2). Pull out the bulb holder assembly, and replace it as a unit (3).

Installation is the reverse of removal.

### Check headlight alignment.

Bulb	Power	Trade No.
Headlamp	45/65W	9004



### Front light bulbs

Loosen the Phillips screws and remove the lens The bulbs can now be removed by pressing them

inwards and turning them slightly counterclockwise. When reinstalling lens, check that the gasket is in position.

Bulbs	Power	Socket
1 Front position Side marker-lights	CP(W) 24/2.2 (21/5)	BaY 15d 1)
2 Front turn signal	24/2.2 (21/5)	BaY 15d 1)

1) US Bulb No.  
1157NA

## pg. 75 Replacing bulbs

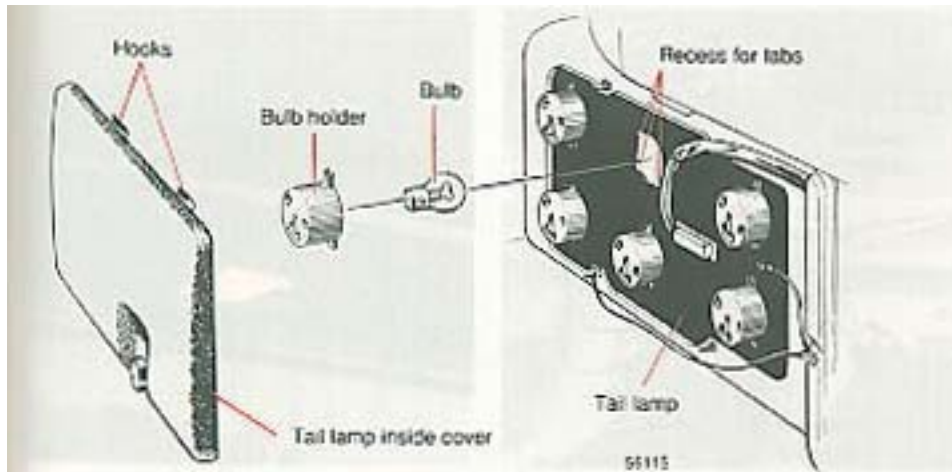

### Tail lamp bulbs, sedan model

All tail lamp bulbs are replaced from inside of trunk.

1 Unscrew and remove tail lamp inside cover. Note that inside cover is hooked at the upper edge. Lift the lower end out/up and unhook upper edge.

2 Turn bulb holder approx. 3/8" (1 cm) counterclockwise and remove it.

3 Depress bulb in bulb holder, turn it slightly counterclockwise, and remove it.

4 Install a new bulb. Install bulb holder in tail lamp. NOTE: One of the bulb holder tabs is wider and fits only in corresponding recess.

Turn bulb holder clockwise. Check that bulb lights. Replace tail lamp inside cover.



Bulbs	Power		Socket	US Bulb No
	CP	W		
1 Rear fog light*	32	21	Ba15s	1156
2 Back-up light	32	21	Ba15s	1156
3 Rear turn signal	32	21	Ba15s	1156
4 Tail light	4	5	Ba15s	67
5 Reflector	-	-	-	-
6 Brake light/tail light	32/3	21/5	BaY 15d	1157

"certain models only. On other models brake light is at location 1.  
Right side lamp holders are white. Left side lamp holders are black.

pg. 76 Replacing bulbs



### Tail lamp bulbs, wagon model

All bulbs in the tail light cluster are removed from the inside.

Changing bulb, left hand side:

- Remove the spare tire cover and the spare wheel.

### Changing bulb, right hand side:

- Remove the right hand stowage cover.
- Loosen the clip and move panel aside (see illustration). The procedure for changing a bulb is basically the same as for other models.

When re-installing, hold the bulb holder with the word "Volvo" turned towards the center of the car.

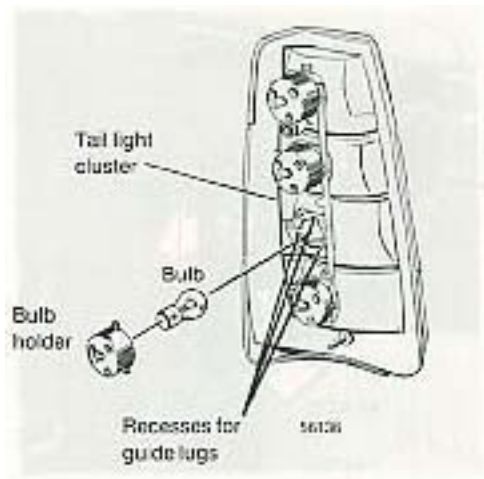

Bulbs	Power		Socket	US Bulb No
	CP	W		
1 Rear fog light*	32	21	Ba15s	1156
2 Back-up light	32	21	Ba15s	1156
3 Rear turn signal	32	21	Ba15s	1156
4 Brake light/tail light	32/3	21/5	BaY 15d	1157

\*certain models only. Other models have brake light at location 1.

Right side lamp holders are white

Left side lamp holders are black.



### License plate light, sedan model

Slide the bulb housing backwards until it is released from the front edge. Pull out the lamp housing and replace the bulb. Insert the front edge of the lamp housing and press up the rear edge by hand.

#### Bulbs

License plate light, sedan model

#### Power Socket

4W Ba 9s

pg. 77 Replacing bulbs



### License plate light, wagon model

Insert a screwdriver through the opening in the housing and depress the catch tab. Pull out the housing assembly.

#### Bulbs

License plate light, wagon

#### Power Socket

5W S 8.5-8

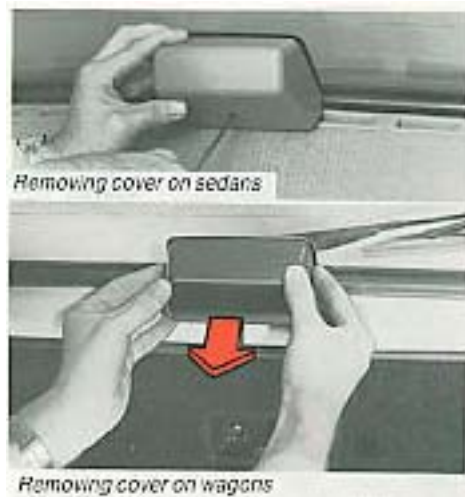

### High-mounted stop light

On sedans (top), use screwdriver to depress catch, then pull plastic cover up and away from the light assembly.

On wagons (bottom), remove plastic housing by pulling it up and away from the light assembly.

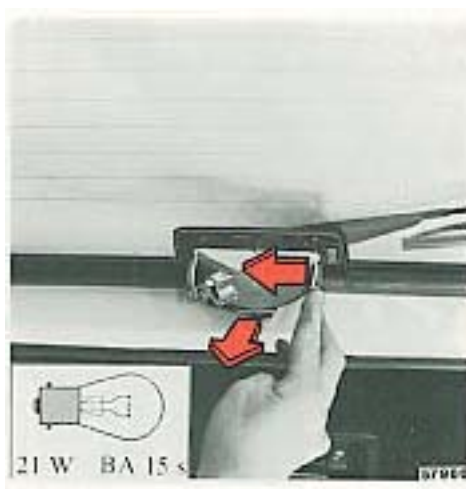

Press in reflector catch to release reflector assembly. Swing out reflector and replace bulb. Snap reflector in and check that bulb lights when brake pedal is depressed. Align cover and press into position.

Bulbs	Power Socket	US Bulb No
High-mounted	32cp/	
Stop light	21 W Ba15s	1156

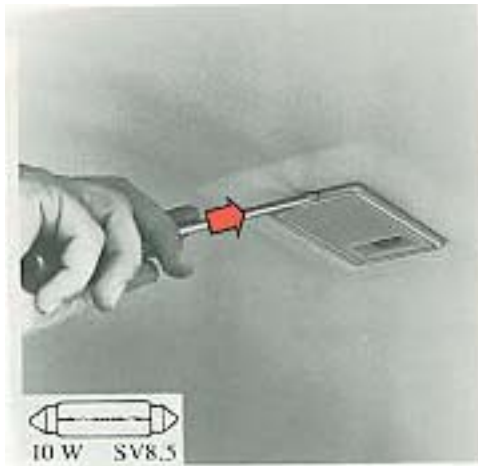

### Interior light

Insert a screwdriver through the opening in the right side of the housing and depress the catch tab. Pull out the housing assembly and replace the bulb.

Bulbs	Power Socket
Interior light	10W S 8.5-8

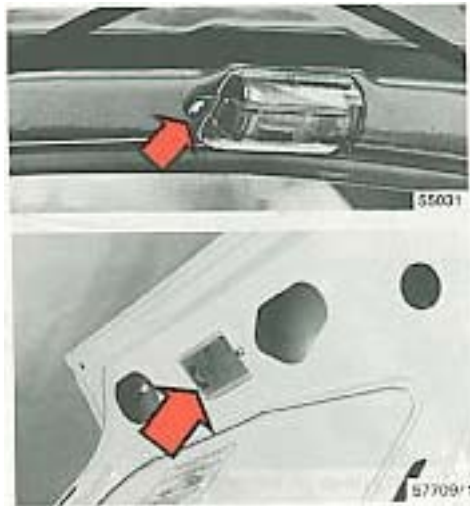

### Engine compartment light, Trunk light

Remove screw holding the light assembly. Lift it out to remove.

Replace the bulb.

Reinstall by first inserting the guides into one side, then press in the light assembly and install the screw.

Bulbs	Power Socket
Engine compartment light	15W S 8.5-8
Trunk light	15W S 8.5-8

## Instrument and heater control lighting

Due to the location of these bulbs, their replacement should be carried out by a Volvo dealer.

pg. 79 Fuses

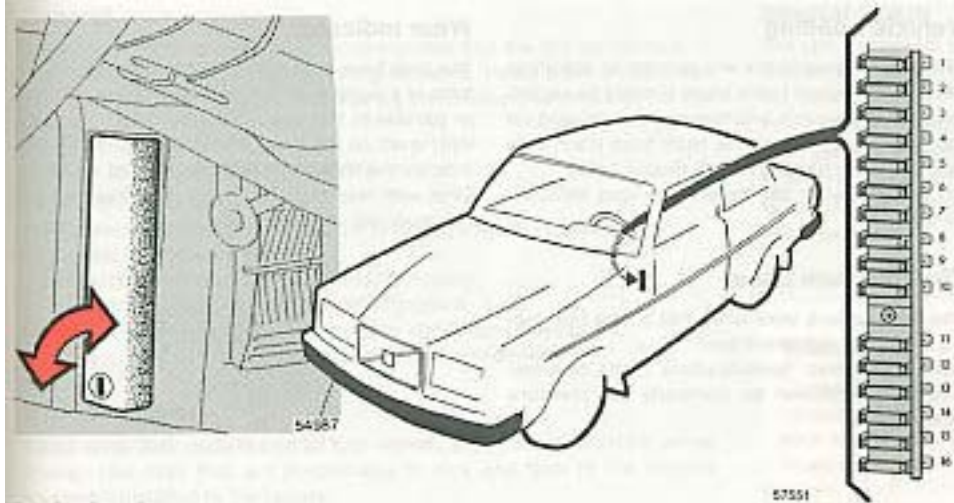

## Replacing fuses

The fuse box is positioned in front of the left front door pillar. When replacing fuses, check that the correct amperage is used.

**Never** use fuses of higher amperage, unless specified by your Volvo dealer. If one fuse repeatedly fails, take the car to your Volvo dealer for fault-tracing. A spare fuse kit is available from your Volvo dealer.

### **WARNING!**

Turn starting (ignition) switch OFF before replacing fuses. Excessive heat may be created by a short circuit. Care must be exercised while replacing blown fuses.

Some of the equipment listed below is optional

1 Cigarette lighter, El. operated side mirrors, Radio, Tailgate wiper/washer, Cruise control (governor)	8 A
2 Windshield wiper/washer, Horn	16A
3 Heater blower	25A
4 Fuel feed pump (tank)	8A
5 Spare	
6 Main fuel pump	16A
7 Brake lights, Cruise control (switch)	8A



8 Interior light, Glove box light, Trunk light, Engine compartment light, Central locking, El. radio antenna, clock	8A
9 Hazard warning flashers, shift indicator light	8A
10 Power windows	16A
11 4th gear (automatic transmission), heated rear window	16A
12 Back-up lights, Window lifts (relay), Air conditioning (with blower control), Rear window demist (switch)	8A
13 Turn signals, seat belt reminder lights, heated front seats, fuel injection system	8A
14 Rear fog lights	8A
15 Parking lights (left side), License plate light	8A
16 Parking lights (right side), Light on instruments and controls	8A
Blade type fuse, serving LH-Jetronic fuel injection system. Located on the left wheel housing by the ignition coil.	25A

Refer to the fuse location chart at fuse box for fuses specific to your car.

## pg. 80 Wheels and tires

### Checking and correcting tire pressure

Check the tire pressure when refueling. The tire pressure should only be corrected when the tires are cold. With warm tires, correct only when the pressure is too low. The tire temperature (and, thus, pressure) rises after driving just a few miles.

### **WARNING!**

Improperly inflated tires will reduce tire life, adversely affect vehicle handling and can possibly lead to failure resulting in loss of vehicle control without prior warning.

### Vehicle Loading

The tires on your Volvo will perform to specifications at all normal loads when inflated as recommended on the tire information label located on the rear facing side of the right front door. This label lists both tire and vehicle design limits.

Do not load your car beyond the load limits indicated.

### Tire Pressure Label

The tire pressure label is located on the rear facing side of the right front door. See section titled "Specifications" and Consumer Information Booklet for complete tire pressure information.

## Wear indicator

The tires have a so-called "wear indicator" in the form of a number of narrow strips running across or parallel to the tread. When approx. 1/16" (1.5 mm) is left on the tread, these strips show up and indicate the tire should be replaced.

Tires with less than 1/6" (1.5 mm) tread have a very poor grip in rain or snow.

pg. 81 Wheels and tires

## General

When replacing worn tires, it is recommended that the tire be identical in type (radial) and size as the one being replaced. Using a tire of the same make (manufacturer) will prevent altering the driving characteristics of the vehicle.

## How to improve tire economy

- Maintain correct tire pressure.
- Drive smoothly: avoid fast starts, hard braking and tire screeching.
- Tire wear increases with speed.
- Do not change wheel location unless necessary.
- Correct front wheel alignment is very important.
- Unbalanced wheels impair tire economy and driving comfort.
- Hitting curbs can damage the tires and/or wheels permanently.

## Winter Season

Radial snow tires, installed on all four wheels, are recommended for winter driving. Use tires that are comparable in size and type to the original equipment installed by the factory.

Mixing tires of different size, brand, or design could negatively affect tire road grip, especially when slippery road conditions exist.

**Note:** Overall diameter of tire and wheel combination will affect speedometer accuracy and fuel economy.

Tire **chains** can be used on the rear wheels if the chains do not project too far from the tire and chafe against the brake caliper or other components. **Strap-on emergency chains must not be used since the space between the brake caliper and the wheel rim is inadequate.**

## Special Spare

The spare wheel for your car is referred to as a "Special Spare". This name is embossed on the tire. On sedan models, the "Special Spare" tire has a 6-ply rating and, on the wagon models, an 8-ply rating tire.

Tire pressure must be 36 psi (250 kPa) on a 6-ply rating tire and 40 psi (280 kPa) on a 8-ply rating tire

irrespective of load or where the wheel is installed. In the event of a damage to this tire a new one can be purchased from your Volvo dealer.

**WARNING!**

Current legislation prohibits the use of this tire other than as a temporary replacement for a punctured tire. In other words, it must be replaced as soon as possible by a standard tire. Roadholding, etc., might be affected with the "Special Spare" in use. Do not exceed 50 mph (80 km/h).

**WARNING!**

**Special wheel rims**

Only special wheel rims, tested and approved by Volvo, are suitable for use with the factory-installed air dam. Any other wheel rims may not permit sufficient air circulation for brake cooling.

pg. 82 Wheel changing



**Changing a wheel**

Spare wheel, jack and tool kit are stowed in the trunk compartment. Make sure that the spare wheel is secured. Before raising the car with the jack be sure it is on firm and level ground.

**WARNING!**

Do not crawl or work under the car while it is raised by the jack.

Before the car is raised with the jack the parking brake should be applied and one of the gears engaged. With automatic transmission, the selector should be in **Park**. Block one of the wheels on the opposite side of the car from the jack.



**Note:** To avoid excessive tire wear and rebalancing, mark and reinstall wheels in same location and position as before removal. To lessen the chance of imbalance, each wheel hub is equipped with a guide stud to ensure that a removed wheel can be reinstalled in its original position.



## Removal

240 DL: Grasp the wheel cover with both hands and pull off.

240 GL: Pry the center emblem off with a screwdriver. The wheel cover can then be removed by hand. Loosen the wheel nuts 1/2-1 turn with the box wrench provided in the tool kit. All of the wheel nuts have right-hand threads which are loosened by turning them counterclockwise.

## Installation

Clean the contact surfaces on the wheel and hub. Lift the wheel and place it on the hub. Make sure that you align the wheel with the guide stud on the wheel hub prior to installation. Install the wheel nuts

clockwise and tighten lightly. The bevelled side of each nut should face the wheel. Lower the vehicle to the ground and alternately torque the nuts to 63 ft. lbs. (85 Nm). Install the wheel cap.

pg. 83 Wheel changing



### Using the jack

The spare wheel, jack and tool kit are stored in the trunk. On the wagon models the jack and crank should be secured according to the above illustration to avoid any disturbing rattle. Make sure that the spare wheel is secured.

Before using the jack make sure the car is standing on firm, level ground. Apply the parking brake and place the transmission in either first or reverse gear. If equipped with automatic transmission place the selector lever in position P. Block the wheels standing on the ground with wooden blocks or large stones. There is a jack attachment adjacent to each side wheel location. Hang the jack from the attachment as shown in the illustration and crank while simultaneously guiding the base to the ground. Before raising the car check that the jack is still correctly positioned in the attachment.



**WARNING!**

- The jack's hook must engage the pin in the jack attachment (A). The car's weight must not rest on the jack's hook (B).
- Never crawl under a car supported by a jack.
- Use the jack intended for the car when replacing a wheel. For any other job use stands to support the end of the car being worked on.
- Apply the parking brake, engage first or reverse gear (pos. P for cars equipped with automatic transmission).
- Block the wheels standing on the ground. Use rigid wooden blocks or large stones.
- The jack should stand on firm, level ground.
- The jack should be kept well-greased.
- Do not rotate a raised rear wheel if the car is equipped with a limited slip differential. This will also rotate the opposite wheel (on the ground) and the car may slide off the jack.

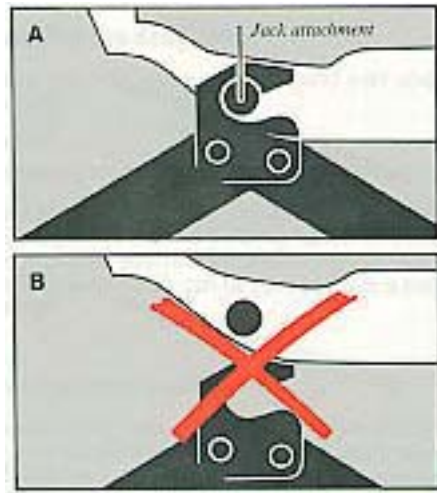

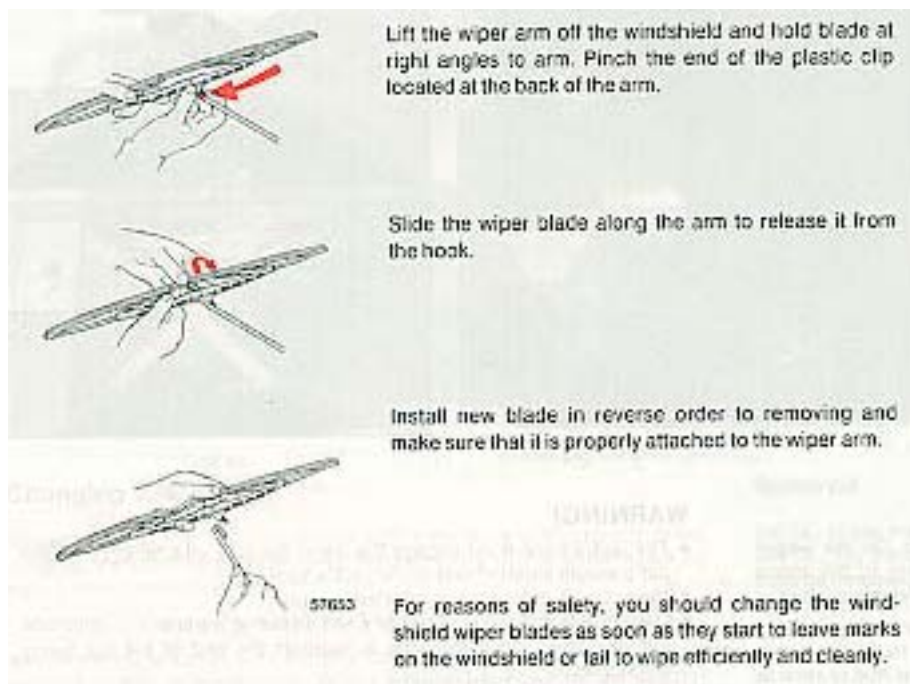

## Washing

The car should be washed at regular intervals since dirt, dust, insects and tar spots adhere to the paint and may cause damage.

When washing the car, do not expose it to direct sunlight. Use lukewarm water to soften the dirt before you wash with a sponge, and plenty of water, to avoid scratching.

A detergent can be used to facilitate the softening of dirt and oil. Special car washing detergent or household detergent can be used. A suitable mixture is about 2.5 fl. oz. (8.5 cl) of detergent to 2.6 US gal. = 10 liters of warm water. After washing with a detergent the car should be well rinsed with clean water.

A water soluble grease solvent may be used in cases of sticky dirt. However, use a washplace equipped with a drainage separator.

Dry the car with a clean chamois and remember to clean the drain holes in the doors and rocker panels

Tar spots can be removed with kerosene or tar remover after the car has been washed.

Electrically operated antenna (optional) should be dried and lightly lubricated with an oil dampened cloth.

---

**CAUTION:** It is particularly important to wash the car frequently in the winter time, to prevent corrosion, when salt has been used on the roads. Also wash off the dirt on the underside (Wheel housings and fenders etc).

## WARNING!

When the car is driven immediately after being washed, apply the brakes now and again in order to remove any moisture from the brake linings.



[Contents](#) | [Top of Page](#)

---



# 1 9 8 9 VOLVO 240

## pg. 85 Washing, Cleaning, Anti-rust treatment

### **Automatic washing - simple and quick**

An automatic wash is a simple and quick way to clean your car, but it is worth remembering that it can never be as thorough as when you yourself go over the car with sponge and water. Keeping the underbody clean is most important, especially in the winter. Some automatic washers do not have facilities for washing the underbody.

Before driving into an automatic wash, make sure that side view mirrors, auxiliary lamps, etc., are secure, otherwise there is risk of the machine dislodging them. You should also lower the antenna. We recommend that you do not wash your car in an automatic wash during the first six months (because the paint will not have hardened sufficiently).

### **Bird droppings**

Remove from paintwork as soon as possible. Otherwise the finish may be permanently damaged.

### **Chromed parts**

Chromium-plated and anodized parts should be washed with clean water as soon as they become dirty. This is particularly important if you drive on gravel roads or on roads where salt is used during the winter. After the car has been washed, apply wax or an anti-rust preparation. Stains on chrome trim can be removed with commercially available chrome cleaner. Do not use Abrasive compounds or steel wool.

### **Polishing (waxing)**

Normally, polishing is not required during the first year after delivery. Waxing may be beneficial. Before applying polish or wax the car must be washed and dried. Tar spots can be removed with kerosene or tar remover. Difficult spots may require a fine rubbing compound. After polishing use liquid or paste wax. Several commercially available products contain both polish and wax. Waxing alone does not substitute for polishing of a dull surface. A wide range of polymer based car waxes can be purchased today. The waxes are easy to use and produce a long lasting high gloss finish which protects the bodywork against oxidation, road dirt and fading.

### **Cleaning the upholstery**

Generally the **fabric** can be cleaned with soapy water or a detergent. For more difficult spots caused by

oil, ice cream, shoe polish, grease, etc., use a stain remover.

The **plastic** in the upholstery can be washed. To clean **leather upholstery**, use soft cloth and mild soap solution, for instance common bath soap.

For more difficult spots, consult an expert for the choice of cleaning agent.

**On no account must gasoline, naphtha or similar cleaning agents be used on the plastic or the leather since these can cause damage.**

**When aging, leather changes appearance, but the typical texture remains. To preserve smoothness and appearance, it is recommended to treat the leather with a special leather preservative after one or two years of use.**

### **Cleaning the seat belts**

Clean only with luke warm water and mild soap solution.

### **Cleaning floor mats**

The floor mats should be vacuumed or brushed clean regularly, especially during the winter when they should be taken out for drying.

Spots on textile mats can be removed with a mild detergent.

### **Anti-rust treatment**

Your Volvo has been rust protected at the factory. On external surfaces a heavy coat of wear resistant material has been used, while on the internal surfaces a lighter rust inhibitor is used.

The rust protection should be inspected regularly by your authorized Volvo dealer. Consult the Volvo Protection Limited Warranty found in your Warranty Information Booklet for additional terms and conditions.

For further information, see section titled "What causes rust" or see your Volvo dealer.

pg. 86 Paint touch-up

### **Paint touch-up**

Paint damage requires immediate attention to avoid rusting. Make it a habit to check the finish regularly, for instance when washing the car. Touch-up if necessary.

Paint repairs require special equipment and skill. Contact your Volvo dealer for any extensive damages. Minor scratches can be repaired by using Volvo touch-up paint.

**Note:** When ordering touch-up paint from your Volvo dealer, use the paint code indicated on the service label. The label is located on the wheel housing in the engine compartment.

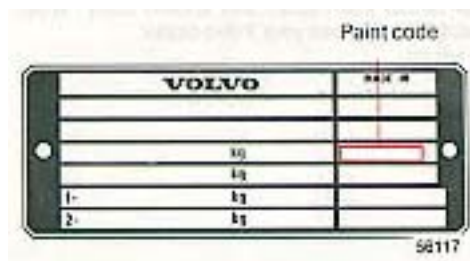

## Minor stone chips and scratches

Material:

Primer-can

Paint - can or touch-up bottle

Brush

Masking tape

**Note:** When touching-up the car, it should be clean and dry. The surface temperature should be above 60° F(+15° C).

## Scars on the surface

If the stone chip has not penetrated down to the metal and an undamaged layer of paint remains, the touch-up paint can be applied as soon as the spot has been cleaned.

## Deep scars

If the stone chip has penetrated down to the metal, proceed as follows:

1 Place a strip of masking tape over the damaged surface. Pull the tape off so that any loose flakes of paint adhere to it.

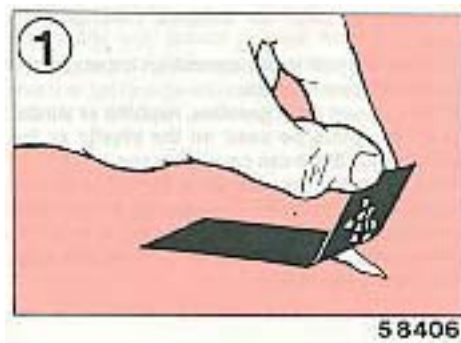

2 Thoroughly mix the primer and apply it with small brush.

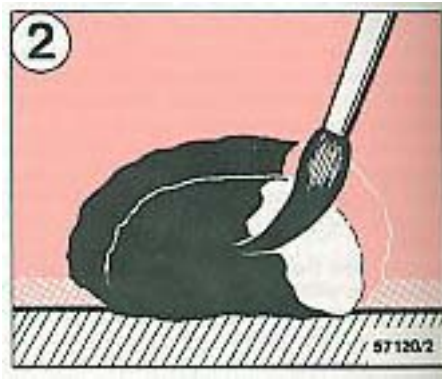

When the primer surface is dry, the paint can be applied using a brush. Mix the paint thoroughly, apply several thin paint coats and let dry after each application.

pg. 87 Paint touch-up

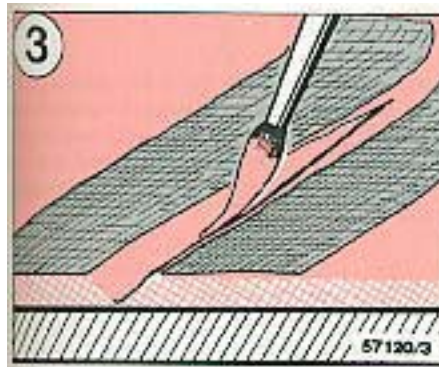

3 if there is a longer scratch, you may want to mask to protect surrounding paint.

### **Touching-up damaged paint on fender edges and sills**

Material:

Primer-spray can

Paint-spray can

Masking tape

**Note:** When touching-up the car, it should be clean and dry. The surface temperature should be above 60° F (+15° C).

When large surfaces have to be repainted, suitably mask the surrounding area with masking tape and paper. Remove this masking as soon as the final coat has been sprayed on, before the paint dries.

1 Remove loose flakes of paint with masking tape. Shake the spray can for at least 1 minute. Spray the primer on.

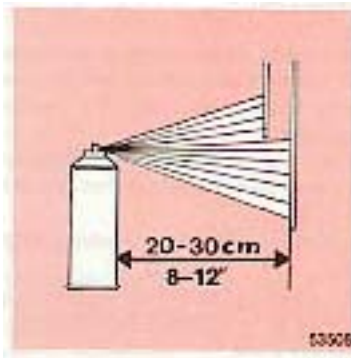

2 Move the spray can slowly and regularly from side to side, about 8-12 inches (20-30 cm) from the surface.

### **WARNING!**

Spray painting should be done in a well ventilated and dust-free area.

3 When the primer has dried, apply the surface enamel in the same way. Spray on several times and allow the paint to dry a minute or so between each application.

pg. 88 What causes rust

### **What causes rust**

#### **The two most common causes of rust to your car are:**

1. The accumulation of road dirt and moisture in hard-to-get-at cavities and other areas under the car.
2. The removal of paint and protective coatings on the outside of the car and underneath through damage by stones, gravel or minor accidents.

#### **Several factors influence the speed at which corrosion will occur:**

1. The length of time various parts of a car stay wet. Parts of the car filled with road dirt and water remain damp for long periods of time even after other parts have dried. Particular attention should be paid to the underside of the car and floor sections inside. The floor sections stay wet because moisture collects and remains under the floor matting. Drain holes located at the bottom of the doors can get clogged with dirt, trapping water inside the door and causing the door to rust through at the bottom.
2. Corrosion will be accelerated in areas of higher relative humidity, especially where temperatures often stay above the freezing point and where the atmosphere is affected by industrial pollution, or where salt is used for de-icing the roads. Where parts of the car are covered with road dirt containing road salt, corrosion will be accelerated at a lower relative humidity than if the surface were clean.
3. Increased temperature will cause an accelerated rate of corrosion of those parts of the car which are

not well ventilated to permit quick drying.

4. Industrial pollution and the presence of salt will also accelerate the deterioration of paint finishes.

The foregoing underscores the need for every car owner to keep his or her car, particularly the underside, as clean and dry as possible. Repair any minor damage to paint work and protective coating as soon as possible. The need is more important in those localities where road salt is used for de-icing, the relative humidity is higher, air pollution is present and temperatures regularly stay above freezing.

pg. 89 Long distance trips, Cold weather

### **Prior to a long distance trip**

Have your car checked at a Volvo dealer. Preventive maintenance will help to ensure a trouble free trip.

Remember to take along a Volvo dealer directory.

The main items to check are listed below:

1. Brakes, front wheel alignment and steering gear.
2. Engine running condition.
3. Fuel system operation.
4. Oil leaks: engine, transmission, rear axle.
5. Cooling system for leaks or worn hoses.
6. Examine tires carefully, replace worn tires.
7. Battery and terminals.
8. Tool equipment.
9. Lighting.
10. Drive belts, for tightness and wear.
11. All fluid levels.

### **Cold weather Engine fuel system**

During the winter, large variations in temperature cause condensation to form in the fuel tank and can impair the running of the engine. This can be reduced by adding dry gas to the fuel. There is less risk of condensation forming in the fuel tank if it is kept full or nearly full.

### **Engine cooling system**

Volvo type C (blue-green) coolant should be used all the year round. The cooling system should always contain water plus anti-freeze and rust inhibitor, even during the summer. Experience has also shown that extremely weak anti-freeze solutions (10-25 percent) are ineffective for rust protection. For this reason, the quantity of anti-freeze/summer coolant should amount to about 50 percent of the solution. This lowers the freezing point to -30° F (-35° C).

### **Engine lubricating system**

During the winter, multigrade oil 10W-30 should be used in the engine.

The viscosity of the engine oil is important. Oil with low viscosity (thinner oil) improves cold-weather

starting as well as decreasing fuel consumption while the engine is warming up. For winter use, 5W-30 oil, particularly the synthetic type, is recommended.

Be sure to use good quality oil but do not use this cold-weather oil for hard driving or in warm weather. See section "Engine oil" for more information.

### Electrical system

The electrical system is subject to great stresses during the winter. Lighting and starter motor are used more often. The battery capacity is impaired at low air temperature. The state of charge must be checked more frequently, and if necessary the battery should be recharged. The battery may freeze if the state of charge is low.

### Windshield washers

Anti-freeze washer fluid should also be added to the washer fluid container for the windshield and rear window (tailgate, wagon model) washer. This is particularly important during the winter because the windshield frequently becomes dirty and is often splashed with water which freezes rapidly. This may necessitate the frequent use of the windshield washer and wipers. Your Volvo dealer can supply you with suitable anti-freeze for this purpose. Suitable mixtures of anti-freeze and water are:

Down to +14° F (-10° C) 1 part anti-freeze 4 parts water.

Down to + 7° F(-14° C) 1 part anti-freeze 3 parts water.

Down to 0° F(-18° C) 1 part anti-freeze 2 parts water.

Down to -18° F(-28° C) 1 part anti-freeze 1 part water.

Use Volvo Teflon lock spray or grease in the locks They can be purchased from your Volvo dealer.

**Note:** Avoid the use of de-icing sprays as they can cause damage to the locks.

pg. 90 Service diagnosis

The diagnoses outlined below are intended to serve only as a guide to locate and temporarily correct minor faults. Causes of unsatisfactory performance should be investigated and corrected by your Volvo dealer.

### Condition: Starter fails to operate (or operates very slowly)

Possible cause	Correction

Weak battery or dead cell.	With the starting (ignition) switch in the "Driving" or "On" position, check to see if the warning lights on the dashboard come on and if they stay on when the starter is engaged. If the lights do not come on or if they go off when the starter is engaged, the battery is discharged or see below.
Loose or corroded battery cable terminals.	Check battery terminals and clamps. Clean or replace if necessary. Check that the starter cable is secure at its terminals. The ground strap, which connects the battery negative (-) terminal to the engine, should also be checked for corrosion or looseness.
Open circuit between starting (ignition) switch and starting (ignition) switch terminal on starter.	The circuit is closed if a clicking sound is heard from the starter when it is engaged. If no clicking sound is heard, check that the blue wire at the starter is secure. If still no clicking sound is heard, the starting (ignition) switch or the wire is defective.
Starter motor defective.	If the above checks have been performed, and no fault is evident, the starter may be defective. NOTE: In this case the headlight intensity will not dim when the starter is engaged.

pg. 91 Service diagnosis

### Condition: Starter motor operates but engine does not start

Possible cause	Correction
Intake system leaking.	Check vacuum hose connections at manifold and auxiliary air valve.
No fuel reaching engine.	Check for fuel in the tank. Check fuses No 4,6 and 13
No spark	Check that the high tension lead from the coil to the distributor cap is connected and that the wires to the distributor and coil are connected. Check the fuse for the engine control system. The fuse is located in the engine compartment on the left wheel housing by the ignition coil.



Spark plugs, high tension leads or distributor cap wet or defective.

Clean the parts with a dry cloth or spray with a moisture remover. Replace defective or worn parts.  
If no fault is found following the above steps, contact your Volvo dealer.

pg. 92 Service diagnosis

### Condition: Erratic idle (misfiring)

Possible cause	Correction
intake system leaking.	Check hose connections.
Spark plugs, high tension leads or distributor cap worn (detective)	Clean distributor cap and leads, check the cap for cracks. Replace defective or worn parts.
Worn spark plugs.	Remove. Clean or replace spark plugs.

### Condition: Engine stalls at irregular intervals

Possible cause	Correction
Defective wires.	Check wire terminals at: fuel pump, fuse No. 5 and 7, coil, distributor, ignition switch and relays.
Intake system leaking.	Check vacuum hose connections at manifold and auxiliary air valve.
Fuel filter clogged.	Clean fuel tank filter and replace line fuel filter.

pg. 93 Service diagnosis

### Condition: Excessive fuel consumption

Possible cause	Correction
Fuel lines leaking.	Check tightness.
Spark plugs worn	Replace plugs.

### Condition: Misfiring at highway driving speed

Possible cause	Correction
Spark plugs fouled.	Drive the vehicle in a lower gear and keep the engine rpm higher for a few miles in order to remove carbon deposit on the spark plugs. If this procedure is not effective, clean or replace the spark plug.

## pg. 94 Label information

The Vehicle Identification Number should always be quoted in all correspondence concerning your vehicle with the dealer and when ordering parts.

### **1 Vehicle Identification Number (VIN)**

VIN plate is located on top left surface of dash. The VIN is also stamped on the right hand door pillar

### **2 Vehicle Emission Control Information**

Your Volvo is designed to meet all applicable safety and emissions standards. Evidence of this can be verified from the certification label on the left wheel valance. For further information regarding these regulations, please consult your Volvo dealer.

### **3 Model Plate**

Vehicle Identification Number (VIN). Codes for color and upholstery etc. This plate is located on right wheel valance.

### **4 Loads, Capacities, and Tire Pressures**

### **5 Federal Motor Vehicle Safety Standards (FMVSS) specifications (USA) and Ministry of Transport (CMVSS) Standards (Canada)**

This label is located on rear facing side of the driver's front door.

### **6 Service Label**

Label under rear window under trunk lid on right hand side (Sedan) or on right hand side of the large storage space (Wagon).

Information on certain components.

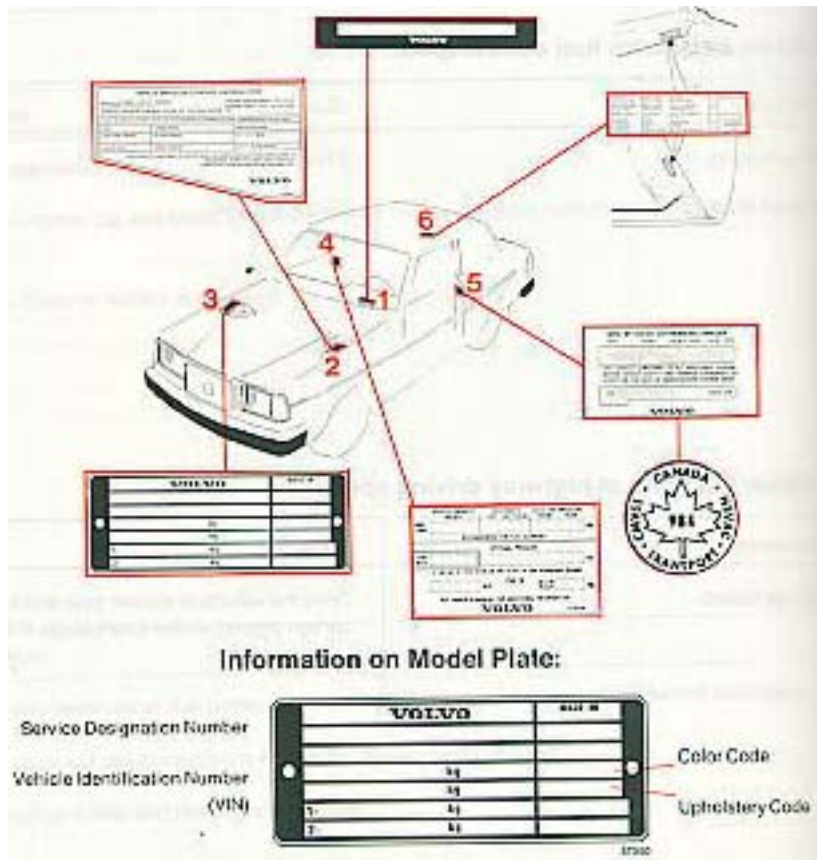

[Contents](#) | [Top of Page](#)

# 1989 VOLVO 240

## Specifications

### pg. 95 Specifications

Dimensions and weights 96

Cargo space 96

Engine 97

Cooling system 98

Fuel system 98

Ignition system 98

Power transmission 99

Front end 99

Capacities 100

Electrical system 100

### pg. 96 Specifications

#### **Dimensions and weights**

	Sedan Models	Wagon models
Length	189.9" (482 cm)	190.7" (484 cm)
Width	67.3" (171 cm)	67.3" (171 cm)
Height, curb weight	56.3" (143 cm)	57.5" (146 cm)
Wheelbase	104.3 " (265 cm)	104.3 " (265 cm)

Ground clearance (full load)	4.7" (12 cm)	4.7" (12 cm)
Track, front	56.3" (143 cm)	56.3" (143 cm)
Track, rear	53.5" (136 cm)	53.5" (136 cm)
Turning circle (between curbs)	32.2' (9.8 cm)	32.2' (9.8 cm)
Curb weight (depending on type)	2919-2985 lbs (1324-1354 kg)	3051-3097 lbs (1384-1405 kg)
Gross vehicle weight (GVW)	4030 lbs (1830 kg)	4300 lbs (1950 kg)
Capacity weight	960 lbs (435 kg)	1220 lbs (555 kg)
Permissible axle weight, front	1885 lbs (855 kg)	1885 lbs (855 kg)
Permissible axle weight, rear	2180 lbs (990 kg)	2600 lbs (1180 kg)
Max. trailer weight (trailer equipped with service brakes)	3300 lbs (1500 kg)	3300 lbs (1500 kg)
Max. hitch load	200 lbs. (90 kg)	200 lbs. (90 kg)

**Cargo Space****Wagon models**

Length with rear seat up	44.5" (113 cm)
Length with rear seat down	74.0" (188 cm)
Maximum width	53.1" (135 cm)
Height	32.9" (84 cm)
Volume with rear seat up	41 cu. ft. (1.2 m <sup>3</sup> )
Volume with rear seat down	76 cu. ft. (2.151 m <sup>3</sup> )
Cargo opening, maximum width	45.7" (116 cm)
Cargo opening, maximum height	30.7" (78 cm)

**Dimensions and weighs for Canadian models**

	4 door	Wagon
Length	482 cm	484 cm
Curb weight (depending on type)	1303-1314 kg	1367-1382 kg
Gross vehicle weight	1830 kg	1950 kg
Capacity weight	425 kg	495 kg
Permissible axle weight, rear	990kg	1120 kg

**WARNING!**

When adding accessories, equipment, luggage and other cargo to your vehicle, the total loaded weight capacity of the vehicle must not be exceeded. Consult your dealer for information.

pg. 97 Specifications

**Engine B230F (2.3 liters; 141 cu. in.)**

Liquid-cooled, gasoline, 4-cylinder in-line engine. Cast-iron cylinder block with cylinders bored directly in block. Aluminum-alloy cylinder head with single overhead camshaft and separate intake and outlet channels. Engine lubrication is provided by a gear pump driven from the crankshaft. Full-flow type oil filter. Exhaust-emission control accomplished by fuel injection, Lambda-sond® system and catalytic converter.

Output (SAE J1349)	114 hp at 5400 rpm (85 kW at 90 rps)	
Max. torque (SAE J1349)	136 ft. Ibs. (185 Nm) at 2750 rpm	
Number of cylinders	4	
Bore	3.78" (96 mm)	
Stroke	3.15" (80 mm)	
Displacement	2.32 liters (141 cu.in.)	
Compression ratio	9.8:1	
Valve clearance, cold engine inlet and exhaust	Checking:	Adjusting:
	0.012-0.016"	0.014-0.016"
	(0.30-0.40 mm)	(0.35-0.40 mm)
Valve clearance, warm engine inlet and exhaust		
	0.016-0.018"	0.014-0.016"
	(0.40-0.45 mm)	(0.35-0.40 mm)

All specifications are subject to change without notice.

pg. 98 Specifications

**Engine B230F  
Cooling System**

Type	Positive pressure, closed system
Thermostat begins to open at	188.6°F(87°C)
- fully open at	215°F(97°C)
Fan belts, designation	HC-38 X 918 (two)
Coolant: Volvo Coolant type C (blue-green)	

## Fuel system

The engine is equipped with the LH-Jetronic electronic fuel injection system.

## Ignition System

Firing order	1-3-4-2
Ignition setting	(12°B.T.D.C.at 750rpm)
Spark plugs	Bosch WR7DC (or equivalent)
Spark plug gap	0.028-0.032" (0.7-0.8 mm)
Tightening torque	15-22 ft. lbs. (20-30 Nm)
Distributor, direction of rotation	Clockwise

pg. 99 Specifications

## POWER TRANSMISSION

Manual or automatic transmission.  
Hypoid type final drive.

### Manual transmission M47 II

Reduction ratios:

1st gear 4.03:1

2nd gear 2.16:1

3rd gear 1.37:1

4th gear 1.00:1

5th gear 0.82:1

Reverse 3.68:1

Rear axle reduction ratio: 3.31:1

### Automatic transmission AW70

Reduction ratios:

1st gear 2.45:1  
 2nd gear 1.45:1  
 3rd gear 1:1  
 Overdrive 0.69:1  
 Reverse 2.22:1  
 Rear axle reduction ratio: 3.73:1

### Vehicle speed/1000 engine rpm (manual transmission)

Rear axle ratio 3.31:1

	mph	km/ h
--	-----	----------

1 st gear	5.4	8.7
2nd gear	10.0	16.2
3rd gear	15.8	25.5
4th gear	21.7	34.9
5th gear	26.4	42.5
Reverse	5.9	9.5

### Front End

McPherson type spring and strut suspension. Shock absorbers housed in strut casing. Rack and pinion steering.

Safety-type steering column.

The alignment specifications apply to an unloaded car but include fuel, coolant and spare wheel.

Toe-in, measured on the wheel rim:  $1/16" \pm 3/64"$  ( $1.5 \pm 1.0$  mm)

Camber (not to exceed  $1/2^\circ$  difference between sides):

-All.....  $+1/4^\circ$  to  $+3/4^\circ$

(Reduce camber if excessive wear on tire outer shoulder is observed)

Caster: not adjustable

pg. 100 Specifications

### Capacities

Fuel tank	15.8 US gals	60 liters
Cooling system		
-manual transmission	9.9 US qts	9.4 liters
-automatic transmission	9.7 US qts	9.2 liters



-expansion tank  
separately 0.7 US qts 0.6 liters

Engine:

-oil and filter change 4.0 US qts 3.85  
liters

-oil changed separately 3.5 US qts 3.35  
liters

Transmission:

-manual, M47 II 1.6 US qts 1.5 liters

-automatic, AW70 7.8 US qts 7.4 liters

Rear axle - 1030 1.4 US qts 1.3 liters

- 1031 1.7 US qts 1.6 liters

Power steering gear 0.8 US qts 0.75  
liters

Windshield washer fluid 3.4 US qts 3.2 liters

## ELECTRICAL SYSTEM

12 V, negative ground. Voltage-controlled alternator. Single-wire system with chassis and engine used as conductors.

Voltage 12 V

Battery: 450 A/90  
-capacity min

Alternator :

- rated 1120W, 80A  
output

Lights, 12 V	US bulb No.	Power	Socket	No. of bulbs
Headlights	9004	45 W/65 W		2
Position Lights, front	1157NA	21 W/24 cp	BaY 15d	2
		5 W/2.2 cp		2
Turn Signals, front	1157NA	21 W/24 cp	BaY 15d	2
		5 W/2.2 cp		

Turn Signals, rear	1156	21 W/32 cp	Ba 15s	2
Brake light/tail light	1157	21 W/31 cp	BaY 15d	2
		5 W/3 cp		
High-mounted brake light	1156	21 W/32 cp	Ba 15s	1
Back-up Lights	1156	21 W/32 cp	Ba 15s	2
Rear fog lights	1156	21 W/32 cp	Ba 15s	2

The following bulbs may be obtained from your nearest Volvo dealer.

Rear ash tray lights	1.2 W	W2x4.6d	1
License plate Light, Sedan	4 W	Ba9s	2
License plate Light, Wagon	5 W	S8.5-8	2
Interior Light	10 W	S8.5-8	1
Glovebox Light	2 W	Ba9s	1
Instrument Panel Light	3 W	W2.1x9.5d	2
Control Panel Light	1.2 W	W2x4.6d	3
Shift position, Auto Transmission	1.2 W	W2x4.6d	1
Engine Compartment Light	15 W	S8.5-8	1
Trunk Light	15 W	S8.5-8	1
Warning Indicator Lamps			
Charging	1.2 W	W2x4.6d	1
Turn Signals	1.2 W	W2x4.6d	2
Brake Failure	1.2 W	W2x4.6d	1
Parking Brake	1.2 W	W2x4.6d	1
Headlights	1.2 W	W2x4.6d	1
Oil Pressure	1.2 W	W2x4.6d	1
Overdrive Off(automatic trans)	1.2 W	W2x4.6d	1
Warning Flashers	1.2 W	W2x4.6d	1
El. Heated Window	1.2 W	W2x4.6d	1
Seat Belts	2 W	Ba9s	2

Bulb Failure	1.2 W	W2x4.6d	1
--------------	-------	---------	---

pg. 101 Specifications

## Recommended max. and min. speeds\*, mph (km/h)

### Manual transmission M47 II

1st gear	2nd gear	3rd gear	4th gear	5th gear
-25(-40)	10-44(20-70)	20-70(30-110)	25- (44-)	44-(70-)

\* always observe posted speed limits.

## Tool bag

Wheel nut wrench.

2 screwdrivers (1 Phillips, 1 standard)

Tommy bar.

2 open end wrenches.

## Vehicle Loading

The tires on your Volvo will perform to specifications at all normal loads when inflated as recommended on the tire information label located on the rear facing side of the right front door. This label lists both tire and vehicle design limits. Do not load your car beyond the load limits indicated. See Consumer Information Booklet for complete tire pressure information.

## Sample Tire Pressure Label



A

B

C

D

E

F

Model	Vehicle capacity weight	Recommended tire pressure (for fuel economy)				Tire Size	Optimal Tire Pressure 1-3 occupants				Special Spare	Special Spare tire pressure	
		front		rear			front		rear			Front/rear	
		psi	kPa	psi	kPa		psi	kPa	psi	kPa		psi	kPa
Sedan, USA	970 lbs	36	250	36	250	185/70T14	26	180	27	190	165-14	36	250
Sedan, Canada	425 kg	35	245	35	245	185/70T14	26	180	27	190	165-14	36	250
Wagon, USA	1220 lbs	36	250	36	250	185R 14 S	27	190	30	210	175-14	40	280
Wagon, Canada	495 kg	35	245	35	245	185R 14 S	26	180	30	210	175-14	40	280

## pg. 102 Volvo Service Manuals

Service Manuals for your Volvo are available for purchase. These are the same used by competent Volvo technicians. Each major system in the car is covered by an individual Manual. These are grouped into ten sections and placed into a binder system. (Note that manuals and binders may be obtained separately or in preassembled sets.)

Major sections within the binder system include: 0-General Information; 1-Service and Maintenance; 2-Engine; 3-Electrical System and Instruments; 4-Power Transmission; 5-Brakes; 6-Suspension and Steering; 7-Frame, Springs, Dampers and Wheels; 8-Body; 9-Accessories and Other Equipment.

A Service Manual Brochure/Order Form was placed in the car prior to delivery from the dealer to you. Complete ordering information is provided.

Please note that these manuals may be offered for sale by your Volvo dealer. Prices charged by the dealer can vary from those listed in the brochure (according to Federal law).

Additional copies of the Brochure/Order Form may be obtained from your Volvo dealer, or by mail directly from:

Volvo Cars of North America  
 Rockleigh Industrial Park  
 Rockleigh, New Jersey 07647  
 Attention: Volvo Service Literature

**Note that the above pertains to vehicles sold in the U.S.A. only. Canadian owners should contact their authorized Volvo dealer to obtain Service Manuals.**



Volvo supports Voluntary Mechanic Certification by the N.I.A.S.E. Certified mechanics have demonstrated a high degree of competence in specific areas.

Besides passing exams each mechanic must also have worked in the field for two or more years before a certificate is issued.

These professional mechanics are fully able to analyze vehicle problems and perform the necessary service procedures to keep your Volvo at peak operating condition.

**Note!** The above pertains to USA only.

pg. 103 Road assistance



Your new Volvo comes with a three year road assistance program known as ON-CALL. Additional information, features, and benefits are described in a separate information package in your glove compartment.

pg. 104 Child safety

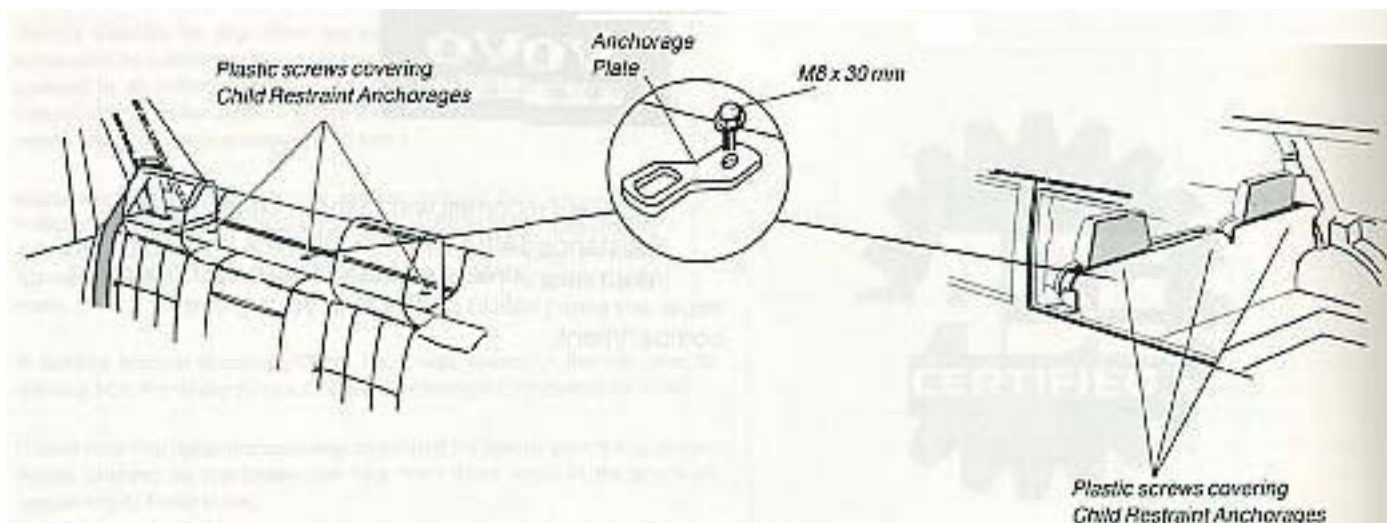

## Child Restraint Anchorages

Volvo cars are fitted with child restraint top tether anchorages in the rear seat. There are three anchorages under the rear section of the car's rear window shelf on sedans and in the back of the rear seat in wagons. When the car is delivered, the holes for these anchorages are covered by plastic screws. In cars designated for Canada, one top tether anchorage set will be in the glove box. In cars designated for the U.S., a coupon good for one set, will be provided by mail. The top tether anchorage set includes the top tether anchorage plate, an M8 bolt (30 mm long) and a plastic trim cover. If another set is needed, consult your Volvo dealer.

## Installing the top tether

Remove the plastic screw covering the anchorage point you want to use. This can be done with a suitable coin. The screw is removed counter-clockwise.

Place the top tether anchorage plate as shown in the illustration. Using the M8 bolt, tighten securely, to  $16 \pm 2.5$  ft.lbs. Place the plastic trim plate over the anchorage plate, if desired.

### **WARNING!**

Child Restraint Anchorages are designed to withstand only those loads imposed by correctly fitted Child Restraints. Under no circumstances are they to be used for adult seat belts or harnesses. The anchorages are not able to withstand excessive forces on them in the event collision if full harness seat belts or adult seat belts are installed to them.

A grown-up who uses a belt anchored in a Child Restraint Anchorage runs a great risk of suffering severe injuries should a collision occur.



[Contents](#) | [Top of Page](#)

---

# 1989 VOLVO 240

## Index - Back Page

### pg. 106-107 Index

<b>A</b>	
Air Conditioning	<a href="#">24</a>
Air louvers	<a href="#">23</a>
Alternator, important note	<a href="#">73</a>
Anti-freeze	<a href="#">72</a>
Anti-rust treatment	<a href="#">85</a>
Ash trays	<a href="#">20</a>
Automatic transmission	<a href="#">44</a>
Automatic transmission oil	<a href="#">69</a>
<b>B</b>	
Battery	<a href="#">59,100</a>
Body and chassis	<a href="#">71</a>
Brake fluid	<a href="#">59,70</a>
Brakes	<a href="#">49</a>
Break-in period	<a href="#">40</a>
Bulb failure warning light	<a href="#">11</a>
Bulbs	<a href="#">74,100</a>
<b>C</b>	
Capacities	<a href="#">100</a>
Cargo space	<a href="#">96</a>
Catalytic converter	<a href="#">50,65</a>
Chassis number	<a href="#">94</a>
Checking coolant	<a href="#">59,72</a>



Checking engine oil	<a href="#">59</a>
Child safety	<a href="#">27,104</a>
Child safety locks	<a href="#">30</a>
Cigarette lighter	<a href="#">20</a>
Climate control	<a href="#">22-24</a>
Clock	<a href="#">12</a>
Cold start	<a href="#">42</a>
Cold weather driving	<a href="#">89</a>
Control lights	<a href="#">10</a>
Coolant	<a href="#">61,72</a>
Coolant, drain	<a href="#">61</a>
Cooling system	<a href="#">61,72</a>
<b>D</b>	
Defroster	<a href="#">22-24</a>
Demister	<a href="#">18</a>
Diagnosis	<a href="#">90</a>
Dimensions and weights	<a href="#">96</a>
Dipstick	<a href="#">59</a>
Door lock anti-freeze	<a href="#">59</a>
Doors and locks	<a href="#">30</a>
Drain plug, engine	<a href="#">59</a>
Drain plug, rear axle	<a href="#">70</a>
Drive belts	<a href="#">61</a>
Driving economy	<a href="#">41</a>
Driving with trunk lid open	<a href="#">48</a>
<b>E</b>	
Electrical system	<a href="#">100</a>
Emergency towing(pulling	<a href="#">46</a>
Engine	<a href="#">57,89</a>
Engine oil	<a href="#">60,89</a>
Exhaust Gas Recirculation(EGR)	<a href="#">62</a>

**F**

Fan belts	<a href="#">61</a>
Fault Tracing	<a href="#">90</a>
Federal Clean Air Act	<a href="#">53</a>
Front seats	<a href="#">26</a>
Front wheel alignment	<a href="#">99</a>
Fuel requirements	<a href="#">58</a>
Fuel gauge	<a href="#">10</a>
Fuel tank cap	<a href="#">34</a>
Fuses	<a href="#">79</a>
<b>G</b>	
Gas filler cap	<a href="#">34</a>
Gasoline requirements	<a href="#">58</a>
Gear shift positions	<a href="#">43</a>
<b>H</b>	
Hand brake	<a href="#">19</a>
Hazard warning flasher	<a href="#">18</a>
Headlight flasher	<a href="#">14</a>
Headlights	<a href="#">15,74</a>
Headlights replacement	<a href="#">74</a>
Heating	<a href="#">22</a>
Hood lock	<a href="#">32</a>
Horn	<a href="#">8</a>
<b>I</b>	
Ignition and steering wheel lock	<a href="#">14</a>
Instrument lights	<a href="#">15</a>
Instruments and controls	<a href="#">8</a>
Interior light	<a href="#">34,70</a>
<b>J</b>	
Jack	<a href="#">82</a>
Jump starting	<a href="#">73</a>
<b>K</b>	
Keys	<a href="#">5</a>

Kick-down	<a href="#">45</a>
<b>L</b>	
Label information	<a href="#">94</a>
License plate lights	<a href="#">77</a>
Lights	<a href="#">15</a>
Locks	<a href="#">30</a>
Long distance trips	<a href="#">89</a>
Lubrication	<a href="#">71</a>
Lumbar support	<a href="#">26</a>
<b>M</b>	
Maintenance Service	<a href="#">53</a>
Manual transmission driving with	<a href="#">43</a>
Manual transmission oil	<a href="#">68</a>
<b>O</b>	
Odometer	<a href="#">10</a>
Oil change, engine	<a href="#">59-60</a>
Oil change, rear axle	<a href="#">70</a>
Oil change, transmission	<a href="#">68</a>
Oil filter	<a href="#">59</a>
Oil pressure	<a href="#">11,13</a>
On call	<a href="#">103</a>
<b>P</b>	
Paint touch-up	<a href="#">86</a>
Parking brake	<a href="#">19</a>
Parking lights	<a href="#">15</a>
Polishing	<a href="#">85</a>
Power steering fluid	<a href="#">70</a>
Power train	<a href="#">91</a>
<b>R</b>	
Radios	<a href="#">25</a>
Rear axle oil	<a href="#">70</a>
Rear foglights	<a href="#">17</a>

Rear view mirrors	<a href="#">33</a>
Rear window demister	<a href="#">18</a>
Road assistance	<a href="#">103</a>
Rustproofing	<a href="#">85</a>
Rust protection	<a href="#">85</a>
<b>S</b>	
Seat belts	<a href="#">28</a>
Seats	<a href="#">26</a>
Service diagnosis	<a href="#">90</a>
Service reminder light	<a href="#">12</a>
Servicing	<a href="#">63</a>
Shift indicator light	<a href="#">41</a>
Shift positions	<a href="#">43</a>
Shop manuals, Volvo	<a href="#">102</a>
Snow chains	<a href="#">81</a>
Snow tires	<a href="#">81</a>
Spare wheel	<a href="#">37,81</a>
Spark plugs	<a href="#">98</a>
Specifications	<a href="#">95</a>
Speedometer	<a href="#">10</a>
Starting engine	<a href="#">36</a>
Starting key	<a href="#">5</a>
Steering wheel lock	<a href="#">14</a>
Storage space	<a href="#">37</a>
Sunroof	<a href="#">34</a>
<b>T</b>	
Tachometer	<a href="#">10</a>
Tailgate (wagon)	<a href="#">36</a>
Temperature	<a href="#">10</a>
Tire pressure	<a href="#">80</a>
Tires	<a href="#">80,101</a>
Tools	<a href="#">101</a>

Touch up	<a href="#">86</a>
Towing	<a href="#">46</a>
Trailer hauling	<a href="#">48</a>
Transmission oil	<a href="#">68</a>
Trunk	<a href="#">31</a>
Turn signals	<a href="#">14</a>
Type designations	<a href="#">94</a>
<b>U</b>	
Upholstery, cleaning	<a href="#">85</a>
<b>V</b>	
Vehicle Identification Number	<a href="#">94</a>
Ventilation outlets	<a href="#">18</a>
VIN (Vehicle Identification Number)	<a href="#">94</a>
<b>W</b>	
Warning lights	<a href="#">11</a>
Warranty	<a href="#">53</a>
Washer fluid	<a href="#">17</a>
Washing	<a href="#">84</a>
Waxing	<a href="#">85</a>
Weights	<a href="#">96</a>
What causes rust	<a href="#">88</a>
Wheel alignment	<a href="#">99</a>
Wheel change	<a href="#">82</a>
Wheels and tires	<a href="#">80</a>
Window lifts	<a href="#">21</a>
Windshield washers	<a href="#">16</a>
Windshield wipers	<a href="#">16</a>
Winter driving	<a href="#">89</a>
Wiper blades, replacement	<a href="#">84</a>

Back Cover



Fuel: Octane rating 91 RON Unleaded, 87 (R+M)/2

**When refueling always check:**

- A. Oil level between dipstick marks. The distance between the marks represents approx. 1 US qt. = 1 liter. Fill with multigrade oil
  - B. Check without removing the cap that the brake fluid level is above the Min-mark. Brake and clutch fluid DOT 4.
  - C. Coolant level between the expansion tank marks. Mixture: 50 percent anti-freeze and 50 percent water.
  - D. Washer fluid reservoir should be filled with water and solvent (wintertime: windshield washer anti-freeze).
  - E. Electrolyte level 1/4" -3/8" (5-10 mm) above plates. Fill (distilled water) only, never acid. Check level in conjunction with normal service or once a year. Never operate engine in closed unventilated areas.
- Changing a wheel, [see pages 82-83](#)  
a bulb, [see pages 74-78](#)  
a fuse, [see page 79](#)

**WARNING!**

Detergents and solvents

Do not use gasoline containing lead or benzene as a detergent or solvent. Both lead and benzene are toxic and may be hazardous to your health.

**WARNING!**

Carbon monoxide is a poisonous colorless and odorless gas which is present in all exhaust gases. If you ever smell exhaust fumes inside the vehicle, make sure the passenger compartment is ventilated and immediately return the vehicle to dealer for correction.

**Never** sit in a parked or stopped car for any extended amount of time, nor have it unattended while engine is running.

**Never** operate the engine in confined, unventilated areas.



[Contents](#) | [Top of Page](#)

---